

# SCIENTIFIC REPORTS



OPEN

## The vertical distribution and biological transport of marine microplastics across the epipelagic and mesopelagic water column

Received: 12 December 2018

Accepted: 7 May 2019

Published online: 06 June 2019

C. Anela Choy<sup>1,5</sup>, Bruce H. Robison<sup>1</sup>, Tyler O. Gagne<sup>2</sup>, Benjamin Erwin<sup>1</sup>, Evan Firl<sup>2</sup>, Rolf U. Halden<sup>3</sup>, J. Andrew Hamilton<sup>1</sup>, Kakani Katija<sup>1</sup>, Susan E. Lisin<sup>2</sup>, Charles Rolsky<sup>3</sup> & Kyle S. Van Houtan<sup>2,4</sup>

Plastic waste has been documented in nearly all types of marine environments and has been found in species spanning all levels of marine food webs. Within these marine environments, deep pelagic waters encompass the largest ecosystems on Earth. We lack a comprehensive understanding of the concentrations, cycling, and fate of plastic waste in sub-surface waters, constraining our ability to implement effective, large-scale policy and conservation strategies. We used remotely operated vehicles and engineered purpose-built samplers to collect and examine the distribution of microplastics in the Monterey Bay pelagic ecosystem at water column depths ranging from 5 to 1000 m. Laser Raman spectroscopy was used to identify microplastic particles collected from throughout the deep pelagic water column, with the highest concentrations present at depths between 200 and 600 m. Examination



POLICY

SCIENCE

COMMS



Monterey Bay Aquarium®

PROBLEM



a

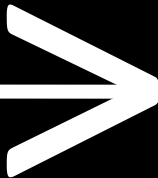
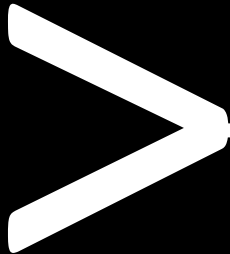

b







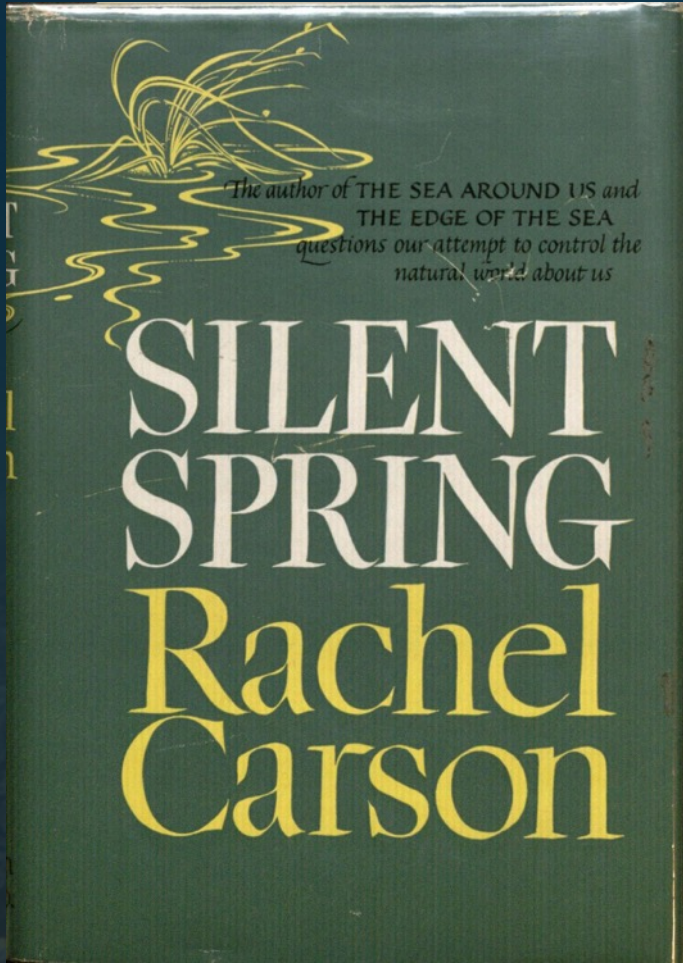

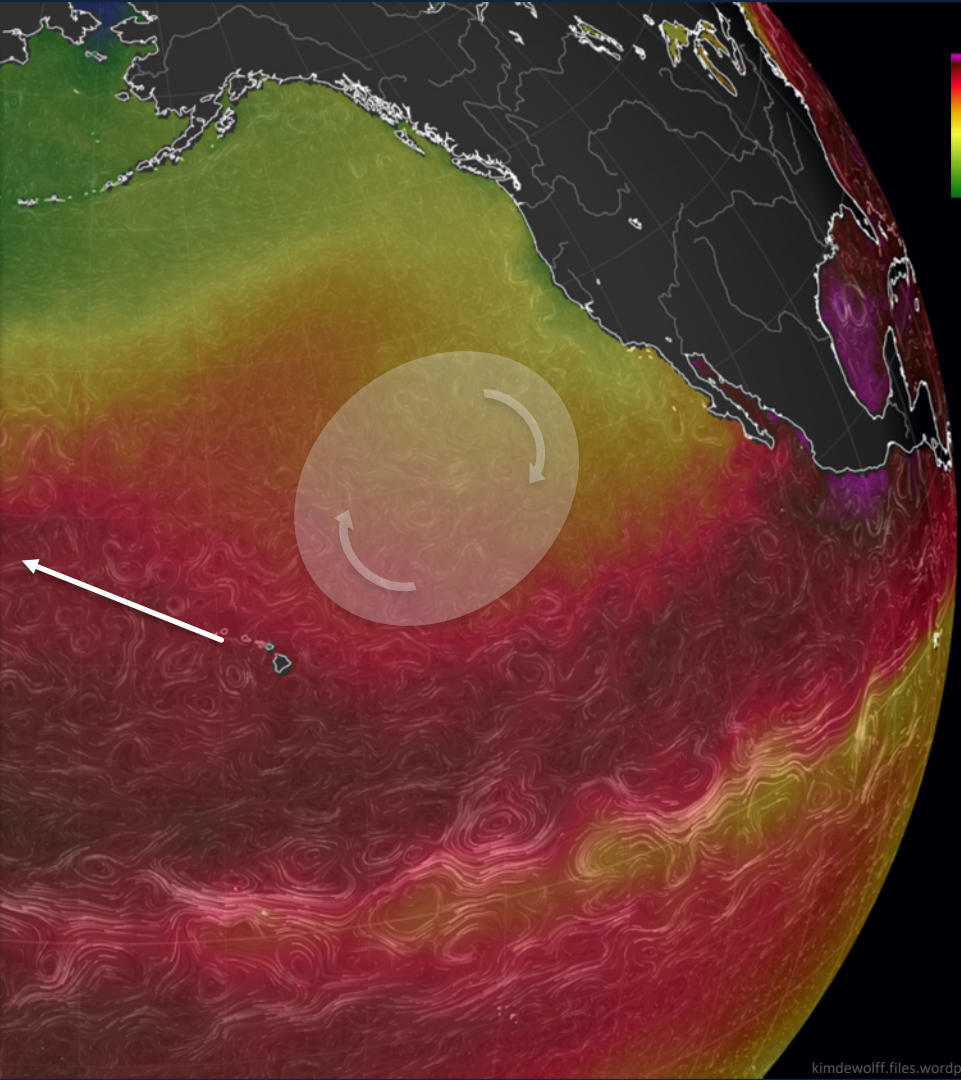
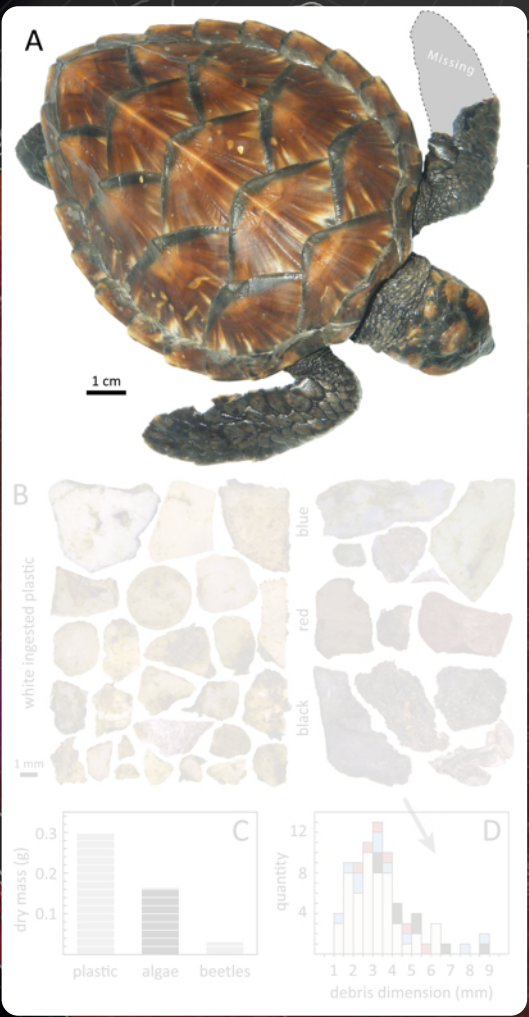



- 
- A close-up photograph of a person's hand holding a large quantity of microplastic debris. The debris consists of numerous small, colorful fragments of plastic in shades of blue, green, yellow, and white, mixed with fine sand. The background shows a beach with more sand and scattered plastic litter. A semi-transparent dark grey rounded rectangle is overlaid on the center of the image, containing a numbered list of five items.
- 1. Entanglement**
  - 2. GI tract blockage**
  - 3. Caloric loss**
  - 4. Material toxins**
  - 5. Surface toxins**



M B A R I



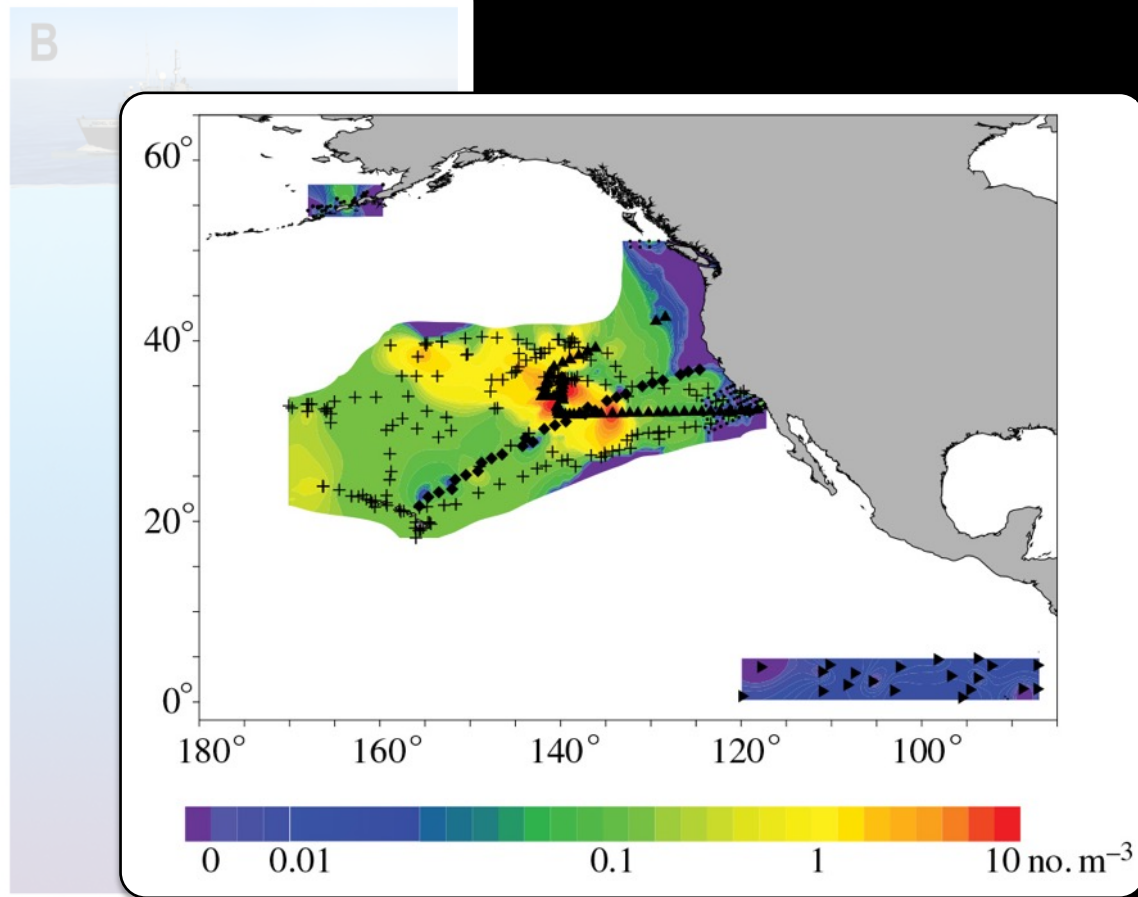
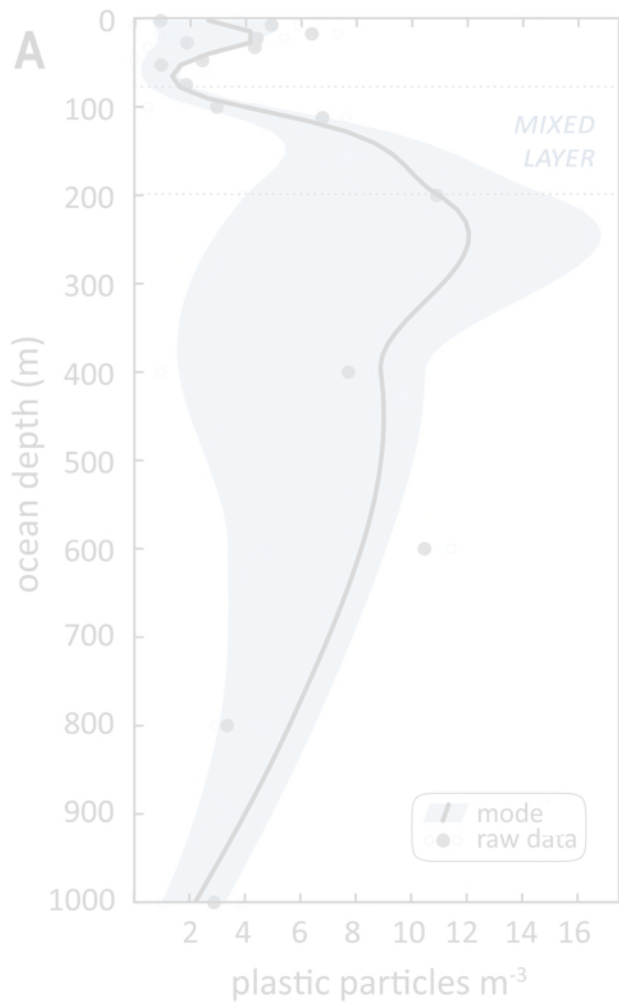

Goldstein et al. 2013

Choy et al. 2019



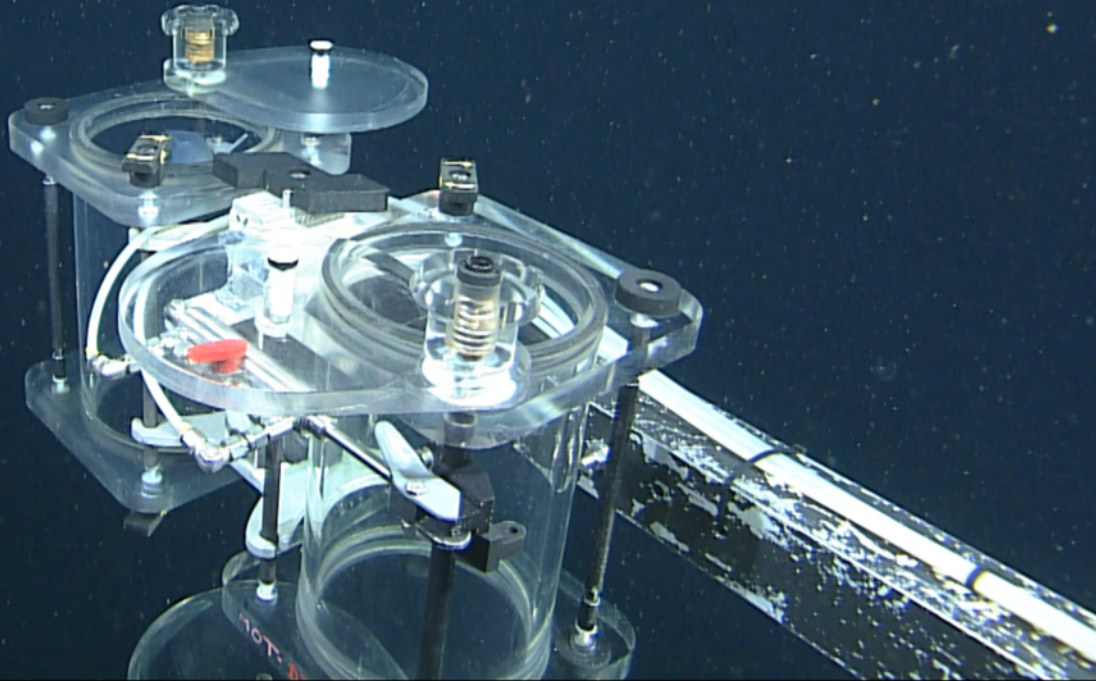
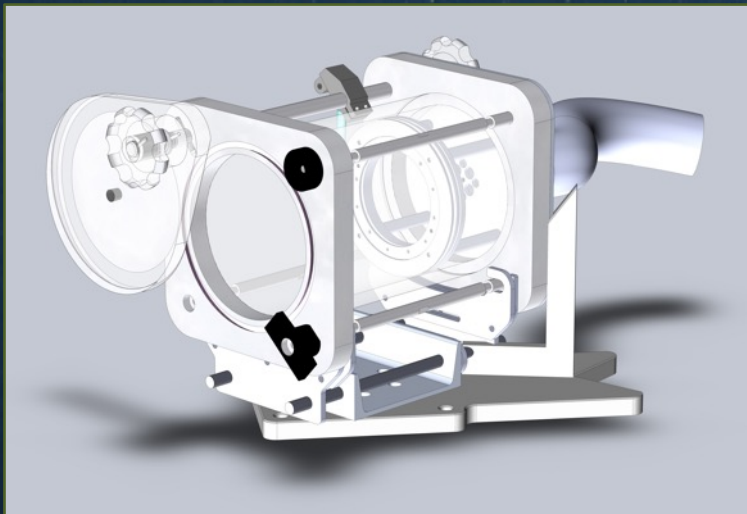



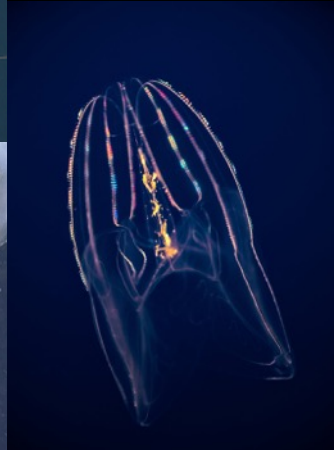
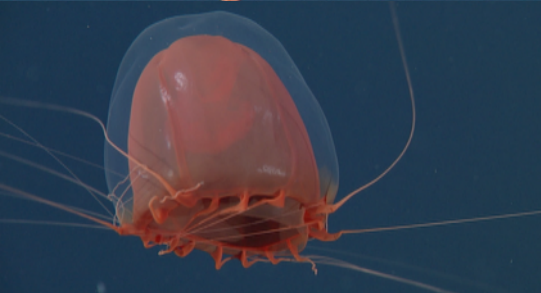

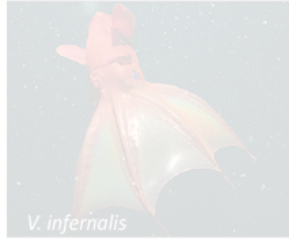
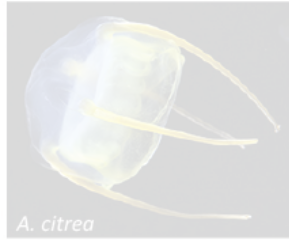
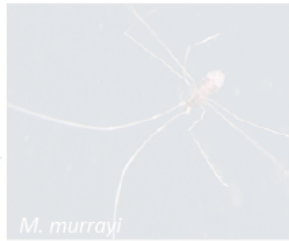
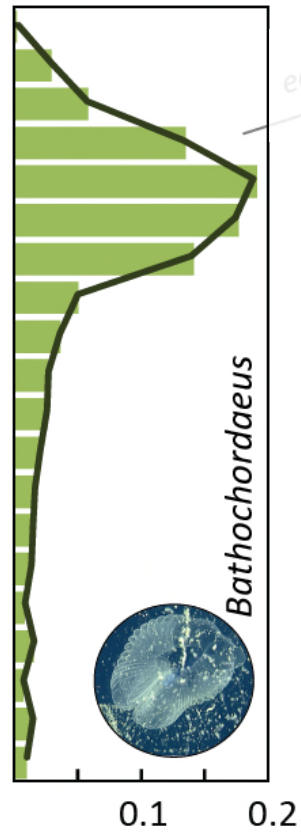
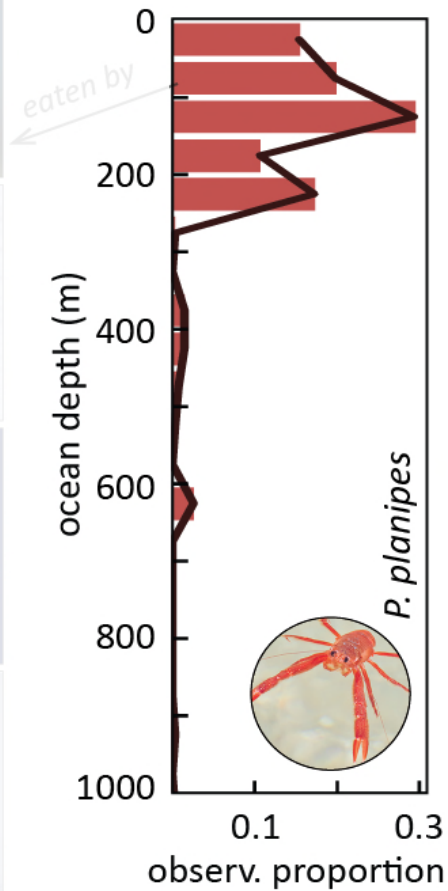



1.00mi

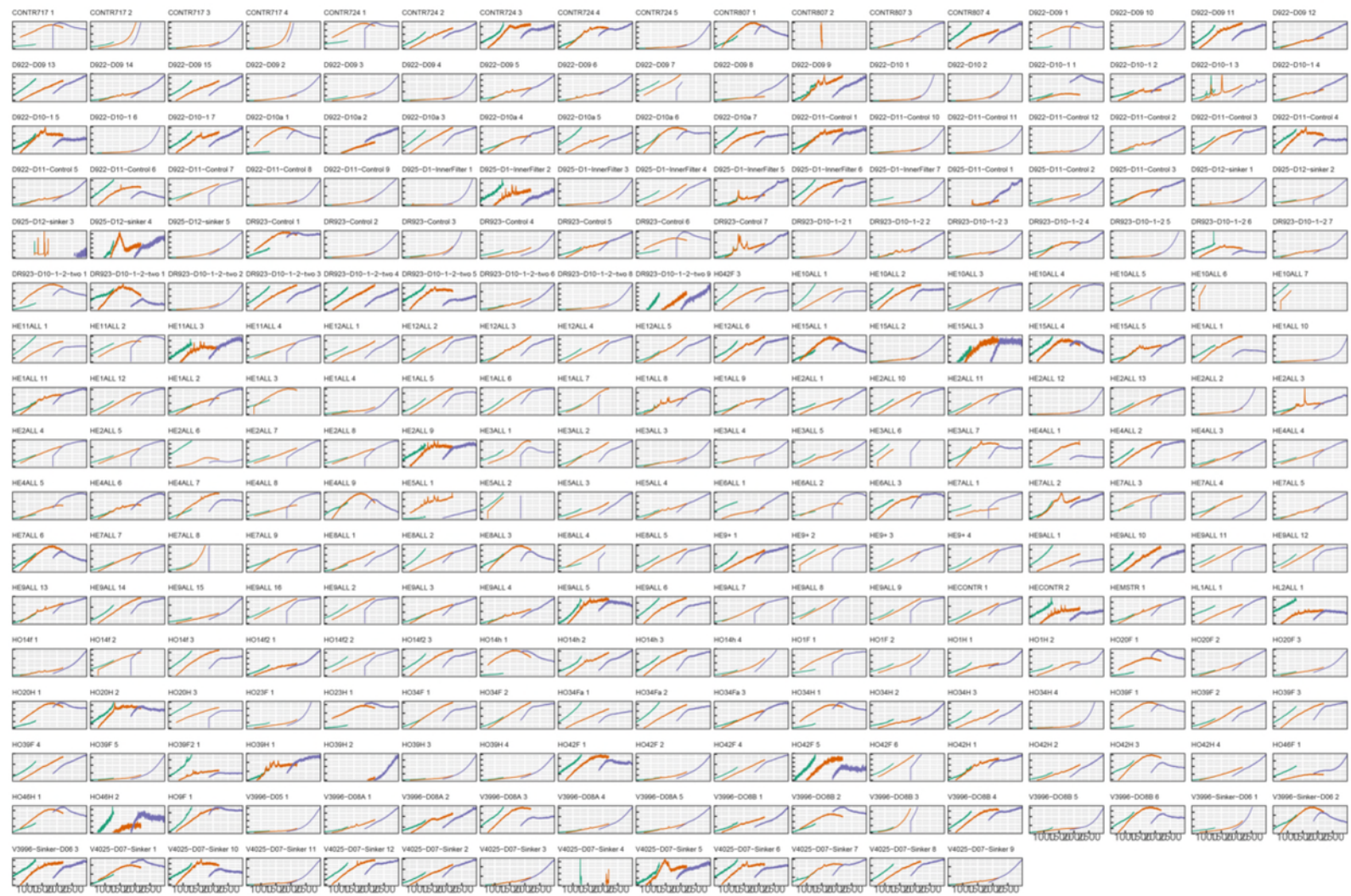

WAVE



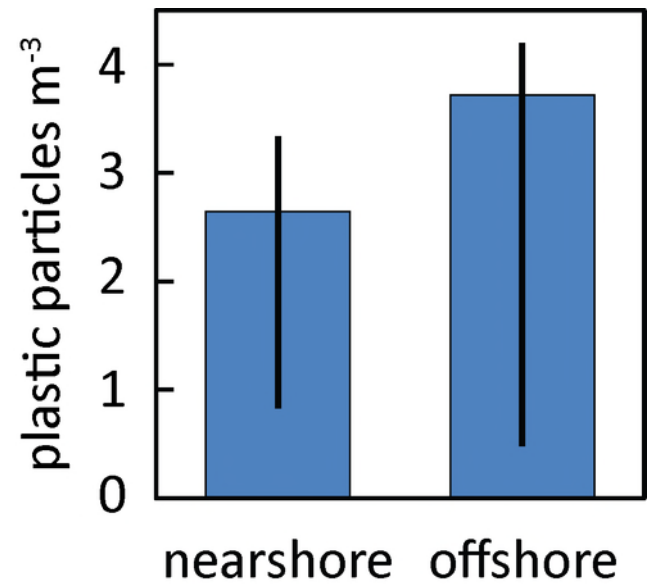
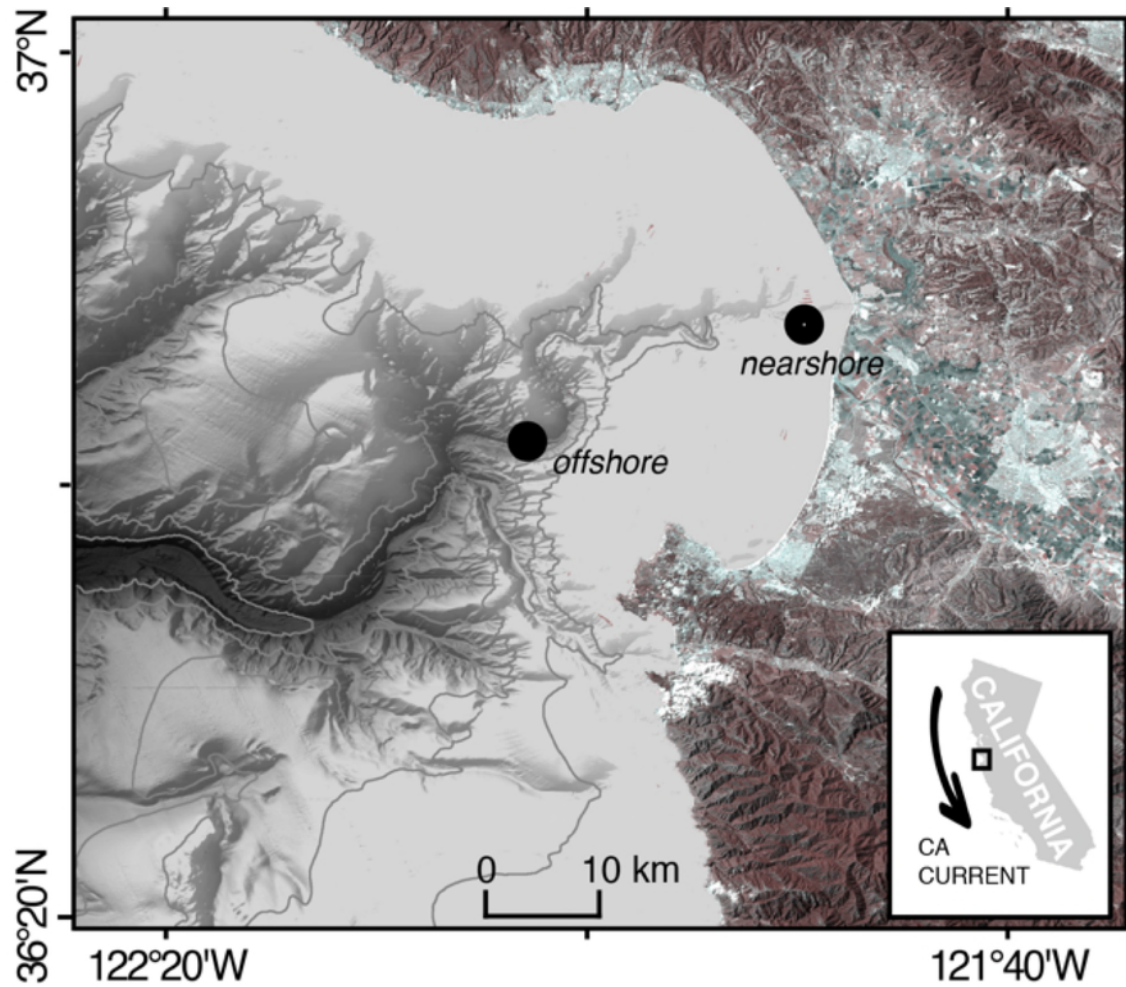

water

*P. planipes*

*Bathochordaeus*

fishery gear

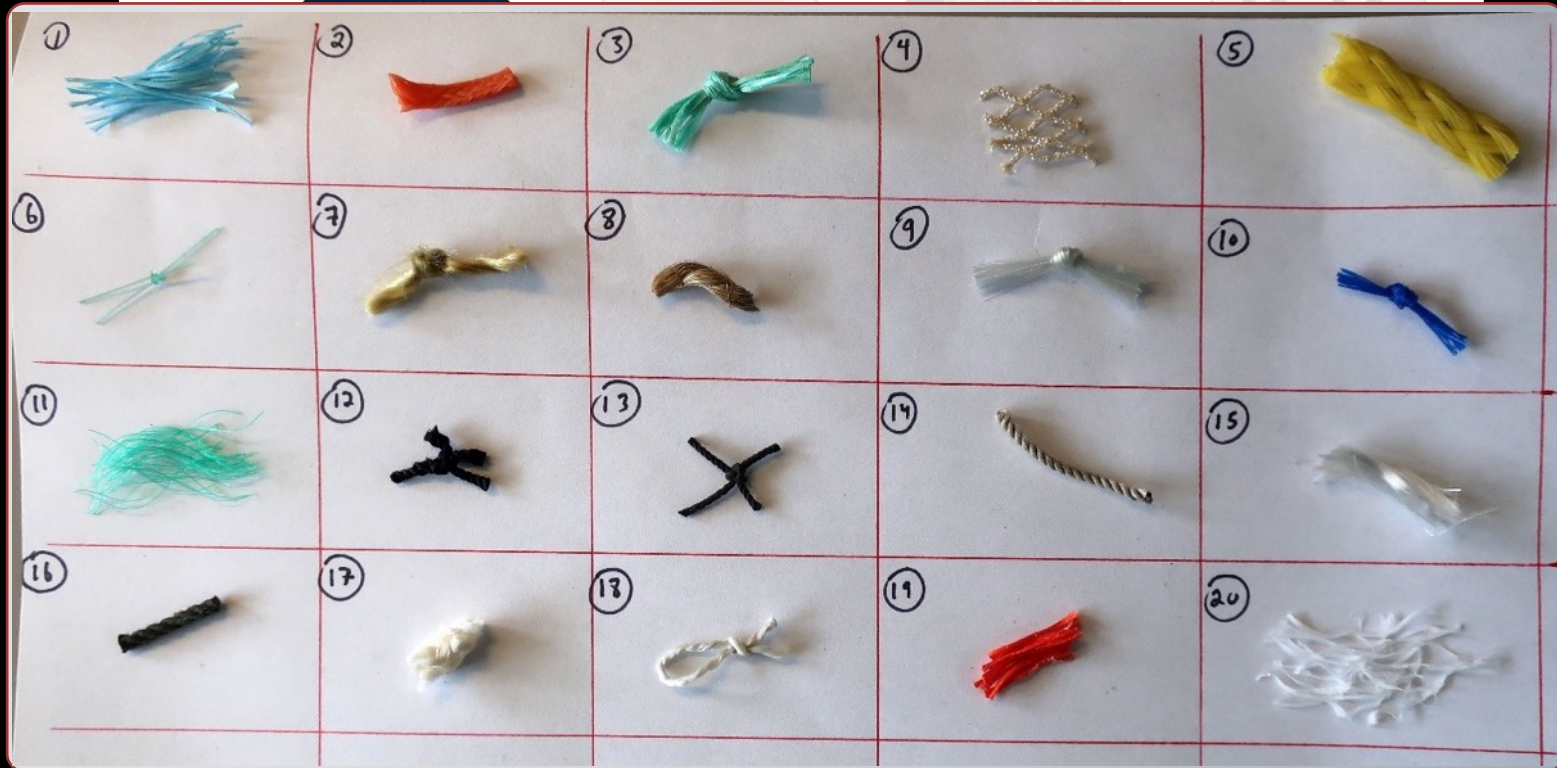

0 0.2 0.4  
proportion

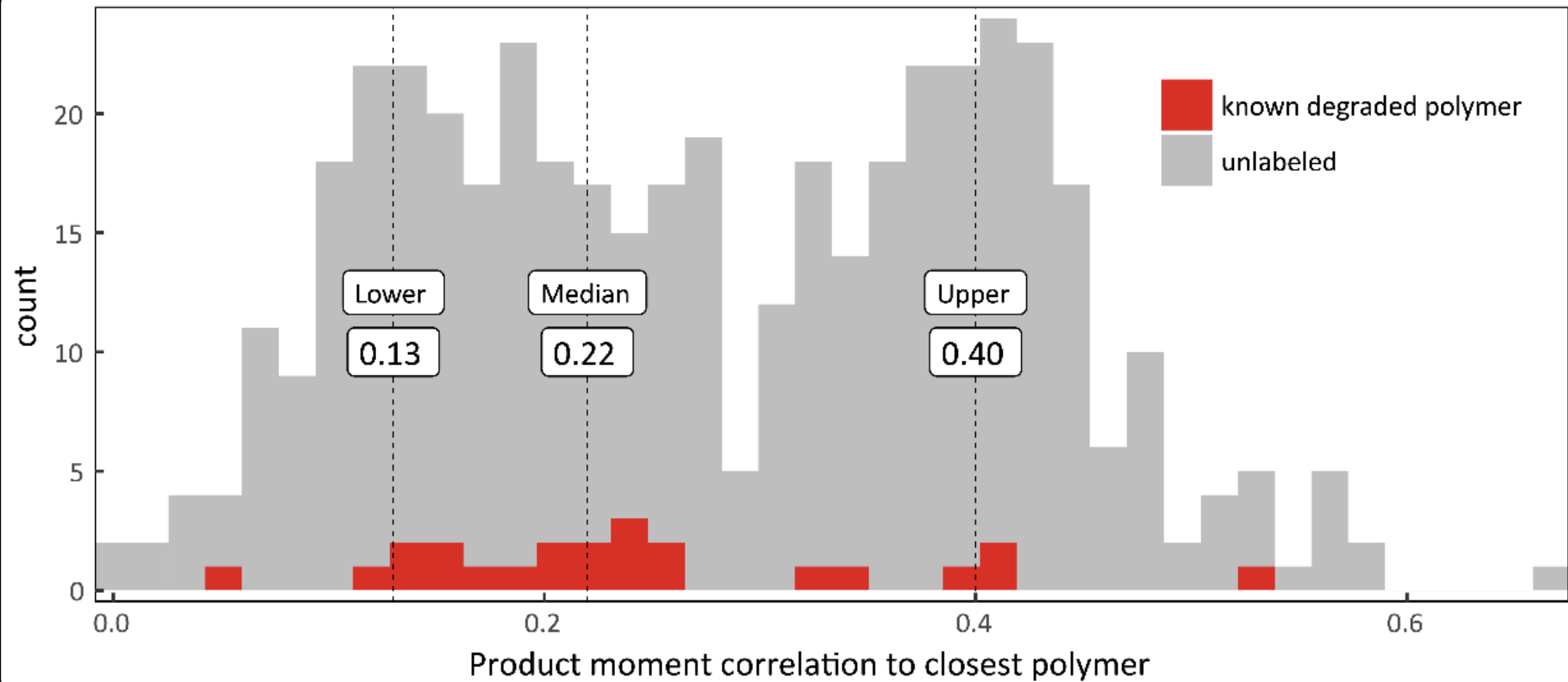



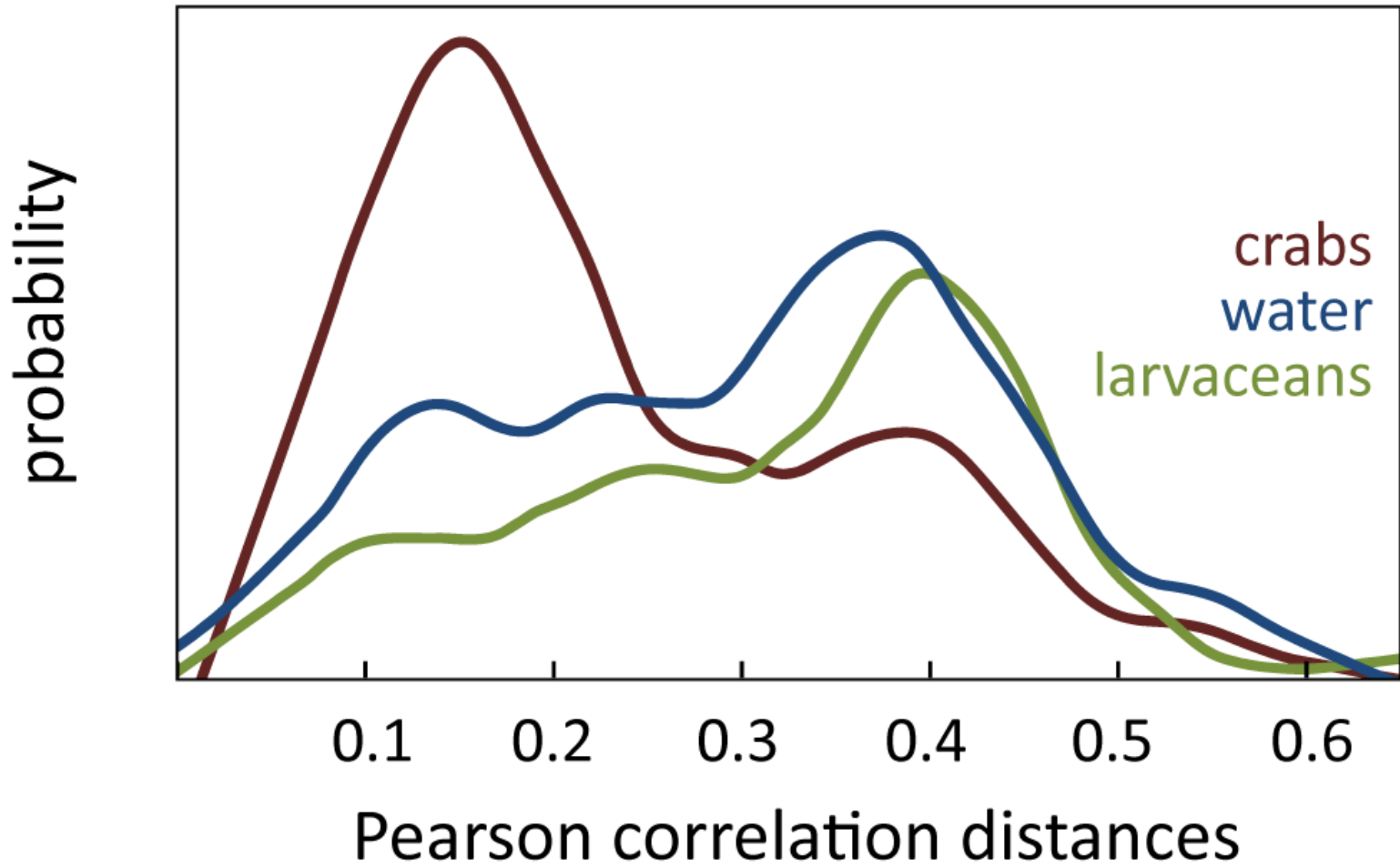

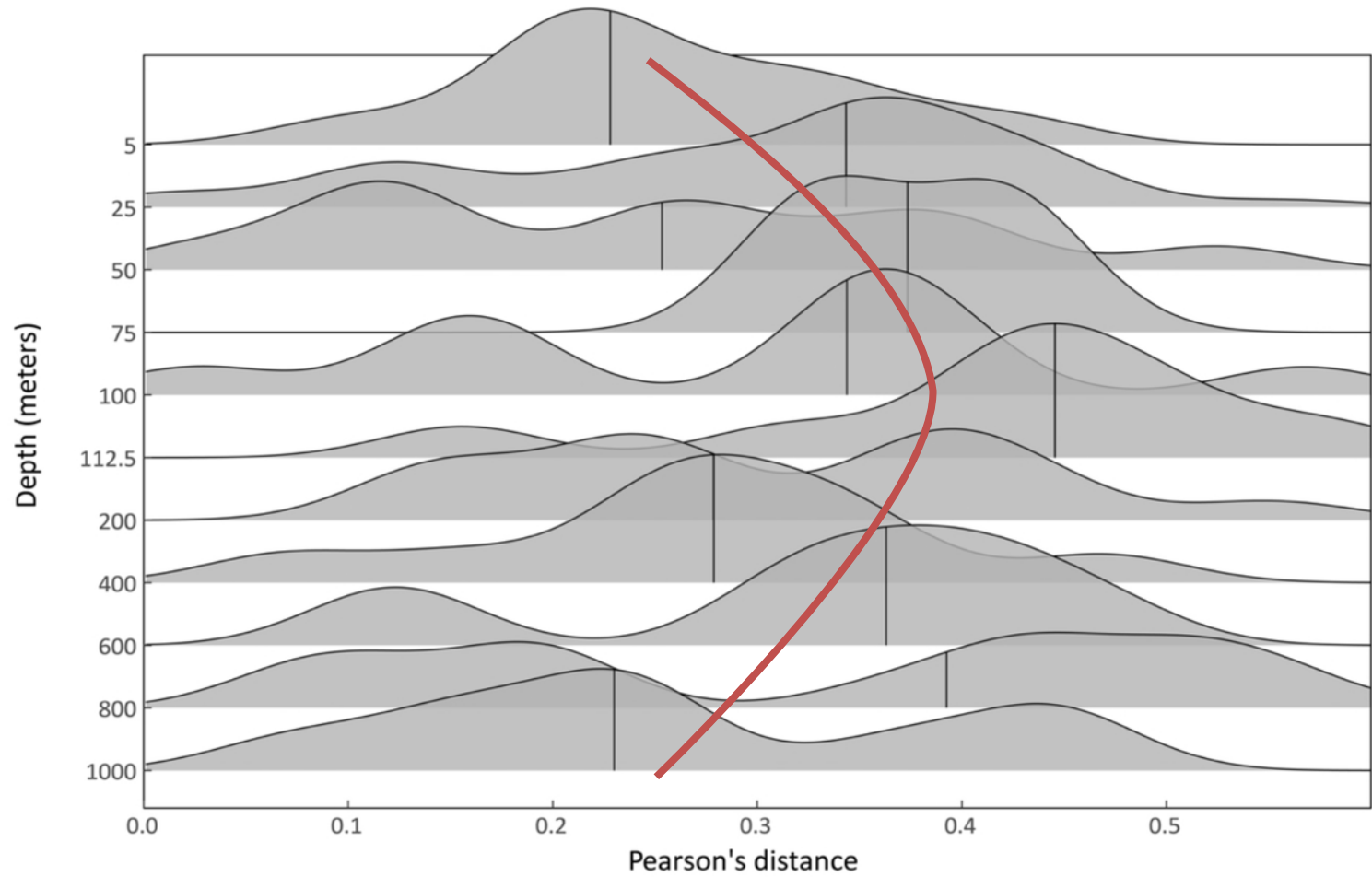



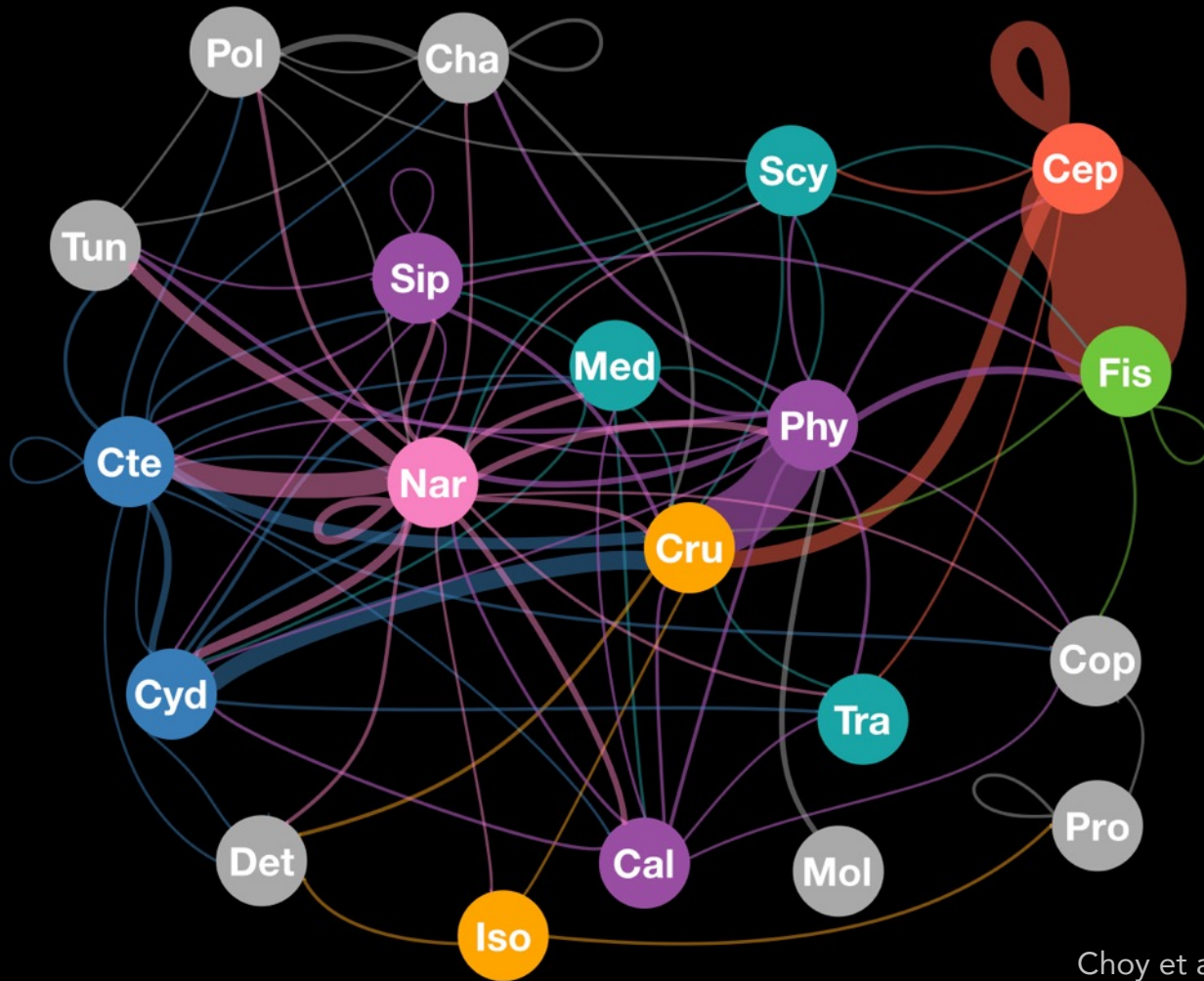

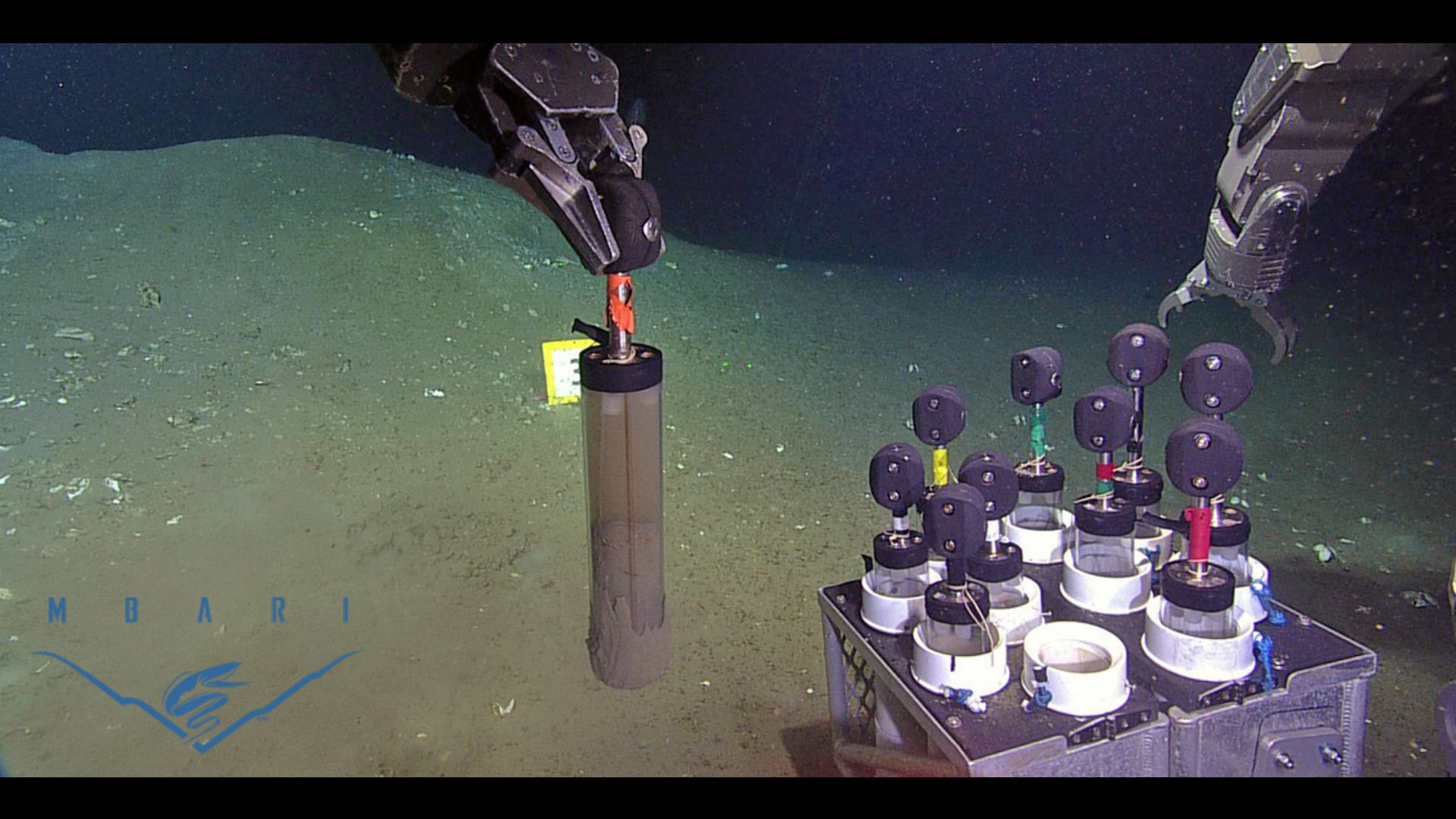



M B A R I



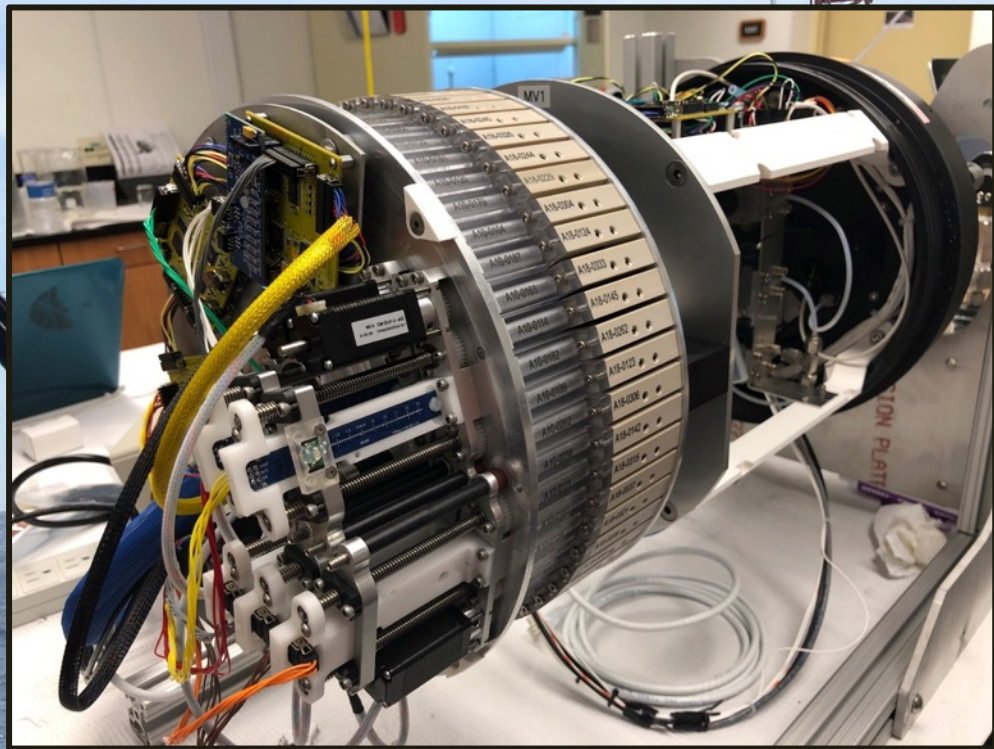





A photograph of two men, Richard Feynman and Neil Armstrong, seated at a long wooden table during a press conference. Richard Feynman, on the left, is wearing a dark pinstriped suit, a white shirt, and a grey tie. He has grey hair and is wearing glasses. He is gesturing with his right hand, pointing his index finger upwards. Neil Armstrong, on the right, is wearing a dark suit, a light blue shirt, and a dark tie. He has dark hair and is wearing glasses. He is looking down and has his hands clasped near his face. In front of them are several microphones and a large glass of water with a red cap. The background is dark and out of focus, with some people and equipment visible. The nameplates in front of them are white with black text.

**RICHARD FEYNMAN**

**NEIL ARMSTRONG**



