

APPENDIX E

**Monterey Peninsula Water Supply Project Monitoring Well Completion Report and CEMEX Model
Update (TM-2)**

Monterey Peninsula Water Supply Project Hydrogeologic Investigation

Technical Memorandum (TM2) Monitoring Well Completion Report and CEMEX Model Update

Part 1 of 2:
Text, Figures, and Tables

PREPARED FOR:
California American Water

February 8, 2017

GEOSCIENCE Support Services, Inc., **Ground Water Resources Development**
P.O. Box 220, Claremont, CA 91711 | P (909) 451-6650 | F (909) 451-6638 | www.gssiwater.com

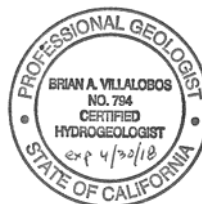


THIS REPORT IS RENDERED TO CALIFORNIA AMERICAN WATER AS OF THE DATE HEREOF, SOLELY FOR THEIR BENEFIT IN CONNECTION WITH ITS STATED PURPOSE AND MAY NOT BE RELIED ON BY ANY OTHER PERSON OR ENTITY OR BY THEM IN ANY OTHER CONTEXT. ALL CALCULATIONS WERE PERFORMED USING ACCEPTED PROFESSIONAL STANDARDS.

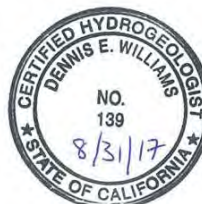
AS DATA IS UPDATED FROM TIME TO TIME, ANY RELIANCE ON THIS REPORT AT A FUTURE DATE SHOULD TAKE INTO ACCOUNT UPDATED DATA.



Brian Villalobos, PG, CEG, CHG
Principal
CHG No. 794



Dennis E. Williams, Ph.D., PG, CHG
President
CHG No. 139



In Cooperation with the Monterey Peninsula Water Supply Project
Hydrogeology Working Group:

Mr. Tim Durbin
Mr. Martin Feeny, CEG, CHG
Mr. Peter Leffler, CHG
Dr. Dennis Williams, CHG

Copyright © 2017 GEOSCIENCE Support Services, Inc.

GEOSCIENCE retains its copyrights, and the client for which this document was produced may not use such products of consulting services for purposes unrelated to the subject matter of this project. No portion of this report may be reproduced, stored in a retrieval system, or transmitted in any form or by any means, mechanical, electronic, photocopying, recording or otherwise EXCEPT for purposes of the project for which this document was produced.

**MONTEREY PENINSULA WATER SUPPLY PROJECT
HYDROGEOLOGIC INVESTIGATION
TECHNICAL MEMORANDUM (TM 2):
MONITORING WELL COMPLETION REPORT AND CEMEX MODEL UPDATE**

**PREPARED FOR
CALIFORNIA AMERICAN WATER**

CONTENTS

1.0	INTRODUCTION.....	1
1.1	Purpose and Scope	1
1.2	Monitoring Well Requirement	1
1.3	Monitoring Well Locations and Construction Information	2
1.3.1	On-Site Monitoring Wells	3
1.3.2	Off-Site Monitoring Wells.....	4
2.0	DRILLING, TESTING, AND MONITORING WELL INSTALLATION.....	6
2.1	Borehole Drilling and Soil Sampling	6
2.2	Geophysical Logging	7
2.3	Monitoring Well Construction.....	7
2.3.1	Casing and Screen.....	8
2.3.2	Filter Pack and Annular Seal	8
2.4	Well Development.....	10
2.5	Water Quality Sampling.....	10
2.5.1	Monitoring Well Instrumentation	10
2.6	Surface Completion	12

3.0	UPDATED HYDROGEOLOGIC CONCEPTUAL MODEL.....	13
3.1	CEMEX	13
3.1.1	Dune Sand Aquifer.....	13
3.1.2	180-Foot Equivalent (180-FTE) Aquifer	14
3.2	Marina Landfill Area	14
3.2.1	35-Foot Aquifer.....	17
3.2.2	Fort Ord Salinas Valley Aquitard (FO-SVA)	17
3.2.3	-2-Foot Aquifer	17
3.2.4	180-FTE	18
3.3	Fort Ord Area.....	18
3.3.1	Fort Ord “A” Aquifer (Old Dune Sand).....	18
3.3.2	Fort Ord Salinas Valley Aquitard (FO-SVA)	18
3.3.3	180-FTE	18
3.4	Salinas Valley	19
3.4.1	Salinas Valley “A” Aquifer	19
3.4.2	Salinas Valley Aquitard (SVA).....	19
3.4.3	180-Foot Aquifer.....	19
3.5	Entire Study Area.....	20
3.5.1	180/400-Foot Aquitard.....	20
3.5.2	400-Foot Aquifer.....	20
3.5.3	Paso Robles Formation	20
3.6	Summary of Geohydrologic Conditions.....	21
4.0	GROUNDWATER ELEVATIONS AND WATER QUALITY.....	22
4.1	Groundwater Elevations.....	22
4.1.1	Monterey Peninsula Water Supply Project Monitoring Network Wells	22
4.1.2	Monterey County Pollution Control Agency Monterey Landfill Monitoring Wells	22

4.1.3	Fort Ord Monitoring Network Wells.....	23
4.1.4	Groundwater Elevations by Aquifer	24
4.1.4.1	“A” Aquifer	24
4.1.4.2	Dune Sand Aquifer	24
4.1.4.3	180-FTE/180-Foot Aquifer.....	25
4.1.4.4	400-Foot Aquifer	25
4.1.5	Summary of Groundwater Elevations	26
4.2	Water Quality Sampling.....	26
4.3	Groundwater Quality – Electrical Conductivity (EC) and Total Dissolved Solids (TDS)	27
5.0	CEMEX MODEL UPDATE	29
5.1	Conceptual Model	29
5.2	Updated CEMEX Model	30
5.2.1	Aquifer Characteristics	30
5.2.1.1	Model Layer Elevations	30
5.2.1.2	Hydraulic Conductivity	30
5.2.1.3	Storativity	31
5.2.2	Model Calibration	32
5.2.2.1	Calibration Approach	32
5.2.2.2	Calibration Process.....	32
5.2.2.3	Calibration Results.....	34
5.2.3	Model Sensitivity	35
6.0	REFERENCES.....	37

FIGURES, TABLES AND APPENDICES

FIGURES

No.	Description
1	Test Slant Well and Monitoring Well Locations
2	Regional Location Map Showing Well and Cross-Section Locations
3	Cross-Section 1A-1A'
4	Cross-Section 1B-1B'
5	Cross-Section 2-2'
6	Cross-Section 3-3'
7	Cross-Section 4-4'
8	Illustration of Aquifer Zones
9	Groundwater Elevations – "Perched/Mounded Aquifer" (Using Fort Ord "A" Aquifer Wells, MRWMD 35-Foot Aquifer Wells, and MPWSP MW-5S(P)) Fall 2015
10	Groundwater Elevations – "Perched/Mounded Aquifer" (Using Fort Ord "A" Aquifer Wells, MRWMD 35-Foot Aquifer Wells, and MPWSP MW-5S(P)) Spring 2016
11	Groundwater Elevations – "Dune Sand Aquifer" (Using MRWMD -2-Foot Aquifer Wells and MPWSP Shallow Completions) Fall 2015
12	Groundwater Elevations – "Dune Sand Aquifer" (Using MRWMD -2-Foot Aquifer Wells and MPWSP Shallow Completions) Spring 2016
13	Groundwater Elevations – "180-FTE/180-Foot Aquifer" (Using Fort Ord Upper 180-Foot Aquifer Wells and MPWSP Middle Completions) Fall 2015
14	Groundwater Elevations – "180-FTE/180-Foot Aquifer" (Using Fort Ord Upper 180-Foot Aquifer Wells and MPWSP Middle Completions) Spring 2016
15	Groundwater Elevations – "400-Foot Aquifer" (Using Fort Ord 400-Foot Aquifer Wells and MPWSP Deep Completions) Fall 2015
16	Groundwater Elevations – "400-Foot Aquifer" (Using Fort Ord 400-Foot Aquifer Wells and MPWSP Deep Completions) Spring 2016

FIGURES (continued)

No.	Description
17	Groundwater Model Boundaries
18	CEMEX Model Grid
19	Updated Thickness of the Dune Sand Aquifer (CEMEX Model Layers 2-4)
20	Updated Thickness of the 180-FTE Aquifer (CEMEX Model Layers 6-8)
21	Updated Thickness of the 180/400-FT Aquitard (CEMEX Model Layer 9)
22	Updated Thickness of the 400-FT Aquifer (CEMEX Model Layer 10)
23	Updated Thickness of the 400/900-FT Aquitard (CEMEX Model Layer 11)
24	Updated Thickness of the 900-FT Aquifer (CEMEX Model Layer 12)
25	Calibrated Horizontal Hydraulic Conductivity of the CM
26	Calibrated Vertical Hydraulic Conductivity of the CM
27	Calibration Target Wells
28	Groundwater Pumping during Model Calibration Period (22-Apr-15 through 13-Jan-16)
29	Drawdown Calculation for MW-1S
30	Drawdown Calculation for MW-1M
31	Drawdown Calculation for MW-3S
32	Drawdown Calculation for MW-3M
33	Drawdown Calculation for MW-4S
34	Drawdown Calculation for MW-4M
35	Drawdown Calculation for MW-7S
36	Drawdown Calculation for MW-7M
37	Transient Calibration Hydrographs of Selected Wells – Dune Sand Aquifer

FIGURES (continued)

No.	Description
38	Transient Calibration Hydrographs of Selected Wells – 180-FTE Aquifer
39	Comparison of Measured Versus Model-Calculated Drawdowns – Transient Model Calibration (22-Apr-15 through 13-Jan-16) – All Calibration Wells
40	Histogram of Drawdown Residuals – Transient Model Calibration (22-Apr-15 through 13-Jan-16) – All Calibration Wells
41	Drawdown Residuals through Time – Transient Model Calibration (22-Apr-15 through 13-Jan-16) – All Calibration Wells
42	Comparison of Measured Versus Model-Calculated Drawdowns – Transient Model Calibration (22-Apr-15 through 13-Jan-16) – MW-1S
43	Comparison of Measured Versus Model-Calculated Drawdowns – Transient Model Calibration (22-Apr-15 through 13-Jan-16) – MW-1M
44	Comparison of Measured Versus Model-Calculated Drawdowns – Transient Model Calibration (22-Apr-15 through 13-Jan-16) – MW-3S
45	Comparison of Measured Versus Model-Calculated Drawdowns – Transient Model Calibration (22-Apr-15 through 13-Jan-16) – MW-3M
46	Comparison of Measured Versus Model-Calculated Drawdowns – Transient Model Calibration (22-Apr-15 through 13-Jan-16) – MW-4S
47	Comparison of Measured Versus Model-Calculated Drawdowns – Transient Model Calibration (22-Apr-15 through 13-Jan-16) – MW-4M
48	Comparison of Measured Versus Model-Calculated Drawdowns – Transient Model Calibration (22-Apr-15 through 13-Jan-16) – MW-7S
49	Comparison of Measured Versus Model-Calculated Drawdowns – Transient Model Calibration (22-Apr-15 through 13-Jan-16) – MW-7M
50	Histogram of Drawdown Residuals – Transient Model Calibration (22-Apr-15 through 13-Jan-16) – MW-1S
51	Histogram of Drawdown Residuals – Transient Model Calibration (22-Apr-15 through 13-Jan-16) – MW-1M

FIGURES (continued)

No.	Description
52	Histogram of Drawdown Residuals – Transient Model Calibration (22-Apr-15 through 13-Jan-16) – MW-3S
53	Histogram of Drawdown Residuals – Transient Model Calibration (22-Apr-15 through 13-Jan-16) – MW-3M
54	Histogram of Drawdown Residuals – Transient Model Calibration (22-Apr-15 through 13-Jan-16) – MW-4S
55	Histogram of Drawdown Residuals – Transient Model Calibration (22-Apr-15 through 13-Jan-16) – MW-4M
56	Histogram of Drawdown Residuals – Transient Model Calibration (22-Apr-15 through 13-Jan-16) – MW-7S
57	Histogram of Drawdown Residuals – Transient Model Calibration (22-Apr-15 through 13-Jan-16) – MW-7M
58	Drawdown Residuals through Time – Transient Model Calibration (22-Apr-15 through 13-Jan-16) – MW-1S
59	Drawdown Residuals through Time – Transient Model Calibration (22-Apr-15 through 13-Jan-16) – MW-1M
60	Drawdown Residuals through Time – Transient Model Calibration (22-Apr-15 through 13-Jan-16) – MW-3S
61	Drawdown Residuals through Time – Transient Model Calibration (22-Apr-15 through 13-Jan-16) – MW-3M
62	Drawdown Residuals through Time – Transient Model Calibration (22-Apr-15 through 13-Jan-16) – MW-4S Drawdown Residuals through Time – Transient Model Calibration (22-Apr-15 through 13-Jan-16) – MW-4M
63	Drawdown Residuals through Time – Transient Model Calibration (22-Apr-15 through 13-Jan-16) – MW-7S

FIGURES (continued)

No.	Description
64	Drawdown Residuals through Time – Transient Model Calibration (22-Apr-15 through 13-Jan-16) – MW-7M
66a	Selected Hydrographs for Dune Sand Aquifer – Sensitivity Run: Storativity of Dune Sand Aquifer
66b	Selected Hydrographs for 180-FTE Aquifer – Sensitivity Run: Storativity of Dune Sand Aquifer
67a	Selected Hydrographs for Dune Sand Aquifer – Sensitivity Run: Storativity of 180-FTE Aquifer
67b	Selected Hydrographs for 180-FTE Aquifer – Sensitivity Run: Storativity of 180-FTE Aquifer
68a	Selected Hydrographs for Dune Sand Aquifer – Sensitivity Run: Horizontal Hydraulic Conductivity of Dune Sand Aquifer
68b	Selected Hydrographs for 180-FTE Aquifer – Sensitivity Run: Horizontal Hydraulic Conductivity of Dune Sand Aquifer
69a	Selected Hydrographs for Dune Sand Aquifer – Sensitivity Run: Horizontal Hydraulic Conductivity of 180-FTE Aquifer
69b	Selected Hydrographs for 180-FTE Aquifer – Sensitivity Run: Horizontal Hydraulic Conductivity of 180-FTE Aquifer
70a	Selected Hydrographs for Dune Sand Aquifer – Sensitivity Run: Vertical Hydraulic Conductivity of Dune Sand Aquifer
70b	Selected Hydrographs for 180-FTE Aquifer – Sensitivity Run: Vertical Hydraulic Conductivity of Dune Sand Aquifer
71a	Selected Hydrographs for Dune Sand Aquifer – Sensitivity Run: Vertical Hydraulic Conductivity of 180-FTE Aquifer
71b	Selected Hydrographs for 180-FTE Aquifer – Sensitivity Run: Vertical Hydraulic Conductivity of 180-FTE Aquifer

FIGURES (continued)

No.	Description
72a	Selected Hydrographs for Dune Sand Aquifer – Sensitivity Run: Vertical Hydraulic Conductivity of Ocean Floor Sediments
72b	Selected Hydrographs for 180-FTE Aquifer – Sensitivity Run: Vertical Hydraulic Conductivity of Ocean Floor Sediments
73	Summary of Calibration and Sensitivity Runs

FIGURES

No.	Description	Page
<hr/>		
	(Inset in Text)	
2-1	Downhole Water Level and Pressure Transducer	11
2-2	Example Surface Completion at MW-3M	12
3-1	Generalized Soil and Groundwater Conditions in the Monterey Peninsula Landfill Upland Plateau.....	15
3-2	Aquifers in the Vicinity of the Monterey Peninsula Landfill	16
5-1	Schematic of the Conduit Flow Process (CFP) in MODFLOW (from Shoemaker et al., 2007)	33

TABLES

No.	Description
1	Monitoring Well Information Table
2	Summary of Monitoring Well Laboratory Results – First Sampling Event

TABLES

No.	Description	Page
(Inset in Text)		
1-1	On-Site Monitoring Well Summary.....	3
1-2	Off-Site Monitoring Well Summary	5
2-1	CEMEX Lapis Lustre #3 Gradation Filter Pack	8
2-2	CEMEX Lapis Lustre #60 Mesh Fine Sand	9
4-1	Field- and Laboratory-Measured EC and TDS	28
5-1	Correlation of Hydrostratigraphic Units with CM Layers.....	29
5-2	Calibrated Storativity Values	32
5-3	Parameters Analyzed During Sensitivity Analysis	35

APPENDICES

Ltr.	Description
A	Coastal Development Permit
B	County Well Permits
C	Monitoring Well Information
D	Well Logs Used for Cross-Sections
E	Fort Ord Monitoring Wells – Water Levels used for Contours
F	Water Quality Data – Initial Samples following Development

**MONTEREY PENINSULA WATER SUPPLY PROJECT
HYDROGEOLOGIC INVESTIGATION
TECHNICAL MEMORANDUM (TM 2):
MONITORING WELL COMPLETION REPORT AND CEMEX MODEL UPDATE**

**PREPARED FOR
CALIFORNIA AMERICAN WATER**

1.0 INTRODUCTION

1.1 Purpose and Scope

This report provides documentation of the monitoring wells constructed to comply with the Coastal Commission Development Permit issued for the test slant well project and documentation for the refined and recalibrated CEMEX Groundwater Model (CM). Data collected from boreholes drilled to construct the monitoring wells were used to refine the CM, and groundwater level data collected from the test slant well and monitoring wells during both pumping and recovery periods were used for recalibration. The recalibrated CM will be used to evaluate the optimum operational schedule for the proposed full-scale slant well system. The recalibrated CM was also provided to HydroFocus, Inc. as a data/information item for use in their update of the North Marina Groundwater Model (NMGWM).

1.2 Monitoring Well Requirement

Coastal Development Permit #A-3-MRA-14-0050, dated December 8, 2014 and amended October 13, 2015 (see Appendix A), granted California American Water Company (CalAm) permission for development consisting of: the construction, operation, and decommissioning of a test slant well (TSW) at the CEMEX sand mining facility in the City of Marina and beneath Monterey Bay in the County of Monterey. Special Condition 11, “Protection of Nearby Wells”, requires groundwater monitoring of a minimum of four wells on the CEMEX site within 2,000 feet (ft) of the test well and one or more offsite wells to record water and salinity levels (see Appendix A). This report provides comprehensive details and results of the drilling, construction, development, and groundwater testing for the monitoring well clusters constructed to monitor groundwater in accordance with this permit.

GEOSCIENCE prepared technical specifications for the construction and development of four monitoring well clusters to be located on the CEMEX site. The technical specifications were provided in a document entitled “Monterey Peninsula Water Supply Project, Hydrogeologic Investigation Workplan,

Attachment 3, Technical Specifications – Monitoring Wells,” dated August 8, 2014. The on-site monitoring wells were to include a total of twelve (12) monitoring wells – three (3) wells constructed at each of four locations. The on-site monitoring well clusters were designated as MW-1, MW-2, MW-3, and MW-4. Due to space requirements during TSW construction, the MW-2 cluster was not constructed, since the wells were located in the construction footprint of the TSW. However, the nine monitoring wells associated with MW-1, MW-3, and MW-4 meet the requirements of the Coastal Development Permit. In addition, monitoring was conducted on the north CEMEX well for a period of time, until the well collapsed in November 2015. Groundwater level and conductivity data were also collected and reported for the TSW.

Each monitoring well cluster consists of three individual, separately constructed monitoring wells completed at different depth intervals. The naming convention for the monitoring wells in each cluster is as follows: MW-1S, MW-1M, and MW-1D for the shallow, middle, and deep wells, respectively, in monitoring well cluster MW-1. The shallow wells are primarily screened in the Dune Sand Aquifer, the middle wells are screened in the 180-Foot Equivalent (180-FTE) Aquifer or 180-Foot (180-FT) Aquifer, and the deep wells are primarily screened in the 400-Foot (400-FT) Aquifer.

Five additional monitoring well clusters were constructed off-site. These monitoring wells are identified as monitoring wells MW-5, MW-6, MW-7, MW-8, and MW-9 (Figure 1). Similar to the on-site monitoring wells, each cluster consists of three monitoring wells completed at different depth intervals. The naming convention for the off-site monitoring wells in each cluster is consistent with the on-site monitoring wells, with “S”, “M,” and “D” indicating wells screened in the shallow, middle, and deep aquifers, respectively. All monitoring well clusters were constructed between December 2014 and July 2015 to monitor water levels and water quality around the TSW site in Marina, California.

In accordance with Coastal Development Permit requirements (Special Condition 1), the data collected from the monitoring wells are reported weekly to document the response or non-response of the shallow and middle completions of MW-4 to long-term pumping of the TSW. In addition, per the requirements of the Coastal Development Permit, data collected weekly for all monitoring wells are made available to the public via the CalAm website. Monthly reports prepared by the Hydrogeologist Working Group (HWG), presenting a summary of monthly groundwater trends, is also provided to the California Coastal Commission (CCC) for permit compliance.

1.3 Monitoring Well Locations and Construction Information

The monitoring wells are identified as either “on-site” or “off-site” well clusters. On-site refers to monitoring wells located on the CEMEX site, and off-site monitoring wells are located off of the CEMEX site. Prior to mobilizing drilling equipment for well construction, a well permit was obtained from the Monterey County Health Department Environmental Health Bureau. Copies of the well permits are

provided in Appendix B. All monitoring well clusters have three different well completions – one screened in the upper, one in the middle, and one in the deeper aquifer zone, generally corresponding with the Dune Sand Aquifer, the 180-FTE/180-FT Aquifer, and the 400-FT Aquifer (with the exception of MW-5S and MW-6D, as explained in greater detail in subsequent sections).

1.3.1 On-Site Monitoring Wells

The on-site monitoring well cluster locations at the CEMEX site are shown on Figure 1. Table 1-1, below, contains basic monitoring well construction information. Additional information is provided in attached Table 1, and detailed as-built well data are provided in Appendix C. Distances shown between the monitoring wells and the TSW are based on the distance from the TSW wellhead to the monitoring wells. The midpoint of the TSW well screen interval is an additional 400 feet seaward of the wellhead.

Table 1-1. On-Site Monitoring Well Summary

Monitoring Well No.	Location Relative to Test Slant Well	Targeted Aquifer	Approximate Distance from Test Slant Well Wellhead [ft]	Reference Elevation*	Monitoring Well Depth [ft bgs**]	Screen Interval [ft bgs]
MW-1S	West of Test Slant Well Entry Point	Dune Sand	250	30.51	98	55–95
MW-1M		180-FTE		29.86	227.5	115–225
MW-1D		400-Foot		29.68	337	277–327
MW-3S	East of Test Slant Well Entry Point	Dune Sand	410	37.16	92	50–90
MW-3M		180-FTE		37.35	230	105–215
MW-3D		400-Foot		36.93	332.5	285–330
MW-4S	East of Test Slant Well Entry Point	Dune Sand	1,920	41.96	105	60–100
MW-4M		180-FTE		41.99	265.5	130–260
MW-4D		400-Foot		41.95	332	290–330

* Reference elevations in NAVD88

** bgs = below ground surface

1.3.2 Off-Site Monitoring Wells

The off-site monitoring well cluster locations near the CEMEX site are also shown on Figure 1. Table 1-2, below, contains basic monitoring well construction information. Additional information is provided in attached Table 1, and detailed as-built well data are provided in Appendix C. The locations of off-site monitoring wells were selected based on available property (MW-5 and MW-6) and requests by Monterey County Water Resources Agency (MCWRA) (MW-8 and MW-9). The MW-7 monitoring well cluster site was selected by the HWG to provide data on aquifer responses in the area between the TSW and the City of Marina.

Table 1-2. Off-Site Monitoring Well Summary

Monitoring Well No.	Location Relative to Test Slant Well	Aquifer	Approximate Distance from Test Slant Well [ft]	Reference Point Elevation	Monitoring Well Depth [ft bgs]	Screen Interval [ft bgs]
MW-5S(P)*	Southeast of Test Slant Well Entry Point	Perched/Mounded Aquifer**	9,750	80.25	85	43–83
MW-5M		180-FTE		80.48	315	100–310
MW-5D		400-Foot		80.06	439	395–435
MW-6S	Southeast of Test Slant Well Entry Point (Blanco Rd. and Salinas River)	Perched "A"	21,500	35.89	63	30–60
MW-6M		180-FT		35.68	230	150–210
MW-6M(L)***		180-FT (lower portion)		35.82	340	255–325
MW-7S	Northeast of Test Slant Well Entry Point	Dune Sand	5,350	50.64	90	60–80
MW-7M		180-FTE		50.29	223	130–220
MW-7D		400-Foot		50.24	350	295–345
MW-8S	Northeast of Test Slant Well Entry Point	Dune Sand	7,200	19.96	84	40–80
MW-8M		180-FTE		19.99	220	125–215
MW-8D		400-Foot		20.08	360	300–350
MW-9S	Northeast of Test Slant Well Entry Point	Perched "A"	10,700	18.42	113	30–110
MW-9M		180-FT		18.32	227	145–225
MW-9D		400-Foot		18.32	395	353–393

- MW-5S(P) was completed in the uppermost aquifer encountered at that location and represents a perched aquifer above the Dune Sand Aquifer, therefore the (P) has been added to distinguish the monitoring data from other Dune Sand Aquifer wells.
- **The perched/mounded aquifer is discussed in Section 3.2.
- *** MW-6M(L) is determined to have been completed in the lower portion of the 180-FT Aquifer (See Section 3.5.1 for explanation).

2.0 DRILLING, TESTING, AND MONITORING WELL INSTALLATION

2.1 Borehole Drilling and Soil Sampling

The Monterey Peninsula Water Supply Project (MPWSP) monitoring wells were drilled, installed, and developed by Cascade Drilling (Contractor). Using the sonic drilling method, the contractor drilled monitoring wells at the locations shown on Figure 1. Each borehole was drilled using telescoping sizes of drill casing, decreasing with depth. The drill casings consisted of 10 ¾-, 9 ⅞-, and 8-inch diameter flush-threaded sonic drill pipe and a 6-inch diameter core barrel. A carbide and tungsten button casing guide shoe was welded to the bottom (leading section) of the drill string to enable the drill pipe to advance through clay, silt, sand, gravel, and cobbles. The monitoring wells that make up each cluster were drilled on 10-foot centers¹ as separate completions, to ensure that each aquifer was isolated from the others for accurate water level trend determination.

The monitoring wells were drilled in the Dune Sand, 180-FTE/180-FT, and 400-FT Aquifers to depths ranging from approximately 63 to 440 feet below ground surface (ft bgs). Figure 1 depicts the relationship between the shallow, middle, and deep monitoring wells. The deepest borehole at each cluster was drilled first. Continuous and minimally disturbed unconsolidated formation samples were collected in the core barrel as it was carried downward with the bit during the drilling of the boreholes. The core barrel was removed at maximum 10-ft intervals, and the collected core was extruded into plastic sleeves in 2.5-ft to 5-ft sections for sample preservation. Each sleeve was labeled with the client name, borehole designation, and depth interval from which the soil sample was collected. Lithology in the deep boring was logged in the field at every lithologic transition using the Unified Soil Classification System (USCS). Detailed lithologic logs for each borehole are contained in Appendix C. Lithology in the shallow and middle boreholes were logged every 10 ft to verify the conditions previously logged in the deep borehole that was located 10 ft and 20 ft from the other two boreholes. The core collected during drilling was placed into core boxes. The core boxes were removed from each site and stored at the CalAm Water Yard in Pacific Grove, California.

Upon reaching the target depth, geophysical logs were collected from the borehole. The design of the shallow, middle, and deep monitoring wells in each cluster (i.e., depths and lengths of well screens, filter pack, and seal locations) was developed using the lithologic data collected from the core and the geophysical logs. Each monitoring well was constructed within a separate borehole (i.e., one well casing and well screen per borehole). The construction of monitoring wells in separate boreholes ensures that proper separation is obtained between aquifers and that representative groundwater levels and water quality from each aquifer are achieved. Each borehole was drilled to its targeted depth using telescoping

¹ The monitoring wells within each cluster were drilled in a line separated by 10 ft.

sizes of sonic casing and a 6-inch diameter core barrel. As described above, continuous core was collected from all boreholes at each cluster for lithologic inspection and verification by a geohydrologist.

2.2 Geophysical Logging

Upon completion of drilling the deepest borehole at each well site (i.e., well cluster), temporary 4-inch Schedule (Sch) 40 PVC screen was installed to the total depth of the borehole prior to removing the drill string. The temporary 4-inch PVC screen enabled geophysical borehole logging tools to be inserted into the borehole by supporting the borehole walls, thus protecting the logging tools.

The suites of geophysical borehole logs were run by Pacific Surveys of Upland, California on the entire depth of the deep borehole in each cluster, with the exception of MW-3. Geophysical logs had been collected during the previous field investigation in the immediate vicinity of MW-3; therefore, the geophysical logs from previous borehole drillings were used for the design of the MW-3 monitoring wells. Geophysical borehole logging tests included:

- Temperature,
- Fluid Resistivity,
- Dual Induction, and
- Gamma Ray.

Logging took place in the presence of a geohydrologist, and three (3) paper copies of each log were provided to the geohydrologist in the field. Additionally, logs in electronic formats, such as PDF and DXF files, were provided to CalAm and the geohydrologist at the time when logging was performed. Geophysical logs were used in conjunction with lithologic logs to determine the screen interval depth. The geophysical logs for each borehole are contained in Appendix C. Due to caving in the upper portion of MW-7D, an additional drill casing was required to stabilize the borehole. Consequently, the geophysical log for MW-7D does not include the upper 65 ft of the borehole. An additional geophysical log was therefore conducted in the MW-7M borehole to document the upper lithologic units in this area.

2.3 Monitoring Well Construction

Upon completion of geophysical logging, the contractor removed the temporary 4-inch PVC screen and cleaned the borehole to the total depth for monitoring well construction.

2.3.1 Casing and Screen

Each monitoring well was constructed using 4-inch Sch 80 PVC well casing and screen equipped with 0.040 inch slots. Casings were installed to total depth and with screened intervals specified by the geohydrologist based upon review of the formation samples (i.e., core) and the geophysical borehole logs. Well completion diagrams were prepared, identifying screen, filter pack, and seal depths. The “As-Built” completion diagrams of each monitoring well are provided in Appendix C. A summary of screen depths is presented in Table 1.

Monitoring well construction was performed by methods that ensured damage did not occur to the casing and screen during installation. The string of casing and screen was not allowed to rest on the bottom of the borehole prior to filter packing; instead, it was suspended within the sonic drill pipe until the filter packing process began. Centralizers were placed above and below the screened interval to keep the PVC casing centered within the borehole. Each observation well was constructed, and all casings set sufficiently round, plumb, and true so as to enable the insertion of a submersible pump used for well development and testing purposes. All PVC well materials were manufactured using flush threaded connections, conforming to ASTM F480-02.

2.3.2 Filter Pack and Annular Seal

The annular space between the boreholes and the 4-inch diameter casing and screen were filled with CEMEX Lapis Lustre #3 gradation silica sand. The following filter pack gradation was selected and based on the lithology of samples collected during the sonic borehole drilling. The filter pack material consisted of CEMEX Lapis Lustre #3 with the following approximate gradations:

Table 2-1. CEMEX Lapis Lustre #3 Gradation Filter Pack

U.S. Standard Sieve Size	Cumulative % Passing
No. 6	100
No. 8	99
No. 12	59
No. 16	9
No. 20	2
No. 30	1

The filter pack was composed of sound, durable, well-rounded particles of natural sand and fine gravel, free from flat or elongated particles². The filter pack material was washed so that it was free from

² Thin, flat, or elongated particles are particles with a length to width ratio of greater than 3:1.

organic matter, shale, carbonates, mica, silt, clay, or other deleterious materials. The uniformity coefficient³ of the filter pack material was between 2.0 and 2.5.

All filter pack material was delivered to the well site by the driller in 50-lb bags prior to casing and screen installation, allowing for adequate time for inspection, testing, and approval. All materials were protected from contamination until they were installed in the borehole. The geohydrologist examined and approved all filter pack material.

After the assembled casing and screen was centered in the borehole, filter pack was carefully poured from the surface into the annular space inside the 6-inch casing that supports the borehole wall. The filter pack was brought to a level directed by the geohydrologist as the 6-inch drill casing was extracted. The filter pack was placed approximately at least 20 ft above the top of the screen. The as-built diagrams provided in Appendix C show the exact depth intervals of filter pack for each monitoring well.

During placement, the sonic casing was periodically vibrated for a short time to ensure no bridging of the filter pack occurred. The top of the filter pack material was measured frequently to monitor the level of the material in the annular space.

An approximately 3-ft thick layer of fine sand seal, consisting of CEMEX Lapis Lustre #60 fine sand, was placed on top of the filter pack. The purpose of the fine sand layer is to discourage movement of cement poured for the upper seal into the filter pack. After carefully pouring the fine sand into the annulus, a minimum of 30 minutes elapsed between placement and pumping the cement seal, to allow sufficient time for the fine sand to fall through the water column and stabilize on top of the filter pack. The approximate gradation of the fine sand seal is as follows:

Table 2-2. CEMEX Lapis Lustre #60 Mesh Fine Sand

U.S. Standard Sieve Size	Cumulative % Passing
No. 20	100
No. 30	100
No. 40	97
No. 50	40
No. 70	8
No. 100	0.5
Pan	0.0

The upper portion of the monitoring wells were sealed using neat cement consisting of cement and water. The cement mixture was sampled by the geohydrologist for approval prior to being pumped into

³ The uniformity coefficient is defined as the ratio of the D₆₀ size to the D₁₀ size of the material size of the material.

the annular space between the 4-inch casing and the borehole wall from the top of the fine sand layer to approximately 3-ft bgs. A maximum of 2% bentonite was added to the cement mixture to make it more fluid for pumping. The remaining uppermost portion of the annular space was filled with concrete during installation of the well pad and monument cover. Once placed, the annular seal at each monitoring well was allowed to set up undisturbed for a minimum of 24 hours.

2.4 Well Development

Development of each monitoring well consisted of bailing, followed by airlifting the screened interval and then pumping to consolidate and clean the filter pack and near-well zone.

For final development, a stainless steel submersible pump capable of producing a minimum of 40 gallons per minute (gpm) with 150 ft of lift was used. The submersible test pump was installed using 1 ½-inch Sch 80 PVC pipe. The Contractor provided a recently calibrated flow meter (equipped with a totalizer) for accurate measurement of flow and a valve to control the flow rate during development. In addition, a sampling port consisting of a ¾-inch hose bib was installed at an accessible location on the discharge line, to facilitate the collection of water quality samples.

The monitoring wells were pumped continuously at a rate of 30 to 40 gpm for approximately four hours, or as the geohydrologist directed. During pumping, the depth to water, instantaneous discharge rate (gpm), flow meter totalizer, turbidity, pH, oxidation-reduction potential (ORP), dissolved oxygen (DO), specific conductance, temperature, and exact time (hours and minutes) of each reading was recorded at 5-minute intervals. Pumping continued until field water quality stabilized, as indicated by no greater than a 5% difference over three consecutive readings.

2.5 Water Quality Sampling

When field parameters stabilized, the geohydrologist collected water quality samples at the end of the well development period and delivered them to Monterey Bay Analytical Services' (MBAS) laboratory for analysis under standard chain of custody procedures. The laboratory analyses were conducted in accordance with the approved workplan. Water quality results are discussed in Section 4.0.

2.5.1 Monitoring Well Instrumentation

Level transducers and conductivity sensors with on-board data logging were installed in monitoring wells both on-site and away from the CEMEX facility. Level transducers that are installed consist of Solinst® Levelogger® Model 3001, Solinst® Levelogger® LTC Junior, and vented and non-vented in-situ AquaTroll® devices.

A Solinst® Barologger® and in-situ BaroTroll are installed in MW-5M and MW-4S, respectively, to normalize for atmospheric barometric variations. Using the Solinst® and in-situ normalization software, data collected from Barologger® and in-situ transducers is used to normalize groundwater level data collected in the other monitoring wells. The transducers measure groundwater levels as well as temperature, conductivity, and pressure every 5 minutes in MW-4S and MW-4M, and every 15 minutes in all other monitoring wells.

Data from the transducers at each well are downloaded weekly and submitted to CalAm for posting on the publicly accessible CalAm website. In addition, monthly monitoring reports summarizing groundwater level and quality trends are prepared by the HWG for submittal to the CCC.

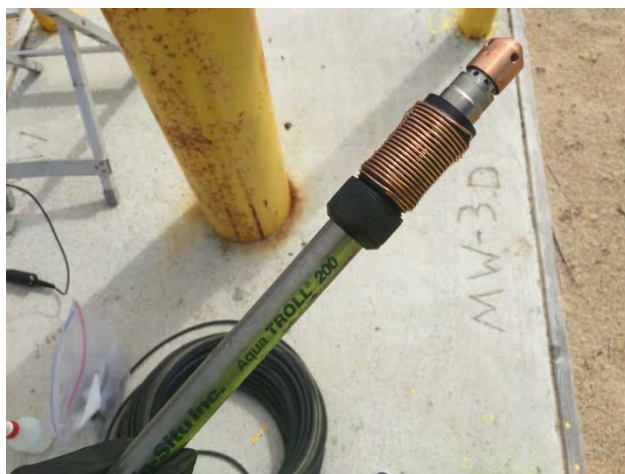


Figure 2-1. Downhole Water Level and Pressure Transducer

2.6 Surface Completion

Each monitoring well was completed with a monument-style protective cover and Class A concrete pad. The concrete well pads measure approximately 5 ft by 5 ft and slope gently away from each well casing and monument. The concrete seal of the well pad extends from the top of the annular seal (at roughly 3 ft bgs) to ground surface. The top of the annular seal was cleaned of debris prior to pouring concrete for the well pad, to ensure that a continuous surface seal was established to prevent the intrusion of surface water.

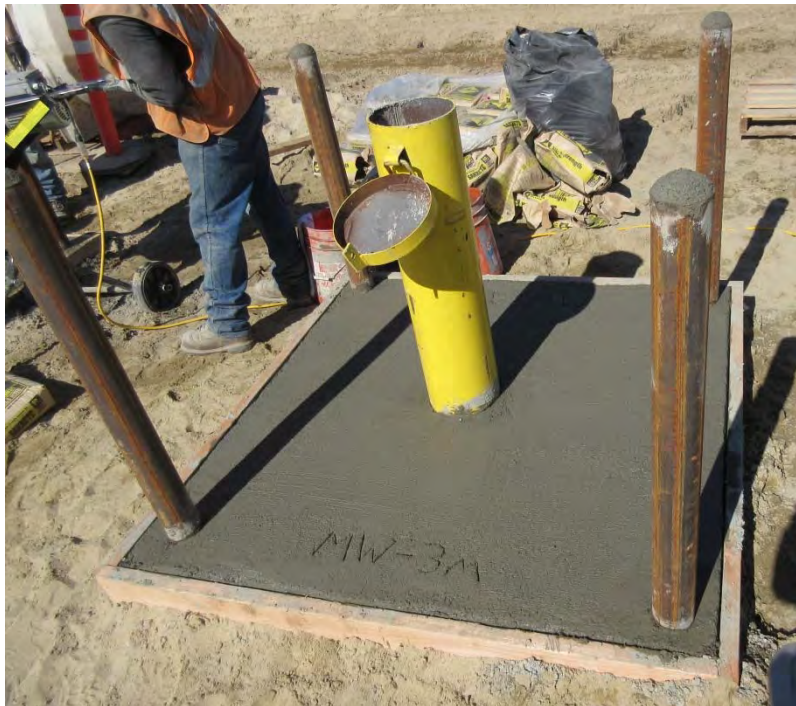


Figure 2-2. Example Surface Completion at MW-3M

Each monitoring well casing is secured by a heavy-duty lock on the locking monument cover. All locks for on-site wells share a key, and all off-site wells share a key. Copies of the keys for on-site and off-site wells were given to CalAm. Additional pictures of the monitoring well cluster completions are shown in Appendix C.

3.0 UPDATED HYDROGEOLOGIC CONCEPTUAL MODEL

The data collected from the monitoring wells were used to refine the hydrogeologic conceptual model developed for the GEOSCIENCE report entitled “Monterey Peninsula Water Supply Project Hydrogeological Investigation – Technical Memorandum (TM1) – Summary of Results Exploratory Boreholes” (2014). Groundwater is present in multiple aquifer systems in the project area. Data from this study validates that water quality is variable in both vertical and areal distribution. Historically, a large proportion of groundwater was extracted for agricultural purposes in the Salinas Valley. The Salinas Valley Groundwater Basin underlies the long, linear Salinas Valley, which extends approximately 100 miles from headwaters in the southeast to Monterey Bay in the northwest at Moss Landing. However, groundwater has also been extracted from the 180-FT, 400-FT, and 900 FT Aquifers beneath the Dune Highland Area located south of the Salinas River (see Figure 2) and more recently from shallow aquifers beneath Fort Ord as a part of remediation activities. The individual aquifer formations described below are represented in cross-sections presented as Figures 3 through 7. Cross-section locations are shown in Figure 2.

Additional cross-sections from those constructed for the 2014 study were constructed using the data collected from the current investigation to further depict the hydrogeologic conditions in the project area. Cross-Section 1A-1A’ (Figure 3) passes west–east through the CEMEX area, MW-1, TSW, MW3, and MW-4, and then proceeds northeast through MW-5. Cross-Section 1B-1B’ (Figure 4) passes through the same CEMEX area and then proceeds southeast from MW-4 through MW-7 and MW-6 into the Salinas Valley proper. Cross-Section 2-2’ (Figure 5) extends from south to north through MW-4, MW-8, and MW-9. Cross-Section 3-3’ (Figure 6) extends south from MW-9 through MW-5, the Monterey Peninsula Landfill, and MW-6. Cross-Section 4-4’ extends from the Fort Ord area in the south to the Salinas Valley proper through MW-8 (Figure 7). Well logs for the wells used in the cross-section are provided in Appendix D.

Figure 8 illustrates the aquifer zones located near the project area. The individual aquifers are discussed by area in the following sections.

3.1 CEMEX

3.1.1 Dune Sand Aquifer

Data collected from drilling of the monitoring wells indicates that the Dune Sand Aquifer is present from ground surface to depths as great as 110 ft bgs near the shoreline in the CEMEX area. Older Dune Sand lies underneath the younger Dune Sand in the CEMEX area (see Figures 3 and 4). Between CEMEX and the landfill, the dune sand appears to thin towards the east and terminate along the north-facing bluff of the Salinas River, which is a geomorphic boundary between the Dune Sand Highland Area and the

Salinas Valley (Figures 3 through 7). The dune sand appears to be in a transitional contact with older fluvial deposits near the landfill. In the Marina Landfill, several water-bearing units isolated by clay units have been identified and named locally during previous investigations conducted for landfill development. These units have been identified as the 80-FT Aquifer, 35-FT Aquifer, and -2-FT Aquifer, named generally for the elevation at which they are encountered at the landfill. These will be discussed briefly in Sections 3.2.2 and 3.4.4 below. Much of the Dune Sand Aquifer is located primarily in the western portion of the area, as shown on Figures 3 through 7. The Dune Sand Aquifer has been described as a fine to medium or fine to coarse-grained quartz sand with occasional silty sand paleosols (soil horizons) distributed vertically in the unit (GEOSCIENCE, 2014). The bottom of the Dune Sand Aquifer is uncertain in the vicinities of MW-6 and MW-7. Only minor groundwater extractions have been made from the shallow aquifer for groundwater remediation in the Fort Ord area.

3.1.2 180-Foot Equivalent (180-FTE) Aquifer

The Terrace Deposits (Qt) are water-bearing materials beneath the Dune Sand Aquifer that make up the 180-FTE Aquifer in the CEMEX area, and beneath the highland dune complex area, south of the Salinas Valley. The Terrace Deposits are approximately 140 ft thick at the coast and reach a thickness of around 220 ft farther inland. They are present beginning at depths of 80 to 90 ft near the coast and are present at depths of about 400 ft bgs, in areas of higher elevation near Fort Ord. The Terrace Deposits that make up the 180-FTE at CEMEX consist of a range of fluvial lithologic units, including thin gravel channels, laminated silt, and very fine sand deposits.

3.2 Marina Landfill Area

Multiple perched aquifers have been identified at the Marina landfill. A number of geotechnical investigations have been conducted at the landfill in the past (Emcon, 1987, 1991; WLF, 2003). Investigations included drilling boreholes and construction of monitoring wells. The highest topographic elevations of the landfill range from about 90 to over 120 ft above mean sea level (amsl) and about 80 to 110 ft above the elevation of the Salinas River, which is present immediately north of the landfill. During the drilling of MW-5, multiple saturated units were penetrated. Springs have been mapped at the landfill at the intersection of the shallow aquifer (35-Foot Aquifer) with the land surface. To be consistent with the approach of completing the other monitoring wells, MW-5S was completed in the uppermost saturated unit. However, the upper saturated unit at the MW-5 location is at a much higher elevation and is not correlative with the shallow completions in the other MPWSP monitoring wells; it appears to be correlative with the 35-Foot Aquifer monitored at the landfill. As a result, the MW-5S monitoring well is now being identified as MW-5S(P), to indicate that the well is monitoring an upper perched/mounded aquifer not correlative with the aquifers monitored by the other shallow “S” completions. The perched/mounded designation is used herein because the shallow aquifer appears to be mounded over a clay unit and perched above the next lower aquifer. Figure 3-1, below, is reproduced

from Figure 3 from the 1991 Emcon hydrogeologic investigation report for the Monterey Class III Landfill. In addition, the WLF Consulting (2003) report further illustrates the relationship of the multiple perched but limited aquifers in the Dune Highland area with the aquifers of the Salinas Valley. A modified cross-section from the 2003 WLF report depicting the multiple perched/mounded aquifers is inset as Figure 3-2.

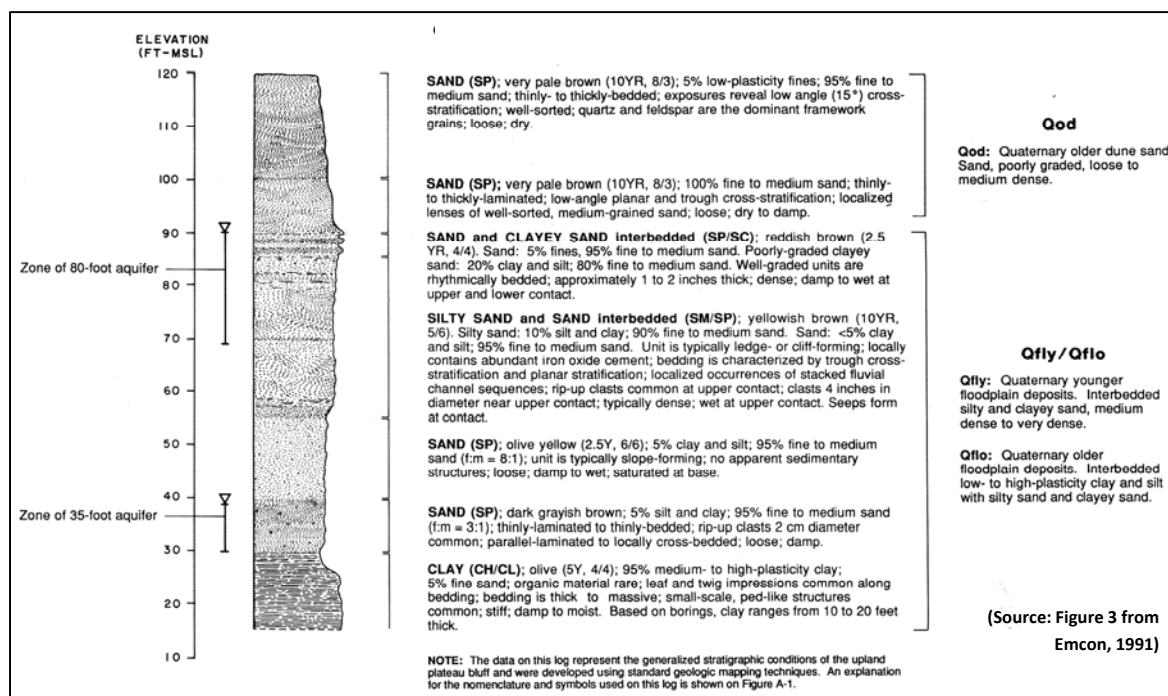


Figure 3-1. Generalized Soil and Groundwater Conditions in the Monterey Peninsula Landfill Upland Plateau

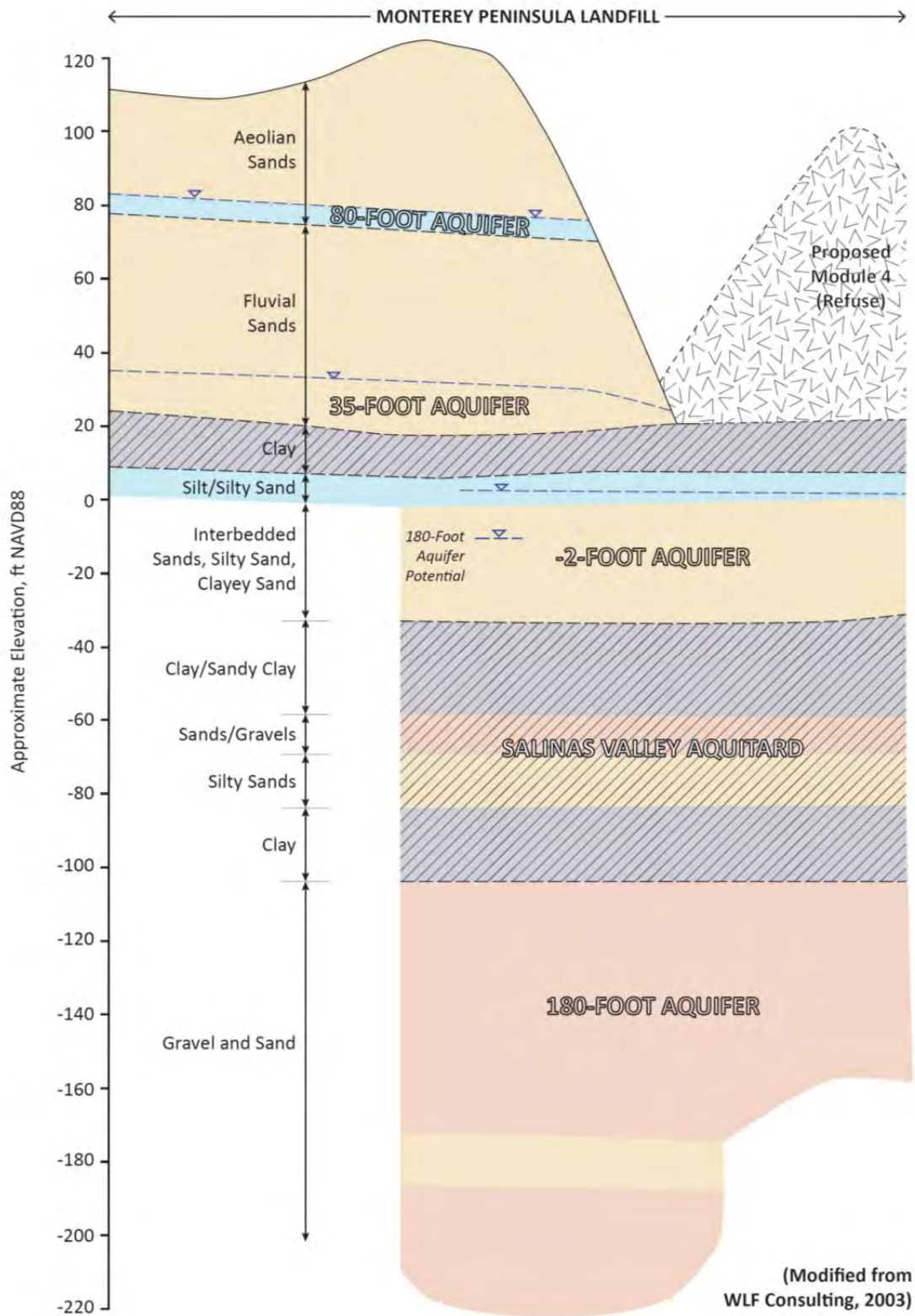


Figure 3-2. Aquifers in the Vicinity of the Monterey Peninsula Landfill

3.2.1 35-Foot Aquifer

There are two (2) aquifer systems that are monitored at the waste management units (WMUs) at the Monterey Peninsula Landfill (RMC Geoscience, 2015). These are the -2-Foot Aquifer and the 35-Foot Aquifer. In addition, a third aquifer, designated as the 80-FT Aquifer, has also been identified at the landfill and is present as the highest of the shallow aquifers at an elevation around 80 ft amsl (Emcon, 1991). The 80-FT Aquifer is very limited in extent and is not present everywhere at the landfill, hence it will not be discussed further.

A water-bearing unit known as the “35-Foot Aquifer” is encountered below the 80-FT Aquifer. It is a perched/mounded groundwater aquifer zone that occurs in a mix of aeolian and fluvial deposits, extends to the south, and underlies the upland terrain. Groundwater in the aquifer generally flows to the northeast and is supplied by rainfall in the uplands area to the south. It is identified on the surface through the presence of seeps and springs along the bluff face around the landfill. Groundwater contours prepared for this study suggest that this aquifer is contiguous with the “A” Aquifer in the Fort Ord area to the south and west of the landfill, but lies above the Dune Sand Aquifer. Thus, the combined Fort Ord “A” Aquifer and landfill 35-Foot Aquifer likely form a shallow perched/mounded aquifer in the highland area, in which groundwater flow directions are controlled by the underlying clay layer (FO-SVA). However, due to a lack of control points in the area between Fort Ord and the landfill, construction of groundwater contours cannot be completed in this area, leaving a gap in groundwater contours between the areas.

3.2.2 Fort Ord Salinas Valley Aquitard (FO-SVA)

What appears to be the distal portion of the Fort Ord Salinas Valley Aquitard (FO-SVA) is present beneath the landfill area (See Figures 2 and 7). This unit is discussed in Section 3.3.2. The approximate extent of the FO-SVA, based on work completed at Ford Ord and from data obtained from this investigation, is shown in Figure 2.

3.2.3 -2-Foot Aquifer

The lower of the two aquifers occurs in an assemblage of silt, sandy silt, and fine-grained sands and is understood to be in direct communication with the Salinas River, which is typically a losing stream into this horizon in this area. Groundwater flow direction and gradients are therefore influenced by the Salinas River and typically flow away from the river. The -2-Foot Aquifer is also locally influenced by surface water recharge associated with the storm water percolation pond at the landfill site (RMC Geoscience, 2015). MW-1, MW-3, MW-4, MW-7, and MW-8 shallow completions (Dune Sand Aquifer) are believed to be screened in water-bearing materials equivalent to this aquifer. This groundwater zone is estimated to be 30 to 40 ft thick and is immediately underlain by the 180-FTE.

3.2.4 180-FTE

The 180-FTE Aquifer is present beneath the landfill and is discussed in Section 3.1.2

3.3 Fort Ord Area

3.3.1 Fort Ord “A” Aquifer (Old Dune Sand)

The first encounter of groundwater within the Fort Ord area is known as the “A” Aquifer. This aquifer is substantially higher in elevation than the Perched “A” Aquifer within the Salinas Valley proper (east of the river). According to Mactec (2005), the “A” monitoring wells were drilled to the top of the Fort Ord-Salinas Valley Aquitard (FO-SVA). Therefore, all “A” wells were designed to monitor the aquifer that rests on the FO-SVA. Fort Ord monitoring well groundwater elevation data suggests that groundwater elevations in the Older Dune Sands (Qod) “A” Aquifer follow a gradient similar to the top of the FO-SVA. Thus, groundwater in the Fort Ord “A” Aquifer is essentially perched or mounded on top of a clay layer (FO-SVA), which controls groundwater flow in the aquifer. The FO-SVA boundary pinches out to the west, roughly 1.5 miles from the shore; to the east, it follows the Salinas River. The southern boundary of the FO-SVA is interpreted to truncate at an erosional contact (Harding ESE, 1999). To the north, the FO-SVA ends approximately between MCWD-12 and MW-7 (see Figure 7). This is evident from the variations in groundwater elevations and lithology within wells of the Fort Ord monitoring network and MPWSP wells, which demonstrate that there is no direct connection or hydraulic continuity with respect to groundwater flow in the Fort Ord “A” Aquifer and Dune Sand Aquifer.

3.3.2 Fort Ord Salinas Valley Aquitard (FO-SVA)

The FO-SVA was identified by investigators working on groundwater clean-up studies in the Fort Ord area. Although identified with the SVA of the Salinas Valley proper, the FO-SVA is stratigraphically lower and chronologically older than the SVA (not to be confused with the fact that the FO-SVA is topographically higher than the SVA). The FO-SVA is the geologic unit underlying older dune sand deposits that crop-out at the surface in the Dune Highland area. The FO-SVA is not present below the dune sand deposits at CEMEX. The approximate extent of the FO-SVA, based on work completed at Fort Ord and from the current work, is shown in Figure 2.

3.3.3 180-FTE

The 180-FTE Aquifer is described in Section 3.1.2 and is present beneath the Fort Ord Salinas Valley Aquitard in the Fort Ord and Marina Landfill areas.

3.4 Salinas Valley

3.4.1 Salinas Valley Perched “A” Aquifer

The recent quaternary Flood Plain Deposits (Qfl) and Basin Deposits (Qb) make up the water-bearing material herein designated as the Salinas Valley Perched “A” Aquifer (Perched “A” Aquifer) in the Salinas Valley. MW-6 and MW-9 are screened in the Perched “A” Aquifer in their shallowest completions. The Perched “A” Aquifer in the Salinas Valley was reported by DWR in a Salinas Valley investigation (1946) as overlying the SVA. According to Kennedy-Jenks (2004), this aquifer typically has low to moderate permeability and ranges up to 75 ft thick. The groundwater is generally of poor quality, degraded by agricultural return waters. The Perched “A” Aquifer consists mainly of sands with silt representing recent river deposition. The Perched “A” Aquifer in the Salinas Valley appears to be hydraulically connected to the -2-Foot Aquifer in the Marina Landfill area and the Dune Sand Aquifer in the CEMEX area.

3.4.2 Salinas Valley Aquitard (SVA)

The SVA is composed of clay and silt with some interbedded sand and is up to 100 ft thick in the project area. The SVA is located underneath the recent alluvial Flood Plain Deposits (Qfl) and Basin Deposits (Qb) of the Salinas Valley. It confines the underlying Valley Fill (Qo) containing the 180-FT Aquifer. The SVA is not present in the CEMEX or Dune Sand Highland areas.

3.4.3 180-Foot Aquifer

The Valley Fill (Qo) in the Salinas Valley consists of water-bearing materials that make up the 180-FT Aquifer beneath the Salinas Valley Aquitard in the Salinas Valley. According to Tinsley (1975), “extrapolation of the stratigraphic position of the 180-Foot Aquifer offshore shows that it lies within the seismic unit which represents the deltaic deposits,” as reported by Greene (1970). The work prepared by Greene suggested approximately 200 ft (60m) to 280 ft (85m) (maximum) thickness of the Holocene deltaic deposits. Tinsley (1975) reported that foraminera⁴ from data collected from the water well cuttings suggested that there is 200 ft (60m) to 250 ft (75m) of Holocene sediments near the coast in the southern Salinas River Valley, which correlates well with the work by Greene. More recent offshore mapping completed by Eittreim et al. (2000) and Grossman et al. (2006) suggests that Quaternary sand and gravel units likely correlative with the 180-FT Aquifer crop out as far west as the top of the submarine canyon.

⁴ Foraminifera (foraminifers or, informally, just forams) are single-celled organisms (amoeboid protists) with shells (plankton).

This unit is composed mainly of sands and gravels with occasional silt or clay lenses that are different than materials that make up the 180-FTE Aquifer in the project area. Despite differences in depositional environments, the 180-FTE and 180-Foot Aquifers are hydraulically connected horizontally.

The base of the Terrace Deposits (180-FTE Aquifer) and the Valley Fill (180-Foot Aquifer) appears to be marked by a transition to thicker clay units (up to 50 ft thick) that include inter-bedded sand and gravel units with occasional cobbles above a distinct “blue” clay layer, which is the 180-FT/400-FT Aquitard.

3.5 Entire Study Area

3.5.1 180/400-Foot Aquitard

A series of clay deposits including a distinctive "blue clay" (i.e., dark bluish gray color) is present starting at depths of approximately 220–330 ft bgs and can be as thick as 120 ft (MW-9). These deposits overlie the 400-Foot Aquifer. Geophysical borehole logs suggest that groundwater in this lower coarse material is different in temperature and salt content than the groundwater above the "blue clay" layer, suggesting that the 180/400-Foot Aquitard is, in general, an effective vertical groundwater flow barrier.

Water levels monitored in monitoring well MW-6D track closely with water levels monitoring in MW-6M. The water level data and lithologic log strongly suggest that the well screen in MW-6D is in fact located in the lower portion of the 180-FT Aquifer. Monitoring Well MW-6D is re-designated herein as MW-6M(L) to indicate that the well screen is perforated in the lower portion of the 180-FT Aquifer.

3.5.2 400-Foot Aquifer

What is interpreted as the Aromas Sand/400-Foot Aquifer was encountered in borings drilled at CEMEX and beneath the Salinas Valley. The unit was penetrated to depths ranging from 265 to 390 ft bgs in the monitoring well borings. The aquifer materials consist of non-indurated to moderately indurated fine to coarse sand with some inter-beds of clay and gravel (see boring logs in Appendix C). The 400-Foot Aquifer has a thickness of approximately 220 to 360 ft, based on previous studies.

3.5.3 Paso Robles Formation

The Paso Robles Formation (QT) was not encountered during this monitoring well drilling process. However, it is included in the cross-sections to illustrate the estimated thickness of the 400-Foot Aquifer. The Paso Robles Formation is a Plio-Pleistocene non-marine unit that lies beneath the 400-Foot Aquifer and contains aquifers of the “deep” aquifer system.

3.6 Summary of Geohydrologic Conditions

Based on data collected during this investigation, the geohydrologic system in the project vicinity appears to exhibit the following characteristics:

- The hydraulic conductivity of the overall system in the project area is highly anisotropic in both the horizontal and vertical directions. This occurs because of interbedded, fine-grained deposits that are present in all boreholes and vary greatly in both the horizontal and vertical dimensions.
- The apparent continuity of measured hydraulic heads is better in lower aquifers than in shallow aquifers. Within the 400-Foot and 180-FT Aquifers, measured groundwater levels can be extrapolated horizontally from one region to another, even though well screens occur at variable depths within an aquifer. Within shallower zones of the geohydrologic system (i.e., 35-FT and -2-FT Aquifers, Salinas Valley “A” Aquifer, “A” Aquifer, and Dune Sand Aquifer), measured groundwater levels are difficult to extrapolate horizontally with any meaning. This is the case because geographically variable recharge at the land surface, as well as variations in anthropogenic activities and geographically variable anisotropic hydraulic conductivity, result in groundwater-level measurements that are highly dependent on well-screen elevations, that is, the position of the specific aquifer in which they are screened. Correspondingly, the horizontal extrapolation of groundwater levels within the shallower zones of the geohydrologic system must be done with caution.
- While these characteristics of the geohydrologic system make predicting hydraulic heads difficult (e.g., hydraulic head differences caused by geographically variable recharge, etc.), they do not represent a particular difficulty for modeling changes in hydraulic head in response to a stress imposed on the system (e.g., TSW pumping). However, without additional data, the representation of the relationship of the shallow aquifers is necessarily conservative, since it is likely that these shallow aquifers (i.e., Dune Sand and the Fort Ord “A” Aquifers) are less hydraulically connected than is currently assumed.

4.0 GROUNDWATER ELEVATIONS AND WATER QUALITY

4.1 Groundwater Elevations

Following development, sampling, and the surface completion of all wells, GEOSCIENCE personnel measured depth to water in all completions. Depth to water was measured with an electric wireline water level indicator. Bestor Engineers, Monterey, CA licensed land surveyors, surveyed the wells for elevation and location. Measured depth to water data were translated to groundwater elevations using the survey data. These elevations are also measured and recorded daily using transducers, as described in Section 2.5.1 of this report. Select hand-measured depth to water readings during TSW pumping and static conditions are shown in Table 1.

Groundwater elevation contours were constructed in order to evaluate groundwater flow and the relationship between aquifers in the CEMEX area. Three data sets were used to construct the groundwater elevation contours:

1. MPWSP Monitoring Network Wells,
2. Monterey Regional Waste Management District (MRWMD) Monterey Peninsula Landfill Monitoring Wells, and
3. Fort Ord Monitoring Network Wells.

Water level measurements from Fall 2015 and Spring 2016 from the three monitoring networks were used to construct the groundwater contours.

4.1.1 Monterey Peninsula Water Supply Project Monitoring Network Wells

As discussed in Section 2.0, MPWSP wells were constructed to monitor groundwater in the three main aquifers near CEMEX. Each monitoring well cluster has a shallow, medium, and deep completion to monitor the Dune Sand, 180-FTE/180-FT, and 400-Foot Aquifers, respectively. However, an analysis of water level and water quality data has shown that MW-5S(P) is completed in the 35-Foot Aquifer, while MW-6M is completed in the Upper 180-FT and MW-6M(L) is completed in the Lower 180-FT Aquifer (refer to Tables 1.1 and 1.2). The construction details of the MPWSP monitoring wells are discussed in Section 2.3 and summarized in Table 1.

4.1.2 Monterey County Pollution Control Agency Monterey Landfill Monitoring Wells

MRWMD landfill wells are divided into wells monitoring the 35-Foot Aquifer and wells monitoring the -2-Foot Aquifer (refer to Section 3.2). The identification of monitoring wells with the specific aquifers being monitored by the landfill provided in the landfill quarterly monitoring reports is based on work

completed by previous geotechnical consultants. The groundwater levels measured in both monitoring well sets appear to be consistent with the aquifer identification.

4.1.3 Fort Ord Monitoring Network Wells

Fort Ord wells utilized for the groundwater contours were taken from the Fort Ord Data Integration System (FODIS). The data were first selected by date interval (Fall 2015 and Spring 2016) and then divided by aquifer designation (i.e., “A”, Upper 180-Foot, Lower 180-Foot, and 400-Foot Aquifers). Water level data for the Fort Ord Monitoring Network wells used to contour groundwater elevations are provided in Appendix E.

The data were separated into four (4) different screen interval zones that best correlated with the depth interval of the respective aquifers, as identified on cross-sections prepared for this study and in previous studies (Harding ESE, 2001; MACTEC, 2005). The “A” Aquifer wells are screened above the FO-SVA. Wells with screened intervals ranging from below zero ft in elevation but above -250 ft elevation were designated as the Upper/Lower 180-Foot Aquifer. Since the hydrostratigraphic units exhibit an apparent northerly and westerly dip, screen intervals in the south will be higher than those to the north. Since the 180-FTE exhibits a westerly and northerly dip, (the top of the 180-FTE exhibits an apparent dip of about 3 degrees in the northerly direction, as shown on Figure 7) wells located at higher elevations in the Fort Ord area will have correspondingly higher elevations of well screens to represent the equivalent portion of the aquifer. Wells screened in the 180-Foot Aquifer were divided into multiple zones by previous investigators. However, only the Upper 180-Foot Aquifer wells (-8 ft to -103 ft elevation) were used for comparison with the MPWSP middle completion wells (see Figure 7 for an illustration of the relationship of well screen elevations in the middle completions).

Lower 180-Foot Aquifer wells were screened from -114 ft to -227 ft elevation, but groundwater elevations appear to be more consistent with 400-Foot Aquifer wells. Screens below -260 ft elevation were considered 400-Foot Aquifer wells within the Fort Ord area.

Fort Ord and landfill wells that likely represented remedial extraction wells (as determined by reported groundwater elevations compared to others in the vicinity), appeared to be anomalous, or which were designated for other aquifers, were omitted from the data sets used to create the contours. Groundwater contours between the Fort Ord wells and the landfill/ MPWSP wells have not been extrapolated, due to insufficient water elevation data (control points) among them.

4.1.4 Groundwater Elevations by Aquifer

4.1.4.1 “A” Aquifer

Of the 705 wells on the FODIS site, 113 wells had documented screen intervals above the elevation of the FO-SVA, so they were considered “A” Aquifer wells. These wells and their groundwater elevations were used to create groundwater contours for the “A” Aquifer in the Fort Ord Area. Figures 9 and 10 show the groundwater elevation contours for the “A” Aquifer in the Ford Ord area for Fall 2015 and Spring 2016, respectively. Groundwater elevations for the “A” Aquifer range from approximately 90 ft to 30 ft in elevation with a groundwater flow direction ranging from north to west-northwest. Although there are no groundwater monitoring wells for control points between Fort Ord and the MRWMD landfill, Fort Ord “A” Aquifer groundwater elevations compare well to those of the landfill 35-Foot Aquifer. In addition, the groundwater elevation in the shallow completion of MPWSP MW-5 S(P) is significantly higher than other MPWSP shallow completions and compares well with the landfill 35-Foot Aquifer and the Fort Ord “A” Aquifer groundwater elevations. Due to a lack of control points between Fort Ord and areas to the north, groundwater contours cannot be constructed between Fort Ord and the landfill.

Figures 9 and 10 also display the groundwater contours of the landfill 35-Foot and MPWSP MW-5S(P) well completion for comparison. The groundwater in this “A” Aquifer generally follows the slope of the FO-SVA, which dips to the north from the highland areas of Fort Ord. Seeps and springs are reported to be present along the bluff faces near the landfill, demonstrating that this aquifer is perched. This suggests that the “A” Aquifer of the Fort Ord area may be hydraulically connected with the 35-Foot Aquifer of the landfill, as evidenced by similar gradients and elevations. As described below, the “A” Aquifer/35-Foot Aquifer appears to be hydraulically disconnected from the coastal Dune Sand Aquifer. A portion of groundwater in the “A” Aquifer may “spill over” the western edge of the FO-SVA, thereby contributing some recharge to the Dune Sand Aquifer. Any such recharge that occurs would be independent (occur regardless) of pumping from the underlying (and hydraulically disconnected) Dune Sand Aquifer.

4.1.4.2 Dune Sand Aquifer

Groundwater elevations from the MPWSP shallow completions (Dune Sand Aquifer) were contoured along with groundwater elevations from the landfill -2-Foot Aquifer monitoring wells. Figures 11 and 12 show the groundwater contours constructed from all shallow MPWSP completions (except for MW-5S(P)) and the -2-Foot Aquifer of the landfill wells for Fall 2015 and Spring 2016, respectively. Water levels from MCWD Dune Sand Aquifer monitoring wells are not included because surveyed elevations are not available for the wells to validate water level elevations.

It is apparent from the groundwater contours that the Fort Ord “A” Aquifer (Figures 9 and 10) is not hydraulically connected to the Dune Sand Aquifer or the landfill -2-Foot Aquifer, since the groundwater elevations, gradients, and flow direction are dissimilar. The Dune Sand Aquifer appears to be hydraulically connected to the Salinas Valley “A” Aquifer of the Salinas Valley proper, based on groundwater elevations in MW-6, MW-8, and MW-9 (see Figure 7). Groundwater flow directions in the Dune Sand Aquifer are complex due to the influence of ocean and river heads; however, Dune Sand Aquifer groundwater flow is indicated to be inland across the CEMEX site.

4.1.4.3 180-FTE/180-Foot Aquifer

The Upper 180-Foot Aquifer in the Fort Ord area is comparable to the middle completions of the MPWSP wells. Groundwater elevations for Fall 2015 and Spring 2016 are presented in Figures 13 and 14, respectively. The dates for MPWSP monitoring well elevation data selected for contour construction were for periods when the TSW was not pumping. The groundwater contour elevations are constructed from wells screened below the FO-SVA in the Fort Ord area and from the MPWSP monitoring wells screened in the 180-FTE Aquifer. Neither the FO-SVA nor the SVA were encountered in MPWSP MW-1, MW-3, MW-4, or MW-7, which are located closer to the coast. The FO-SVA appears to have been penetrated in MW-5, but not in MW-8. The SVA was penetrated in MW-6 and MW-9 (see geologic cross-sections in Figures 3 through 7). The MPWSP middle completions are either screened below the Dune Sand Aquifer or below the FO-SVA and SVA in wells where the aquitard is present. The groundwater elevations in the Fort Ord Upper 180-Foot Aquifer wells and the MPWSP middle completions show similarities in groundwater elevation and gradients. The groundwater surface shows an inland gradient in both data sets. The groundwater gradient is generally easterly at Fort Ord and east-southeasterly in the North Marina area. However, since there is a lack of control points between the Fort Ord area and the MPWSP wells a gap in contours is warranted.

4.1.4.4 400-Foot Aquifer

Groundwater contours for both the Fort Ord 400-Foot Aquifer wells and the MPWSP deep completion wells (400-Foot Aquifer) are shown on Figures 15 and 16 for Fall 2015 and Spring 2016, respectively. Although there is limited data from both the Fort Ord area and the MPWSP wells, the groundwater surface appears to be similar in both the Fort Ord and North Marina area, following the same gradual inland decline away from the shore. The groundwater gradient in Fall 2015 is easterly in the Fort Ord area and northeasterly in the North Marina area. In Spring 2016, groundwater flows southeasterly in the Fort Ord area and easterly in the North Marina area.

4.1.5 Summary of Groundwater Elevations

The Fort Ord/North Marina area is underlain by a shallow perched/mounded aquifer represented by the Fort Ord “A” Aquifer and the Landfill 35-FT Aquifer. The shallow perched/mounded aquifer appears to be hydraulically continuous between the Fort Ord area and the Monterey Peninsula Landfill area, although a significant gap in data exists between the two areas. The groundwater surface appears to be perched/mounded over the FO-SVA and is not present where the FO-SVA is not present (i.e., at the coast and for approximately 1.5 miles inland). This perched/mounded aquifer is also represented by groundwater levels in MW-5S(P). The perched/mounded aquifer in the North Marina area and Fort Ord area is distinct from the Dune Sand Aquifer in the CEMEX area, and at much higher elevations than (and hydraulically disconnected from) the Salinas Valley “A” Aquifer, as identified in the Salinas Valley.

Groundwater in the Dune Sand Aquifer appears to be hydraulically connected to the landfill -2-Foot Aquifer and is at a much lower elevation than the Fort Ord “A” Aquifer wells, landfill 35-Foot Aquifer wells, and MW-5S(P). In addition, the Dune Sand Aquifer appears to be hydraulically connected to the Salinas Valley “A” Aquifer.

Groundwater elevations in the 180-FTE/180-Foot Aquifers and the 400-Foot Aquifer show that groundwater flow is inland, validating the continued presence of historically documented seawater intrusion in these aquifers.

4.2 Water Quality Sampling

Groundwater samples were taken from all three monitoring wells within each cluster following well development. Before a sample could be taken, field parameters had to remain stable through multiple readings. Field parameters were considered stable when recordings taken every five minutes showed three consecutive readings with variations of less than ± 0.1 pH unit, $\pm 3\%$ change in conductivity, ± 10 mV ORP, and $\pm 10\%$ change in DO. Once stabilization had been achieved, turbidity was monitored until it stabilized or dropped below 10 nephelometric turbidity units (NTU). Each completion was pumped to purge at least three times the casing and annular pore space volume.

All samples were submitted to MBAS, in Monterey, California, for analysis of constituents (Appendix F). Some constituents were sub-contracted by MBAS to other certified laboratories. All samples were submitted to the California-certified laboratory under chain of custody protocols within 24 hours of collection (i.e., on the same day, if possible, depending on the actual time of day the sample was collected). Analytical methods used for parameters measured in the field and laboratory, are listed in Table 2. As part of the analytical method, the laboratory was required to run QA/QC per the method requirements and provide a QA/QC report for each analytical method. All laboratory analytical reports

and chain of custody forms are also provided in Appendix F. Laboratory results of samples following well completion are summarized in Table 2.

The Coastal Development Permit requirements for tracking water quality changes are met through the use of downhole conductivity instrumentation that is reported weekly and monthly. Ninety-one (91) weekly reports have been published on the CalAm website since April 22, 2015. Fourteen (14) monthly reports have also been submitted to the CCC since institution of the amended permit in December 2015. The initial water quality sample results obtained immediately after well development for each monitoring well are included in this report. Additional sampling events have occurred since initial sample collection, but are not included as a part of this report. The results of subsequent sampling will be provided in the Test Slant Well Completion and Long-Term Pumping Test Summary Report (TM 3).

4.3 Groundwater Quality – Electrical Conductivity (EC) and Total Dissolved Solids (TDS)

As described in Section 4.2, groundwater samples were collected from each of the monitoring wells after the completion of well development. The groundwater samples were submitted to Monterey Bay Area Laboratories for analysis of general mineral and general physical parameters. The table below summarizes the field specific conductivity (EC) collected immediately prior to sample collection, and the laboratory-measured EC and total dissolved solids (TDS). In general, groundwater is higher in TDS closer to the coast (e.g., all wells in clusters at MW-1, MW-3, and MW-4). In addition, water quality samples from MW-7S, M, and D; MW-8S, M, and D; and MW-9S and M show impacts of historical seawater intrusion. Water quality data from MW-5S(P), M, and D; and MW-6S, M and M(L) may also be reflect seawater intrusion, since the TDS levels are higher than an assumed background level of 500mg/L. The low TDS encountered in MW-9D may represent a density differences in the upper part of the aquifer at this location (seawater wedge concept) or not being proximate to local pumping stresses.

Table 4-1. Field- and Laboratory-Measured EC and TDS

MPWSP WELL	Sample Date	Specific Conductance (EC Lab) [μmhos/cm]	Specific Conductance (EC Field) [μmhos/cm]	Total Dissolved Solids [mg/L]
MW-1S	13-Feb-15	39,090	39,747	26,600
MW-1M	14-Feb-15	43,960	43,788	30,900
MW-1D	14-Feb-15	40,120	40,882	29,100
MW-3S	25-Feb-15	34,180	33,456	23,400
MW-3M	24-Feb-15	41,090	42,340	28,500
MW-3D	21-Feb-15	44,020	41,740	32,600
MW-4S	7-Mar-15	17,050	16,917	11,900
MW-4M	6-Mar-15	26,250	26,779	17,900
MW-4D	19-Feb-15	38,000	5,750	27,500
MW-5S(P)	10-Mar-15	1,752	1,828	1,166
MW-5M	8-Mar-15	1,106	962	663
MW-5D	17-Feb-15	3,775	3,961	2,616
MW-6S	4-Apr-15	989	869	608
MW-6M	4-Apr-15	1,545	1,531	966
MW-6M(L)	2-Apr-15	2,758	2,859	1,840
MW-7S	3-Aug-15	1,768	1,762	1,200
MW-7M	2-Aug-15	5,650	5,507	3,832
MW-7D	9-Aug-15	38,800	39,065	26,700
MW-8S	28-May-15	2,036	2,004	1,260
MW-8M	27-May-15	35,020	35,040	24,000
MW-8D	21-May-15	1,045	1,113	583
MW-9S	30-Jun-15	5,330	5,384	3,204
MW-9M	28-Jun-15	44,090	44,462	29,000
MW-9D	25-Jun-15	624	574	366

5.0 CEMEX MODEL UPDATE

The CM was originally developed in 2015 as part of the Draft Environmental Impact Report (DEIR) for the MPWSP (GEOSCIENCE, 2015). The model is centered at the CEMEX site and surrounding areas with an area of four square miles (see Figure 17). It is a 12-layer model and consists of 540 cells in the i-direction (northeast-to-southwest along rows) and 540 cells in the j-direction (northwest-to-southeast along columns) with a uniform cell size of 20 ft by 20 ft (see Figure 18). The model grid is rotated 16 degrees clockwise from horizontal.

5.1 Conceptual Model

The conceptual model of the CM is based on the geologic and hydrostratigraphic units of the area. The correlation of geologic and hydrostratigraphic units with the CM is summarized in Table 5-1, below.

Table 5-1. Correlation of Hydrostratigraphic Units with CM Layers

Hydrostratigraphic Unit	CM Layer
Benthic Zone	1
Dune Sand Aquifer	2
	3
	4
Salinas Valley Aquitard ¹	5
180-FTE Aquifer	6
	7
	8
180/400-FT Aquitard	9
400-FT Aquifer	10
400/900-FT Aquitard	11
900-FT Aquifer	12

Notes:

180-FTE Aquifer represents “180-Foot Equivalent Aquifer”

¹ The SVA is not present in the CEMEX area and is represented in the CM by a 1-ft thick placeholder (layer 5).

For the purposes of this document, the alluvial materials encountered near the coast (in the CEMEX area) are based solely on analyses of borehole samples (and geophysical borehole logs). To date, no direct geologic correlation can be made between these coastal alluvial deposits and the standard naming convention found further inland (e.g., 180-FT Aquifer, 400-FT Aquifer, SVA, etc.). Therefore, in

this document, the upper materials in the CEMEX site area have been classified as the Dune Sand Aquifer, and the alluvial materials below have been referred to as stratigraphically equivalent and hydraulically connected to the inland 180-FT Aquifer (or 180-FTE Aquifer). Additionally, the current study indicates that the “A” Aquifer at Fort Ord and the MRWMD landfill is higher in elevation than (and hydraulically disconnected from) the Perched “A” Aquifer in the Salinas Valley proper.

5.2 Updated CEMEX Model

The purpose of this 2016 CM update is:

- To refine model layer elevations incorporating the results from the newly constructed monitoring wells (described in previous sections), and
- To refine aquifer parameters (such as hydraulic conductivity and storativity) by recalibrating the model using recent groundwater level data collected from the monitoring wells during the long-term test slant well pumping.

The process of updating and calibrating the CM is discussed in the following sections.

5.2.1 Aquifer Characteristics

5.2.1.1 Model Layer Elevations

Model layers for the CM were updated using the revised cross-sections incorporating monitoring well boring information, as detailed in Section 3.0 (refer to Figures 3 through 7). Revised model layer thicknesses are shown on Figures 19 through 24 for the Dune Sand Aquifer, 180-FTE Aquifer, 180/400-FT Aquitard, 400-FT Aquifer, 400/900-FT Aquitard, and the 900-FT Aquifer. The Salinas Valley Aquitard (SVA), represented as model layer 5, is not present in the CM area. A thickness of one foot was assigned for model layer 5 with a hydraulic conductivity value from the Dune Sand Aquifer. The elevation of each model layer is taken as the top elevation minus the determined thickness; for example, the bottom elevation of model layer 1 is one foot below the surface elevation, the bottom elevation of model layer 2 is the bottom elevation of model layer 1 minus the thickness of model layer 2, and so on.

5.2.1.2 Hydraulic Conductivity

Initial horizontal and vertical hydraulic conductivity values from the existing CM were revised during the recalibration process. During this process, additional hydraulic conductivity zones were defined near Highway 1 for model layers 2 through 8, which were not part of the original model. Calibrated horizontal hydraulic conductivity values for the CM are shown in Figure 25. Originally, the Dune Sand Aquifer

(model layers 2 through 4) and the SVA placeholder (model layer 5) consisted of two hydraulic conductivity zones. The northern zone had a horizontal conductivity value of 340 ft/day, which was recalibrated to be 336.6 ft/day. The southern zone was recalibrated from one zone of 207 ft/day to include four zones with horizontal conductivities of 200 ft/day, 100 ft/day, 750 ft/day, and 500 ft/day from west to east. In addition, while the 180-FTE Aquifer (model layers 6 through 8) originally consisted of only one hydraulic conductivity zone, the recalibrated CM consists of three zones for these model layers. Originally, the horizontal conductivity was 160 ft/day. After the recalibration process, the 180-FTE Aquifer has horizontal hydraulic conductivity values of 50 ft/day, 500 ft/day, and 350 ft/day from west to east.

Calibrated vertical hydraulic conductivity values for the CM are shown in Figure 26. Originally, the Dune Sand Aquifer (model layers 2 through 4) and the SVA placeholder (model layer 5) northern hydraulic conductivity zone had a vertical conductivity value of 0.178 ft/day, which was recalibrated to be 0.16 ft/day. The southern zone was recalibrated from one zone of 10.02 ft/day to include four zones with vertical hydraulic conductivities of 20 ft/day, 10 ft/day, 15 ft/day, and 10 ft/day from west to east. In the 180-FTE Aquifer (model layers 6 through 8), the original hydraulic conductivity zone with a vertical conductivity value of 0.353 ft/day was recalibrated to include three zones with values of 8 ft/day, 10 ft/day, and 7 ft/day from west to east.

5.2.1.3 Storativity

Storativity values for the CM were also refined during the model calibration process. Calibrated storativity values are summarized in Table 5-2, below.

Table 5-2. Calibrated Storativity Values

Layer(s)	Storativity [unitless]
1	0.131
2–4 (Dune Sand Aquifer)	0.131
5	0.004
6–8 (180-FTE Aquifer)	0.004
9	0.0001
10	0.0005
11	0.0001
12	0.001

5.2.2 Model Calibration

5.2.2.1 Calibration Approach

The CM was recalibrated against the measured water level data collected during test slant well pumping for the period from April 22, 2015 through January 13, 2016 with a daily time step using the superposition approach, as recommended by the HWG. The Principle of Superposition states that the solutions to individual parts of a problem can be added to solve composite problems. In using this approach for model calibration, boundary conditions (e.g., constant head) are set to zero so that the effects of individual changes (or stresses) can be evaluated without considering the other concurrent stresses on the system (Reilly et al., 1987). The stress evaluated for the CM recalibration is test slant well pumping. Therefore, in this case, the response measured and calibrated against is the drawdown observed in the nearby monitoring wells. The monitoring wells represent the model calibration target wells and are shown in Figure 27. After establishing the target wells, observed data, and pumping stresses, the CM was recalibrated in a fashion similar to the original calibration (see GEOSCIENCE, 2015) by adjusting model parameters until the model provided a reasonable match between the simulated and measured parameters.

5.2.2.2 Calibration Process

In order to initiate the CM recalibration process, pumping stresses and observed drawdowns had to be established. Initially, the pumping distribution for each model layer (i.e., Dune Sand Aquifer and 180-FTE Aquifer) was estimated from modeled hydraulic conductivity and a time-drawdown analysis from test

slant well pumping. This original distribution was estimated to be 75% from the Dune Sand Aquifer and 25% from the 180-FTE Aquifer⁵. Then, based on the advice of Tim Durbin of the HWG, the Conduit Flow Process (CFP) was applied to validate the pumping percentage by aquifer. The CFP accounts for the percentage of flow from different aquifers during the pumping of wells completed in multiple aquifer zones with varying hydraulic heads. The well provides a conduit for the discharge, and the CFP calculates the percentage of flow from each aquifer zone (e.g., Dune Sand and 180-FTE Aquifers). A schematic of the CFP is provided in Figure 5-1 below.

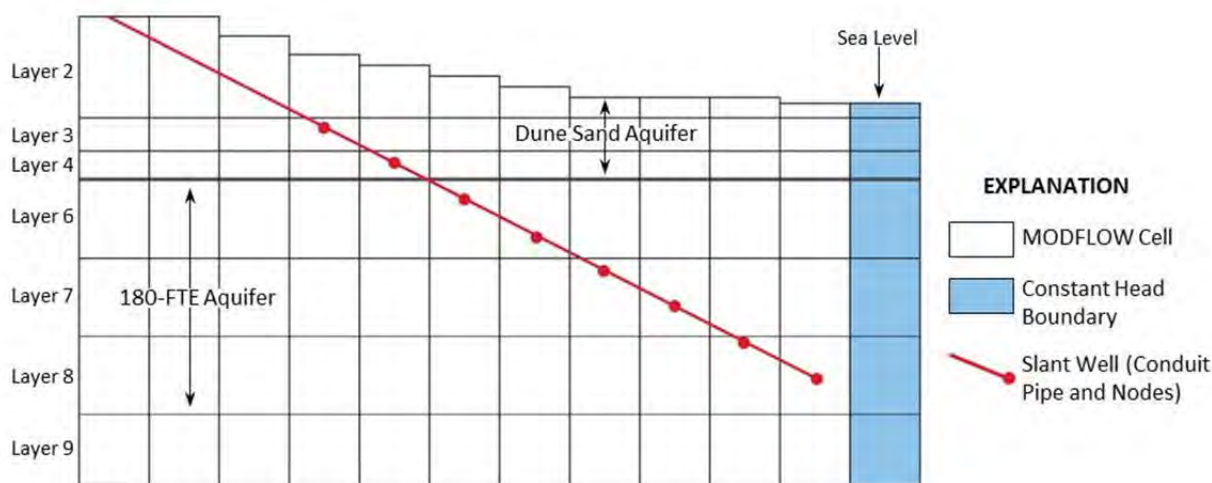


Figure 5-1. Schematic of the Conduit Flow Process (CFP) in MODFLOW (modified from Shoemaker et al., 2007)

Although the model already calculates movement between aquifers with different properties, it assumes vertical leakage only and not vertical leakage plus conduit flow. The CFP accounts for more variables (e.g., screen length, hydraulic conductivity, head, etc.) in the various model layers, therefore providing a better simulation of discharge from the wells for each model layer. Test slant well groundwater pumping during the model calibration period (i.e., 22-Apr-15 through 13-Jan-16) is shown in Figure 28. As shown, the pumping distribution using the CFP is, on average, 64% from the Dune Sand Aquifer and 36% from the 180-FTE Aquifer.

Regional water level trends in each well were calculated using water levels during non-pump test periods. Two regional trends were developed for each well: one for the dry period, from approximately April 2015 through August 2015, showing a declining regional trend, and one for the wetter period, from approximately September 2015 through January 2016, showing an increasing regional trend⁶. The drawdown from test slant well pumping was then calculated for each target monitoring well as the

⁵ This estimation was based on a time-drawdown analysis of data from the 27-Oct-15 to 3-Nov-15 and 3-Apr-15 to 8-Apr-15 TSW pumping tests and applying equations for determining nonsteady flow to multiaquifer wells (Papadopolous, 1966).

⁶ Regional trends for MW-7S decline through approximately September 2015.

difference between the regional water level trends and the observed water level. These drawdown calculations are provided as Figures 29 through 36 for the CM target wells. The CM model was then recalibrated against these data.

5.2.2.3 Calibration Results

The model calibration was based on 1,785 daily drawdown calculations from 268,074 water level measurements in eight wells. Calibration hydrographs for the Dune Sand Aquifer and 180-FTE Aquifer are shown in Figures 37 and 38, respectively. In general, the patterns of the model-calculated drawdowns and drawdowns calculated from observed water level measurements (“observed drawdowns”) are similar, in that the model appears to capture the temporal trends in drawdown in the CM area.

Figure 39 shows a scatterplot of measured versus model-calculated drawdown for all calibration wells. As can be seen, the points are clustered around a diagonal line (representing where measured water levels match model-calculated water levels). In addition, the residual mean is 0.02 ft, and the standard deviation is 0.44 ft. These are all indications that the model provides a good match between measured and model-calculated drawdown.

Relative error is an easy way to check whether the calibration provides a good match between the model-calculated and observed values. It is the standard deviation of the residuals divided by the range in observed values. A residual is the difference between the model-calculated and the observed value. It is common modeling practice is to consider a “good fit” between measured and model-calculated water levels if the relative error is below 10% (Environmental Simulations, Inc., 1999; Spitz and Moreno, 1996). As can be seen in Figure 39, the recalibrated CM does a good job of modeling observed water level changes, with a relative error of 4.0%.

Figure 40 shows a histogram of drawdown residuals of the 1,785 drawdown measurements from the eight target wells. The frequency distribution of water level residuals represents a bell curve, with the majority of the residuals (66.9%) found in the range of plus or minus 0.25 ft. This is another indication of an acceptable model calibration.

Drawdown residuals over time for all calibration wells are plotted in Figure 41. As shown, the residuals tend to oscillate around the zero line, with the most scatter observed during periods of pumping tests (22-Apr-15 through 5-Jun-15 and 27-Oct-15 through 13-Jan-16).

Calibration results of observed versus model-calculated drawdowns for the individual target wells are provided as Figures 42 through 49. Histograms for each target well are provided as Figures 50 through 57, and drawdown residuals over time are shown in Figures 58 through 65. For the individual

target wells, the relative error ranges between 6.8% for MW-1M and 0.6% for MW-7S. This is well within the recommended error of less than 10%.

5.2.3 Model Sensitivity

A sensitivity analysis was performed on the calibrated CM. The purpose of the sensitivity analysis is to assess the model input parameters that have the greatest effects on the model’s simulated results. For this analysis, the model’s sensitivity was evaluated after first increasing the value of model input parameters (relative to the calibrated input value) and then decreasing the value of model input parameters. The following table summarizes the input parameters evaluated during the sensitivity analysis, and it shows how each varies.

Table 5-3. Parameters Analyzed During Sensitivity Analysis

Input Parameter	Sensitivity Analysis
Storativity of the Dune Sand Aquifer	50% and 150% of calibrated value
Storativity of the 180-FTE Aquifer	10% and 150% of calibrated value
Horizontal Hydraulic Conductivity of the Dune Sand Aquifer	50% and 150% of calibrated value
Horizontal Hydraulic Conductivity of the 180-FTE Aquifer	50% and 150% of calibrated value
Vertical Hydraulic Conductivity of the Dune Sand Aquifer	10% and 1,000% of calibrated value
Vertical Hydraulic Conductivity of the 180-FTE Aquifer	10% and 1,000% of calibrated value
Vertical Hydraulic Conductivity of Ocean Floor Sediments	10% and 1,000% of calibrated value

Hydrographs showing the results of the sensitivity run for storativity of the Dune Sand Aquifer are shown in Figures 66a and 66b for the Dune Sand and 180-FTE Aquifer, respectively. Hydrographs for the sensitivity run for storativity of the 180-FTE Aquifer are shown on Figures 67a and 67b for the Dune Sand and 180-FTE Aquifer, respectively. As shown, a reduction in the Dune Sand Aquifer storativity leads to slightly increased model-calculated drawdowns, while an increase in storativity leads to slightly lowered drawdowns, as compared to the calibration run. In general, though, changes in storativity – especially to the 180-FTE Aquifer – do not produce much change in model-calculated drawdown.

Hydrographs showing the results of the sensitivity run for changes in horizontal hydraulic conductivity of the Dune Sand Aquifer are shown in Figures 68a and 68b, while hydrographs for the sensitivity run for changes in horizontal hydraulic conductivity of the 180-FTE Aquifer are shown in Figures 69a and 69b. As shown, changes in the horizontal hydraulic conductivity values of the Dune Sand Aquifer produce the greatest difference in model-calculated drawdowns. A reduction in the horizontal conductivity of either

the Dune Sand or 180-FTE Aquifer leads to increased model-calculated drawdowns, while an increase in horizontal hydraulic conductivity leads to lower drawdowns, as compared to the calibration run. This effect is seen more with increasing proximity to the test slant well; target wells farther away from the coast show less change in drawdowns between the calibration and sensitivity runs.

Sensitivity run results for the change in vertical hydraulic conductivity of the Dune Sand Aquifer are shown as hydrographs in Figures 70a and 70b, and the hydrographs for the change in vertical hydraulic conductivity of the 180-FTE Aquifer are shown in Figures 71a and 71b. Model-calculated drawdowns are affected by changes in the vertical hydraulic conductivity to both the Dune Sand and 180-FTE Aquifers in much the same way as was seen for the horizontal hydraulic conductivity; a reduction in hydraulic conductivity leads to increased model-calculated drawdowns and vice-versa. Also, as with the horizontal hydraulic conductivity, the CM is less sensitive to changes in vertical hydraulic conductivity at wells farther from the test slant well. However, as shown in Figure 71b, both increasing and decreasing the vertical hydraulic conductivity values of the 180-FTE Aquifer lead to higher model-calculated drawdowns in MW-1M⁷. MW-3M is also less sensitive to the vertical hydraulic conductivity changes in the 180-FTE Aquifer, compared to other sensitivity runs on hydraulic conductivity. As shown in Figures 72a and 72b, changes in vertical hydraulic conductivity of the ocean floor sediments have little impact on model-calculated drawdowns.

The purpose of the sensitivity tests was to demonstrate the sensitivity of the model simulations and the uncertainty of model input values. The sensitivity analysis indicates that the model is most sensitive to changes in horizontal hydraulic conductivity of the Dune Sand Aquifer. Figure 73 compares the sum of the squared residuals for the sensitivity runs for selected model parameters, as compared to the calibration run. The greater the difference between the sum of the squared residuals, the more sensitive the parameters to the model residuals (i.e., the difference between model-calculated and measured drawdowns). Input parameter sensitivity is dictated by the magnitude of impact on drawdown residuals resulting from increasing or decreasing the value of the input parameter. Thus, a 50% decrease or increase in horizontal hydraulic conductivity of the Dune Sand Aquifer would have a greater impact on drawdown residuals than similar changes in the other input parameters for the model. Also, as shown, changes in storativity to both the Dune Sand and 180-FTE Aquifers, as well as changes in the vertical hydraulic conductivity of ocean floor sediments, have little effect on the model-calculated drawdowns.

⁷ MW-1 is located near the TSW section screened in the Dune Sand Aquifer. Increasing the vertical hydraulic conductivity of the 180-FTE Aquifer leads to increased flow from the 180-FTE Aquifer to the Dune Sand Aquifer (where pumping is occurring in the vicinity of MW-1). This, in turn, leads to increased drawdown in the 180-FTE Aquifer near the TSW Dune Sand screen (and MW-1M). Decreasing the vertical hydraulic conductivity of the 180-FTE Aquifer leads to decreased flow from the Dune Sand Aquifer to the 180-FTE Aquifer in the vicinity of the TSW section screened in the 180-FTE Aquifer. The increased drawdowns experienced at the TSW 180-FTE screen section extends to the vicinity of the TSW Dune Sand screen, and so shows up in MW-1M as a higher model-calculated drawdown.

6.0 REFERENCES

Anderson, M.P. and Woessner, W.W. 1992. *Applied groundwater modeling – Simulation of flow and advective transport*. New York: Academic Press, 1992.

California American Water (CalAm). Monterey Peninsula Water Supply Project Web Site. <http://www.montereywaterinfo.org/>.

California Department of Water Resources [DWR]. 2003. *California's groundwater*. Bulletin 118, Update 2003. Dated October 1, 2003.

Chin, J.L. and Wolf, S.C. 1988. *Reconnaissance high-resolution geophysical survey of the Monterey Bay, California, inner shelf--implications for sand resources*. USGS Open-File Report: 88-410.

DWR. 1946. *Salinas Basin investigation summary report*. Bulletin No. 52-B.

Eittrheim, S.L., Anima, R.J., Stevenson, A.J. and Wong, F.L. 2000. "Seafloor rocks and sediments of the continental shelf From Monterey Bay to Point Sur, California," USGS Miscellaneous Field Studies Map 2345.

Emcon. 1991. *Monterey Regional Waste Management District, Marina class III landfill geologic and hydrogeologic study*. Monterey County, California.

Fort Ord Data Integration System (FODIS). Fodis.net.

Fugro West, Inc. 1996. *Marina Coast Water District seawater desalination project: Initiation of inland groundwater monitoring*.

GEOSCIENCE Support Services, Inc. [GEOSCIENCE]. 2013a. *Monterey Peninsula Water Supply Project – Hydrogeologic investigation work plan – Attachment 1: Technical specifications exploratory boreholes*. Prepared for California American Water and RBF Consulting, dated August 27, 2013.

GEOSCIENCE, 2013b. *Monterey Peninsula Water Supply Project – Hydrogeologic investigation work plan*. Prepared for California American Water/RBF Consulting, December 18, 2013.

GEOSCIENCE, 2014a. *Monterey Peninsula Water Supply Project hydrogeologic investigation – Technical memorandum 1 (TM 1) summary of results – Exploratory boreholes*. Prepared for California American Water and RBF Consulting. Dated July 8, 2014.

GEOSCIENCE, 2014b. *Monterey Peninsula Water Supply Project – Hydrogeologic investigation work plan – Attachment 2: Technical specifications test slant well (volumes I and II)*. Prepared for California American Water and RBF Consulting, Draft dated June 27, 2014.

- GEOSCIENCE, 2014c. *Monterey Peninsula Water Supply Project – Hydrogeologic investigation work plan – Attachment 3: Technical specifications monitoring wells*. Prepared for California American Water and RBF Consulting, Draft dated August 8, 2014.
- GEOSCIENCE. 2015. *Monterey Peninsula Water Supply Project – Groundwater modeling and analysis*. Prepared for California American Water and Environmental Science Associates (ESA), Draft dated April 17, 2015.
- Greene, G.H. 1970. *Geology of southern Monterey Bay and its relationship to ground water basin and sea water intrusion*. U.S. Geologic Survey Open-File Report.
- Grossman, E.E., Eittreim, S.L., Field, M.E. and F.L. Wong. 2006. “Shallow stratigraphy and sedimentation history during high-frequency sea-level changes on the central California shelf” in *Continental Shelf Research*.
- Guo, W. and Langevin, C.D. 2002. *User’s guide to SEAWAT: A computer program for simulation of three-dimensional variable-density ground-water flow*. U.S. Geological Survey Techniques of Water-Resources Investigations 6-A7.
- Harbaugh, A.W., Banta, E.R., Hill, M.C. and M.G. McDonald. 2000. *MODFLOW-2000, the U.S. Geological Survey modular ground-water model—User guide to modularization concepts and the Ground-Water Flow Process*. USGS Open-File Report 00-92. Reston, Virginia: U.S. Geological Survey.
- Harding Lawson Associates [HLA]. 1999. *Draft final OU 2 plume delineation investigation report, Fort Ord, California*. Prepared for USACE.
- HLA. 2001. *Final report: Hydrogeologic investigation of the Salinas Valley Basin in the vicinity of Fort Ord and Marina, Salinas Valley, California*.
- Harding ESE. 2001. *OU2 plume delineation investigation report, phase II – Fort Ord, California*.
- Luhdorff and Scalmanini, Consulting Engineers [LSCE]. 2015. *Hydrologic modeling of the Monterey Peninsula Water Supply Project using the Salinas Valley integrated ground and surface water model*. Prepared for GEOSCIENCE, Updated Draft (Version 2), dated March 2015.
- MACTEC. 2005. *Draft – operable unit carbon tetrachloride plume groundwater remedial investigation/feasibility study, former Fort Ord, California. Volume 1 – Remedial Investigation*
- National Oceanic and Atmospheric Administration [NOAA]. 2016. *Observed tides/water levels at 9413450, Monterey CA*. Accessed at: tidesandcurrents.noaa.gov/waterlevels.html?id=9413450

Papadopoulos, I.S. 1966. Nonsteady flow to multiaquifer wells. *Journal of Geophysical Research*, vol. 71, no. 20, pp. 4791–4797.

Reilly, T.E., Franke, O.L. and Bennett, G.D. 1987. “The principle of superposition and its application in ground-water hydraulics.” In *Techniques of water-resources investigations of the United States Geological Survey, Book 3: Applications of hydraulics*. United States Government Printing Office, Washington.

RMC Geoscience, Inc. 2015. *Monterey Peninsula landfill second 2015 semiannual water quality monitoring report. April 2015–September 2015*. Prepared for Monterey Regional Waste Management District, Draft dated November, 2015.

Shoemaker, W.B., Kuniansky, E.L., Birk, S., Bauer, S. and Swain, E.D. 2008. *Documentation of a conduit flow process (CFP) for MODFLOW-2005*. U.S. Geological Survey Techniques and Methods, Book 6, Chapter A24. A product of the Ground-Water Resources Program.

Tinsley, John III. 1975. *Quaternary geology of the northern Salinas Valley, Monterey County, California*.

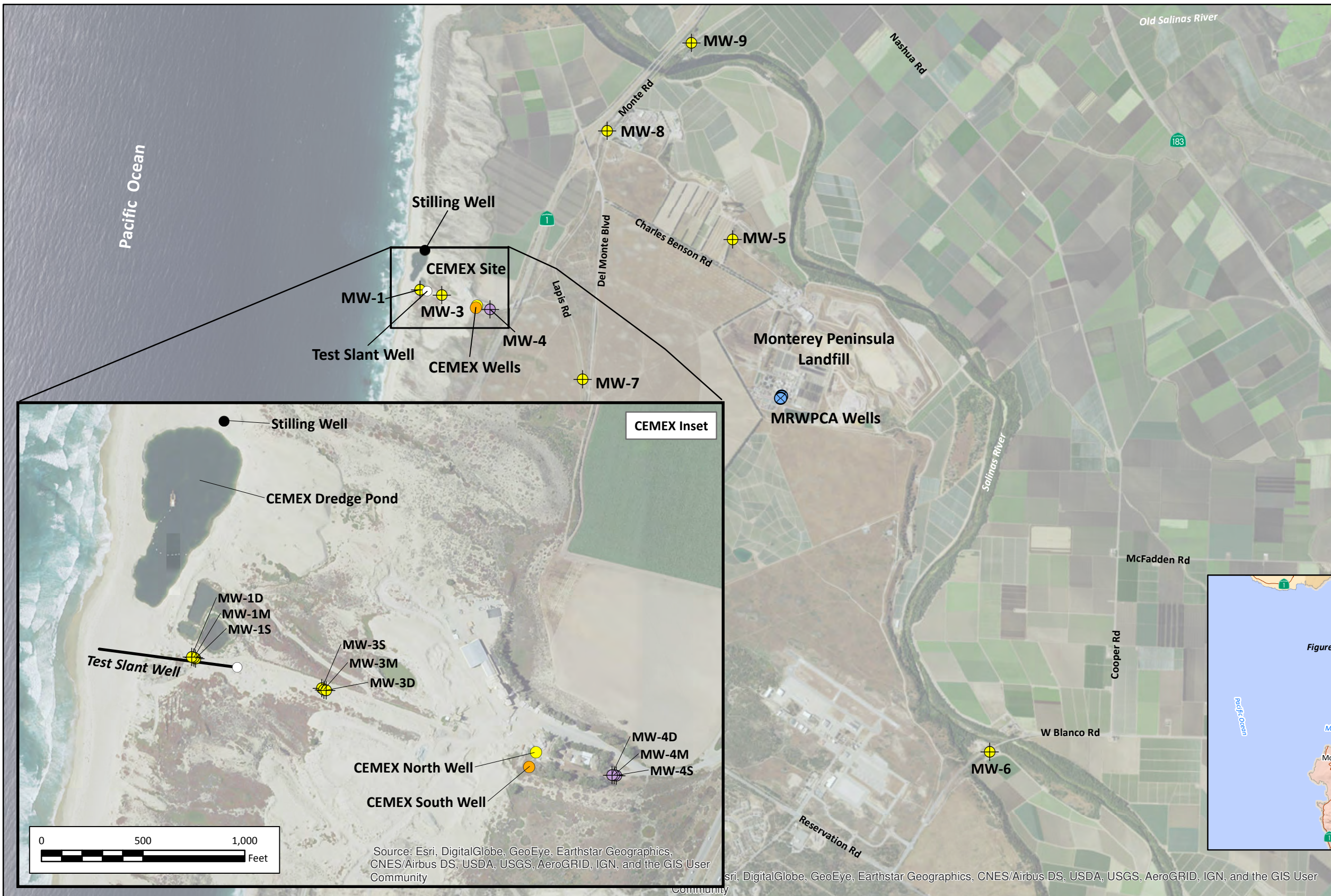
Todd, D.K. and Mays, L.W., 2005. *Groundwater Hydrology*. Third Edition. John Wiley & Sons, Inc. 636 p.

WLF Consulting [WLF]. 2003. *Optional demonstration and amended ROWD*. Monterey Peninsula Landfill, Marina, California.

Zheng, C. and Wang, P. 1998. *MT3DMS, A modular three-dimensional multispecies transport model for simulation of advection, dispersion and chemical reactions of contaminants in groundwater systems*. Vicksburg, Miss., Waterways Experiment Station, U.S. Army Corps of Engineers.

FIGURES

**TEST SLANT WELL
AND MONITORING
WELL LOCATIONS**



EXPLANATION

- Monitoring Well Cluster
- Compliance Monitoring Well Cluster
- Inactive Production Well
- CEMEX Well - Inactive (Monitored)
- CEMEX Well - Active (Not Monitored)
- Stilling Well
- Test Slant Well

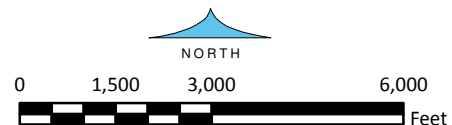
Source: Esri, DigitalGlobe, GeoEye, Earthstar Geographics, CNES/Airbus DS, USDA, USGS, AeroGRID, IGN, and the GIS User Community

Esri, DigitalGlobe, GeoEye, Earthstar Geographics, CNES/Airbus DS, USDA, USGS, AeroGRID, IGN, and the GIS User Community

8-Feb-17

Prepared by: DB. Map Projection: State Plane 1983, Zone IV.

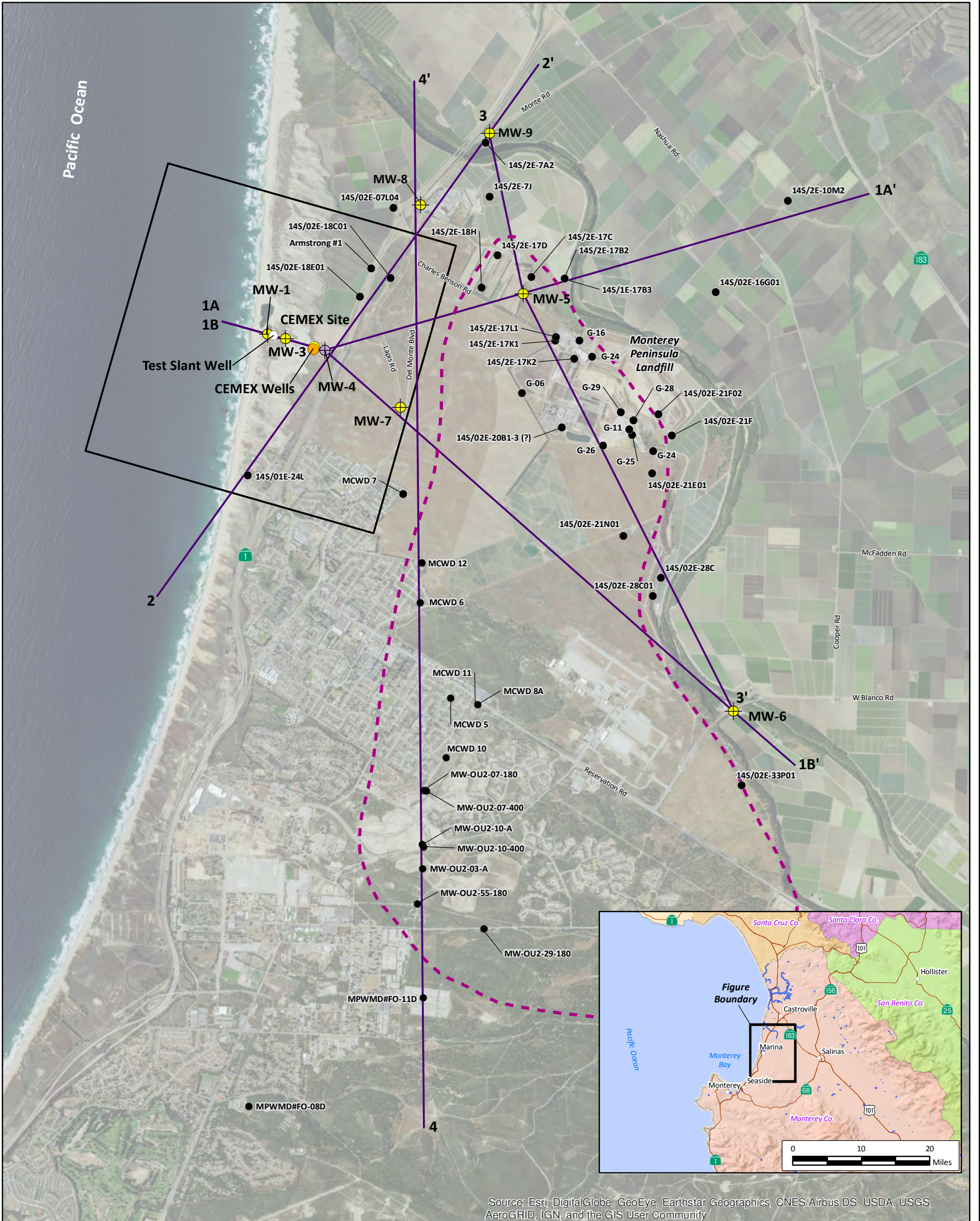
© 2017, GEOSCIENCE Support Services, Inc. All rights reserved.



GEOSCIENCE

GEOSCIENCE Support Services, Inc.
P.O. Box 220, Claremont, CA 91711
Tel: (909) 451-6650 Fax: (909) 451-6638
www.gssiwater.com

Figure 1



W:\GIS\proj\mowsp_cal_am\cal-am_CEMEX_model\Model_Calibration\10_Fig_2_xsec_well_locs_port_2-17.mxd

Source: Esri, DigitalGlobe, GeoEye, Earthstar Geographics, CNES/Airbus DS, USDA, USGS, AeroGRID, IGN, and the GIS User Community

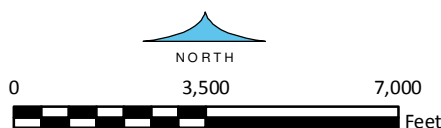
EXPLANATION

- CEMEX Model Boundary
- Cross-Section Location
- Fort Ord Salinas Valley Aquitard (FO-SVA) (GEOSCIENCE, 2016)

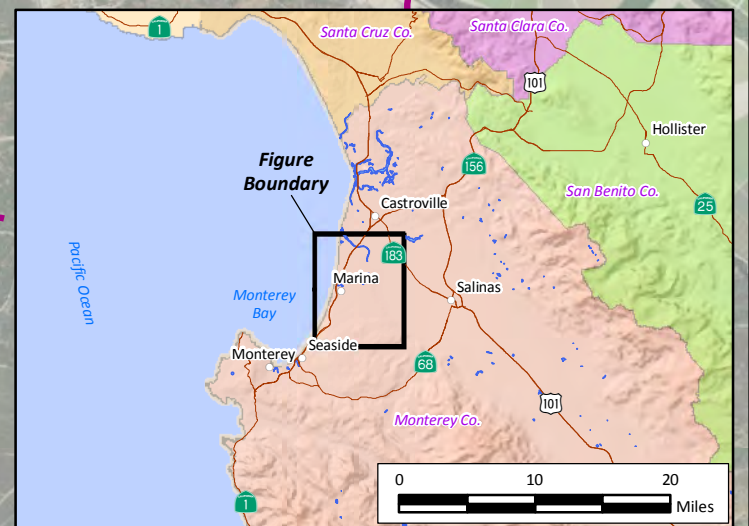
- Monitoring Well Cluster
- Compliance Monitoring Well Cluster
- CEMEX Well - Inactive (Monitored)
- CEMEX Well - Active (Not Monitored)

- Test Slant Well
- Other Well Used in Cross-Sections

8-Feb-17
Prepared by: DB. Map Projection: State Plane 1983, Zone IV.
© 2017, GEOSCIENCE Support Services, Inc. All rights reserved.

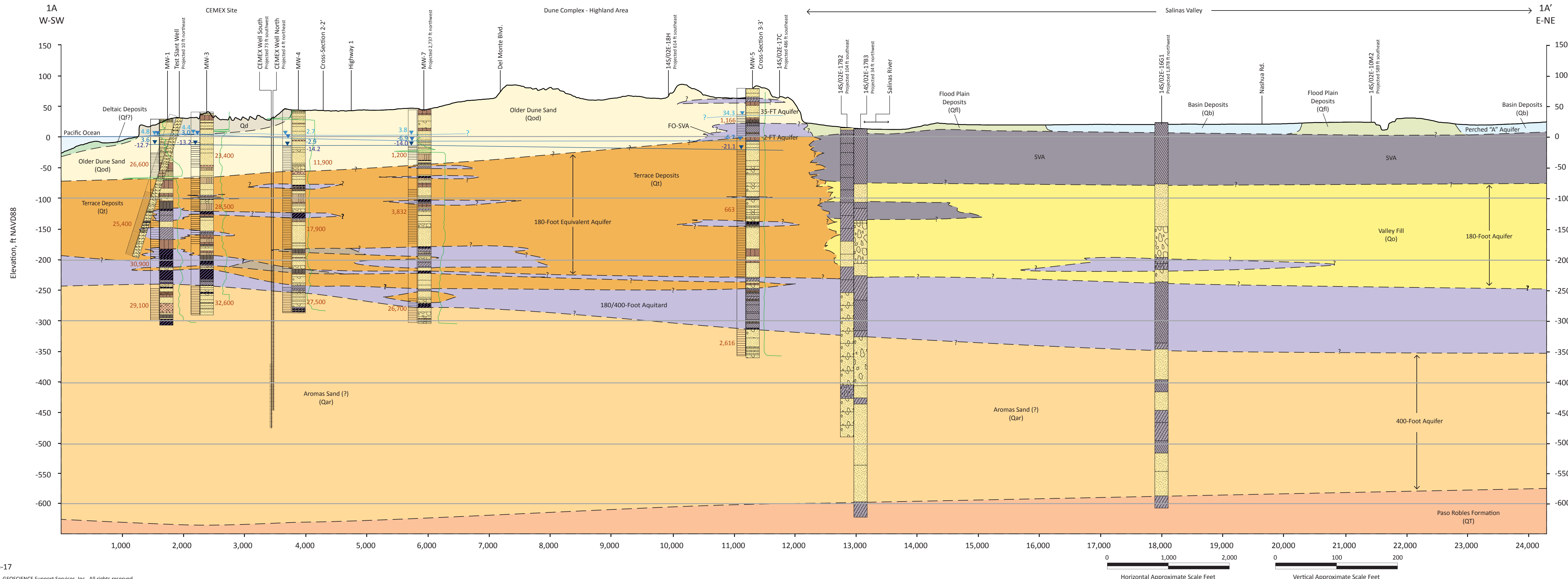


**REGIONAL LOCATION MAP
SHOWING WELL AND
CROSS-SECTION
LOCATIONS**



GEOSCIENCE
GEOSCIENCE Support Services, Inc.
P.O. Box 220, Claremont, CA 91711
Tel: (909) 451-6650 Fax: (909) 451-6638
www.gssiwater.com

Figure 2



GEOLOGIC CROSS-SECTION 1A-1A'

Explanation

Holocene	Qf	Qb
	Qd	
Pleistocene	Qo	Qod
	Qt	
	Qf	
	Qar	
Pliocene	QT	

SVA Clay Layer
 Clay Layer
 —?— Geologic Contact (approximate)

Wells

MPWSP Monitoring Well Screened Interval
 Screened Interval from DWR Well Log
 Well Lithology
 Conductivity Induction Log Deep (CILD) [mmho/m]

Groundwater Elevation, ft NAVD88 (10-Sep-15)

5.1 Shallow Completion
 4.0 Middle Completion
 -9.0 Deep Completion

34,500 Water Quality (TDS) Measurement, mg/L (February, March, and August 2015)

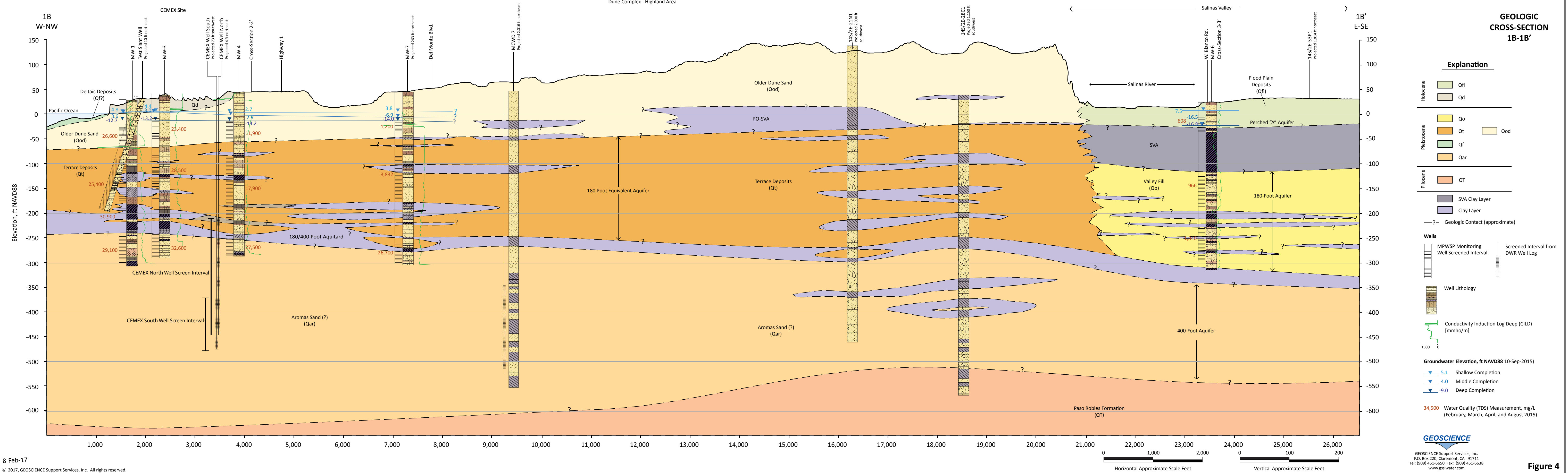
8-Feb-17

© 2017, GEOSCIENCE Support Services, Inc. All rights reserved.

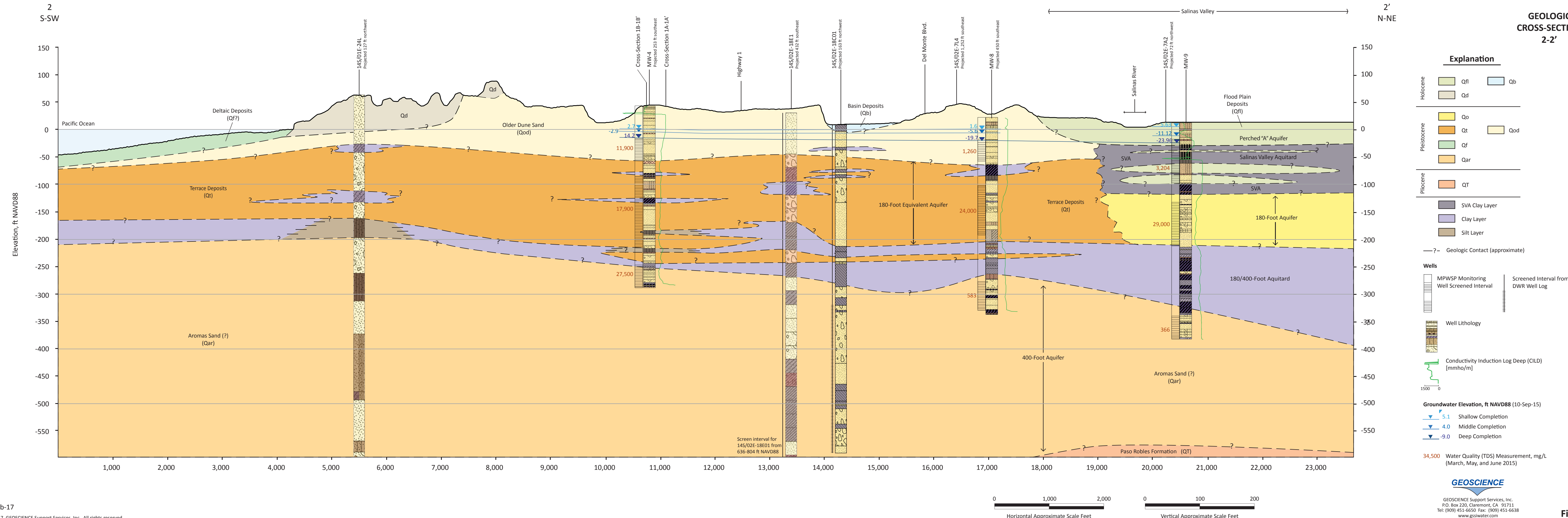
X:\Projects\MONTEREY AREA DESAL STUDIES\01a) Test Slant Well Project\01) Monitoring Wells\4) TM Monitoring Well Completion\03) Final TM Feb_17\Figures

GEOSCIENCE
 GEOSCIENCE Support Services, Inc.
 P.O. Box 220, Claremont, CA 91711
 Tel: (909) 451-6650 Fax: (909) 451-6638
 www.gsiwater.com

Figure 3



GEOLOGIC CROSS-SECTION 2-2'



Explanation

Holocene	Qf	Qb
	Qd	
Pleistocene	Qo	Qod
	Qt	
	Qf	
	Qar	
Pliocene	QT	

SVA Clay Layer
 Clay Layer
 Silt Layer

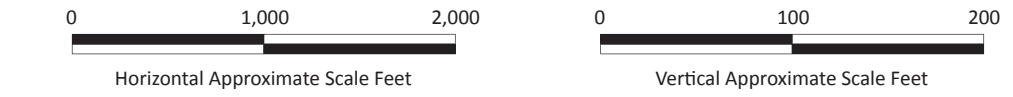
?- Geologic Contact (approximate)

Wells

MPWSP Monitoring Well Screened Interval
 Screened Interval from DWR Well Log
 Well Lithology
 Conductivity Induction Log Deep (CIL) [mmho/m]

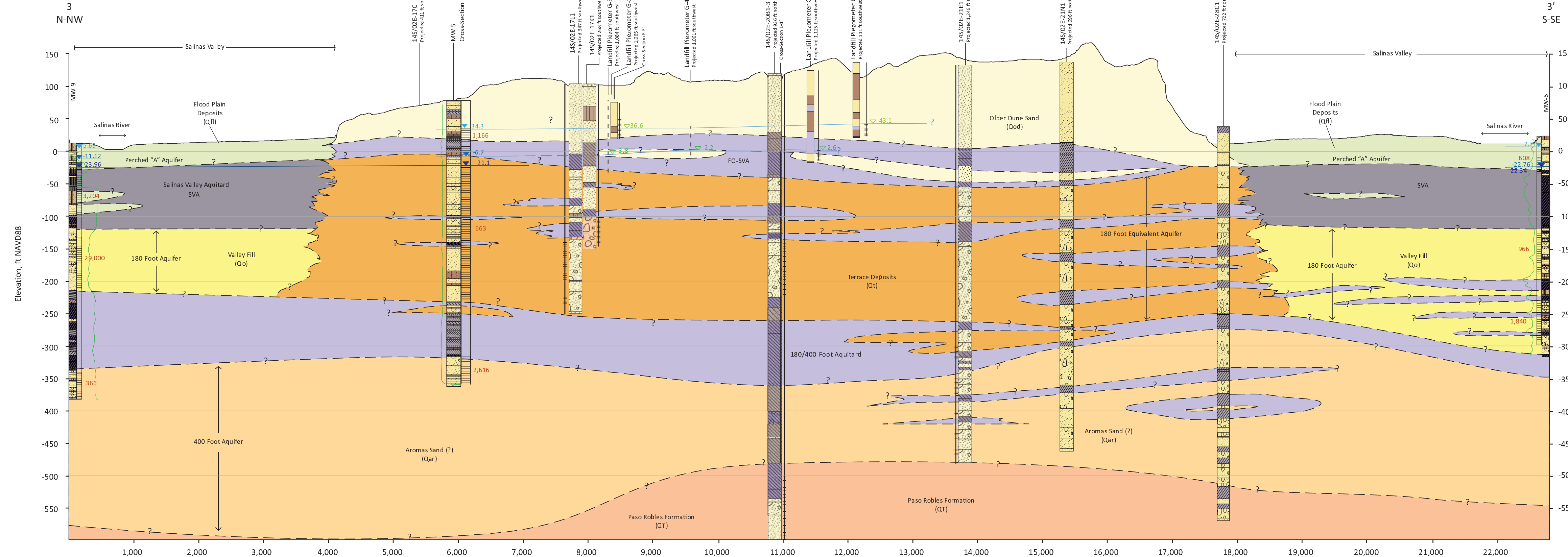
Groundwater Elevation, ft NAVD88 (10-Sep-15)
 5.1 Shallow Completion
 4.0 Middle Completion
 -9.0 Deep Completion

34,500 Water Quality (TDS) Measurement, mg/L (March, May, and June 2015)



X:\Projects\MONTEREY AREA DESAL STUDIES\01a) Test Slant Well Project\01) Monitoring Wells\4) TM Monitoring Well Completion\03) Final TM Feb_17\Figures

GEOLOGIC CROSS-SECTION 3-3'



Explanation

Holocene	Qfl	Qb
	Qd	
Pleistocene	Qo	Qod
	Qt	
	Qf	
	Qar	
Pliocene	QT	
	SVA Clay Layer	
	Clay Layer	

--- Geologic Contact (approximate)

Wells

- MPWSP Monitoring Well Screened Interval
- Well Lithology
- Conductivity Induction Log Deep (CILD) [mmho/m]
- Screened Interval from DWR Well Log or Monitoring Reports
- Total Length of Landfill Wells with Unknown Screen Intervals

Groundwater Elevation, ft NAVD88 (10-Sep-2015)

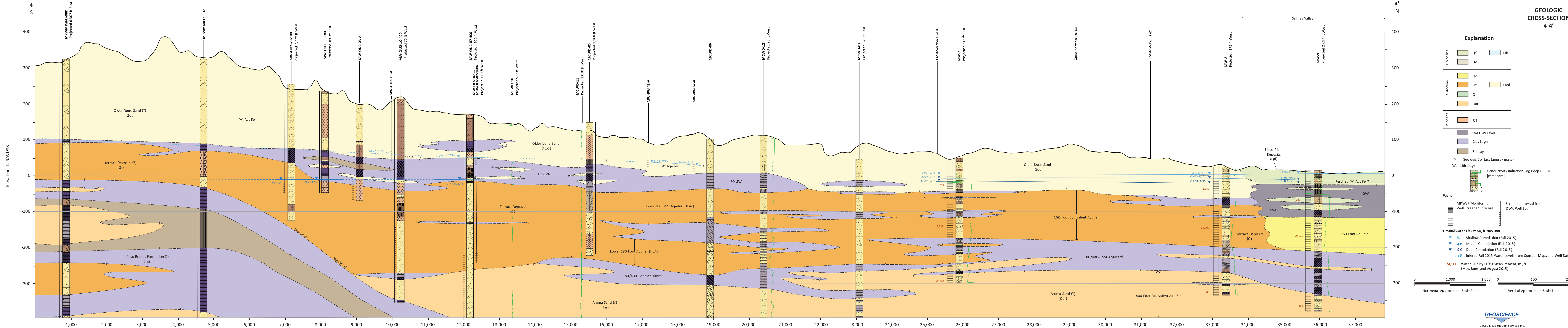
- 5.1 Shallow Completion
- 4.0 Middle Completion
- 9.0 Deep Completion
- 36.6 Landfill Monitoring Well Screened in 35 ft Aquifer
- 7.5 Landfill Monitoring Well Screened in -2 ft Aquifer

Note: Landfill Monitoring Well construction details unavailable

34,500 Water Quality (TDS) Measurement, mg/L (February, March, April and June 2015)



GEOLOGIC CROSS-SECTION 4-4'



Explanation

Hydrocene

- Qf
- Qb
- Qd

Pleistocene

- Qo
- Qt
- Qf
- Qar
- Qod

Pliocene

- QT

Well Lithology

- SVA Clay Layer
- Clay Layer
- Silt Layer

Well Lithology

- Geologic Contact (approximate)
- Conductivity Induction Log Deep (CILd) [mmho/m]

Wells

- MPWSP Monitoring Well Screened Interval
- Screened Interval from DWR Well Log

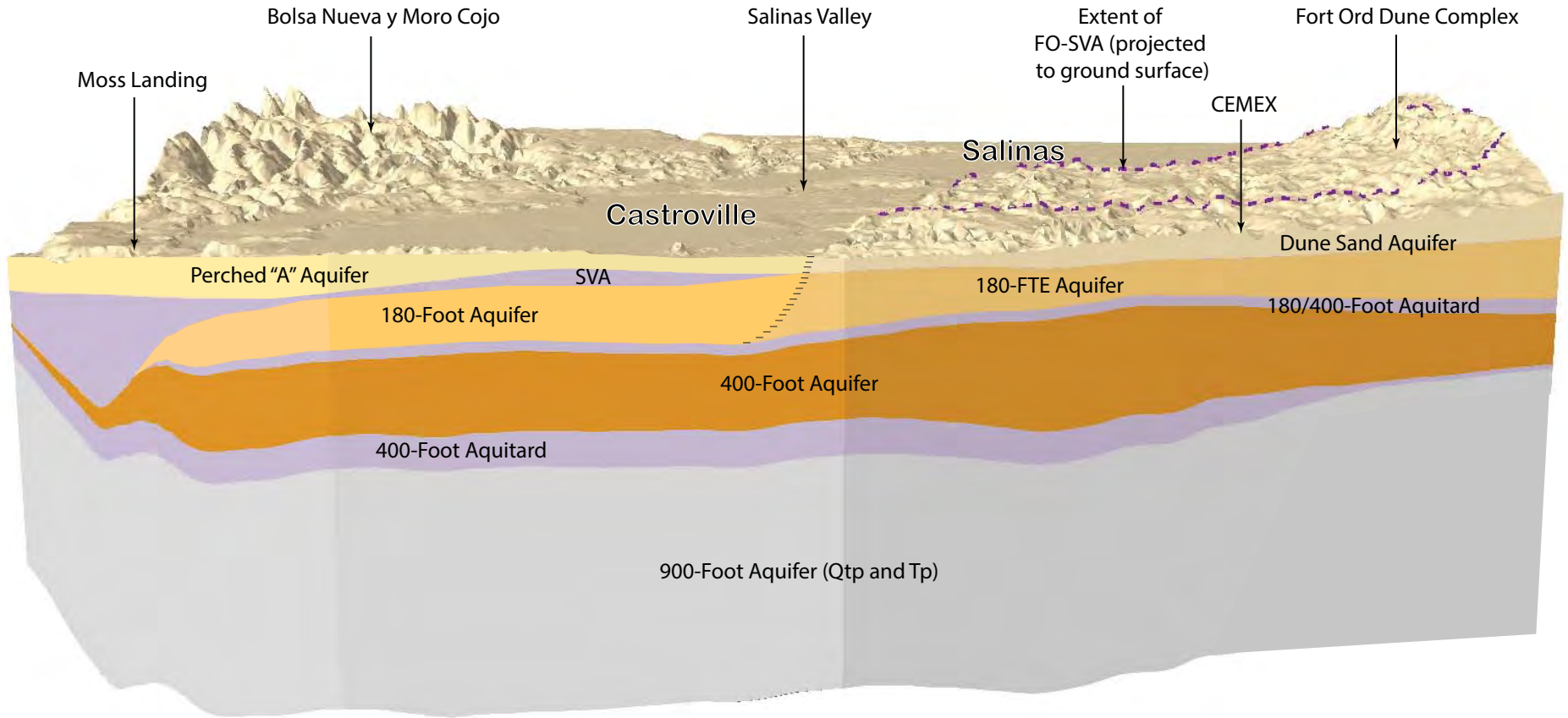
Groundwater Elevation, ft NAVD88

- 5.1 Shallow Completion (Fall-2015)
- 4.0 Middle Completion (Fall-2015)
- 9.0 Deep Completion (Fall-2015)
- 3.75 Inferred Fall 2015 Water Levels from Contour Maps and Well Data.
- 34,500 Water Quality (TDS) Measurement, mg/L (May, June, and August 2015)

Scale

- Horizontal Approximate Scale Feet: 0, 1,000, 2,000
- Vertical Approximate Scale Feet: 0, 100, 200

Figure 7



Note: 10x Vertical Exaggeration

8-Feb-17

© 2017, GEOSCIENCE Support Services, Inc. All rights reserved.

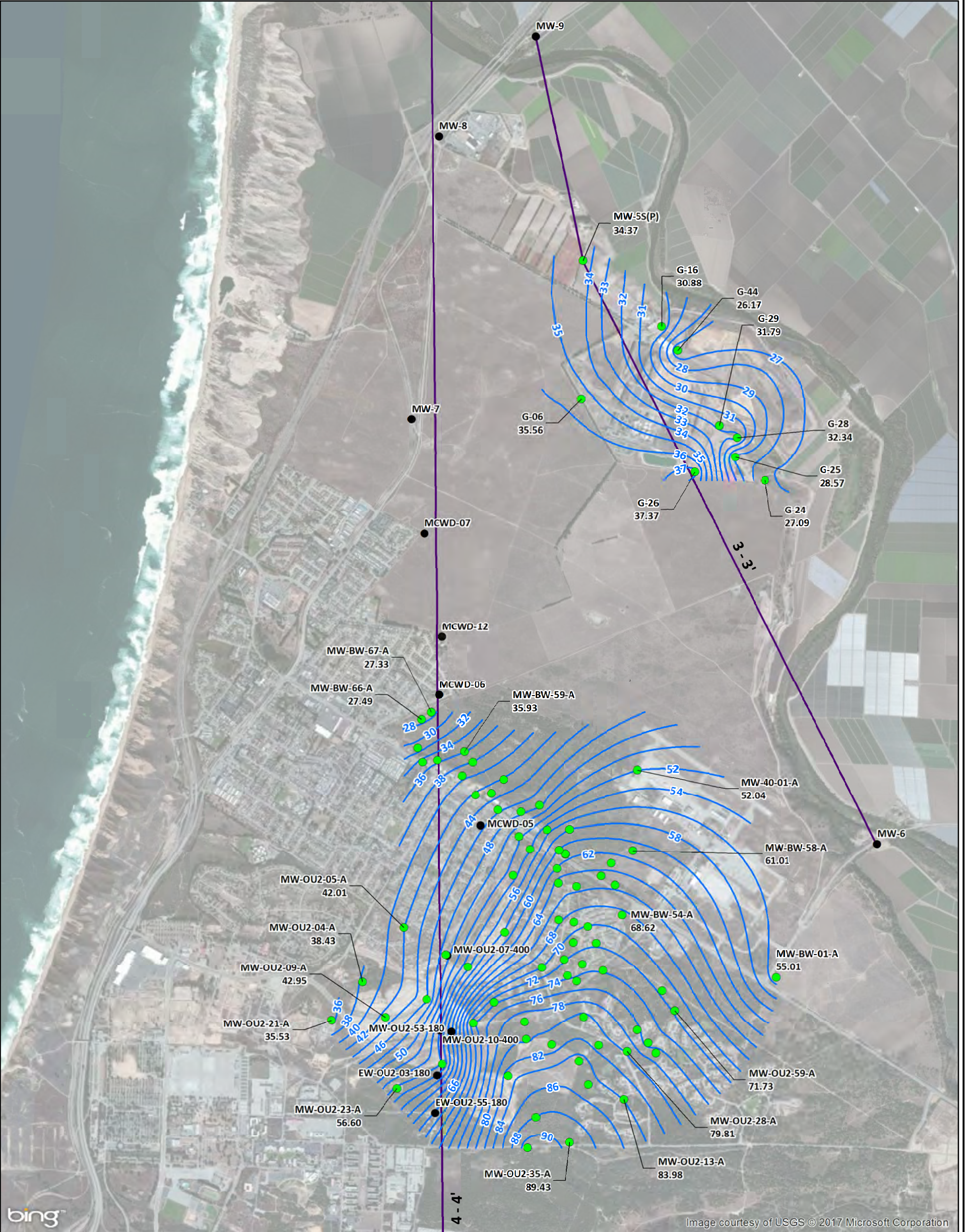
X:\Projects\MONTEREY AREA DESAL STUDIES\01a) Test Slant Well Project\01) Monitoring Wells\4) TM Monitoring Well Completion\03) Final TM Feb_17\Figures



GEOSCIENCE Support Services, Inc.
P.O. Box 220, Claremont, CA 91711
Tel: (909) 451-6650 Fax: (909) 451-6638
www.gssiwater.com

ILLUSTRATION OF
AQUIFER ZONES

Figure 8



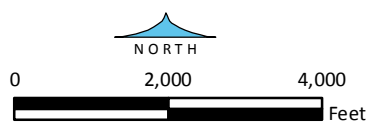
- Monitoring Well (used for contours)
- Other Well (not used for contours)
- 50— Groundwater Elevation (ft, NAVD88)
- Cross-Section Location

Note: Not all wells in the Fort Ord Area are labeled due to high density of wells.

**GROUNDWATER ELEVATIONS -
"PERCHED/MOUNDED AQUIFER"
(USING FORT ORD "A" AQUIFER WELLS,
MRWMD 35-FOOT AQUIFER WELLS,
AND MPWSP MW-5S(P))
FALL 2015**

8-Feb-17

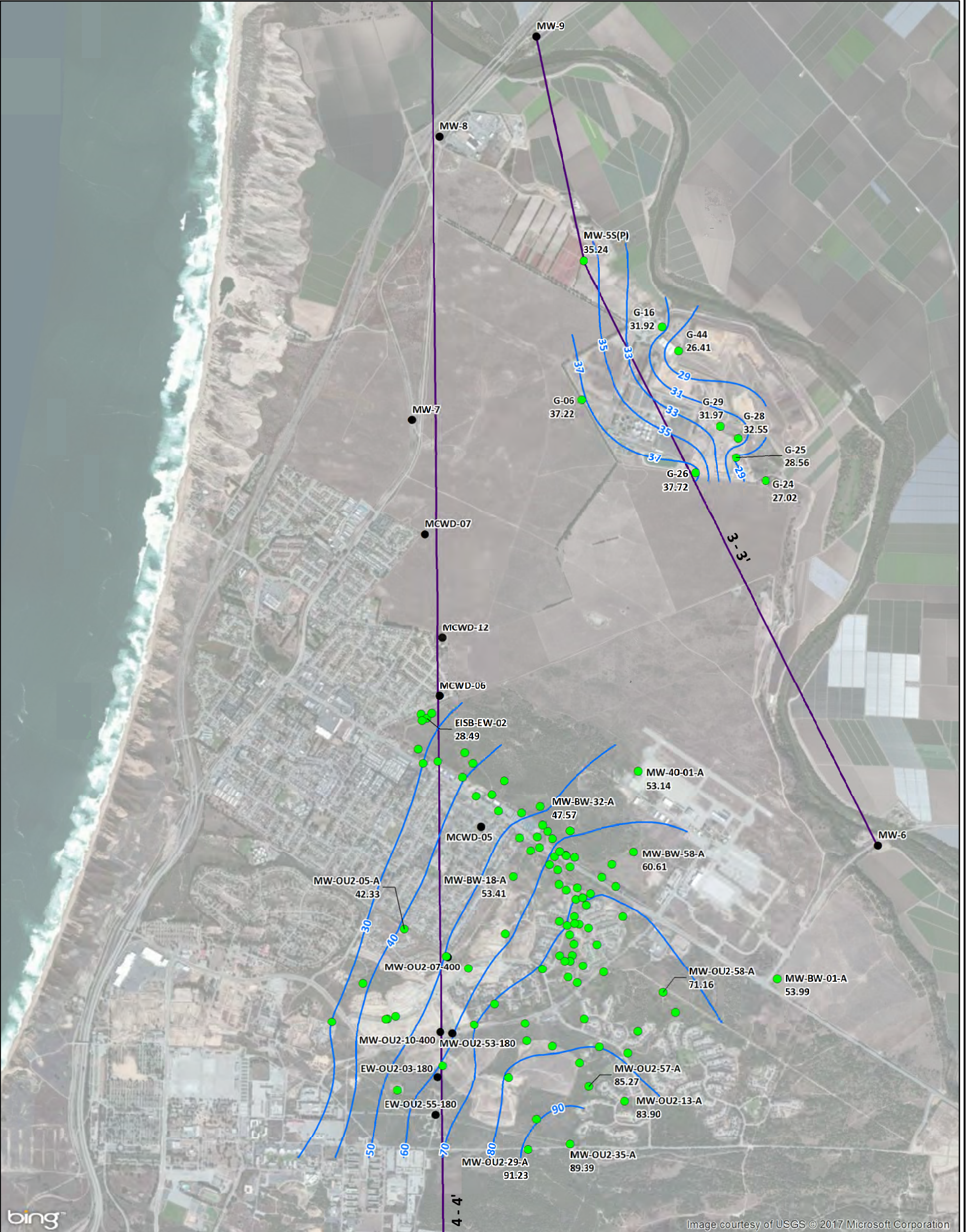
Prepared by: DB. Map Projection: State Plane 1983, Zone IV.
© 2017, GEOSCIENCE Support Services, Inc. All rights reserved.



GEOSCIENCE

GEOSCIENCE Support Services, Inc.
P.O. Box 220, Claremont, CA 91711
Tel: (909) 451-6650 Fax: (909) 451-6638
www.gssiwater.com

Figure 9

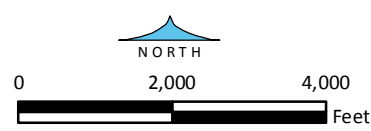


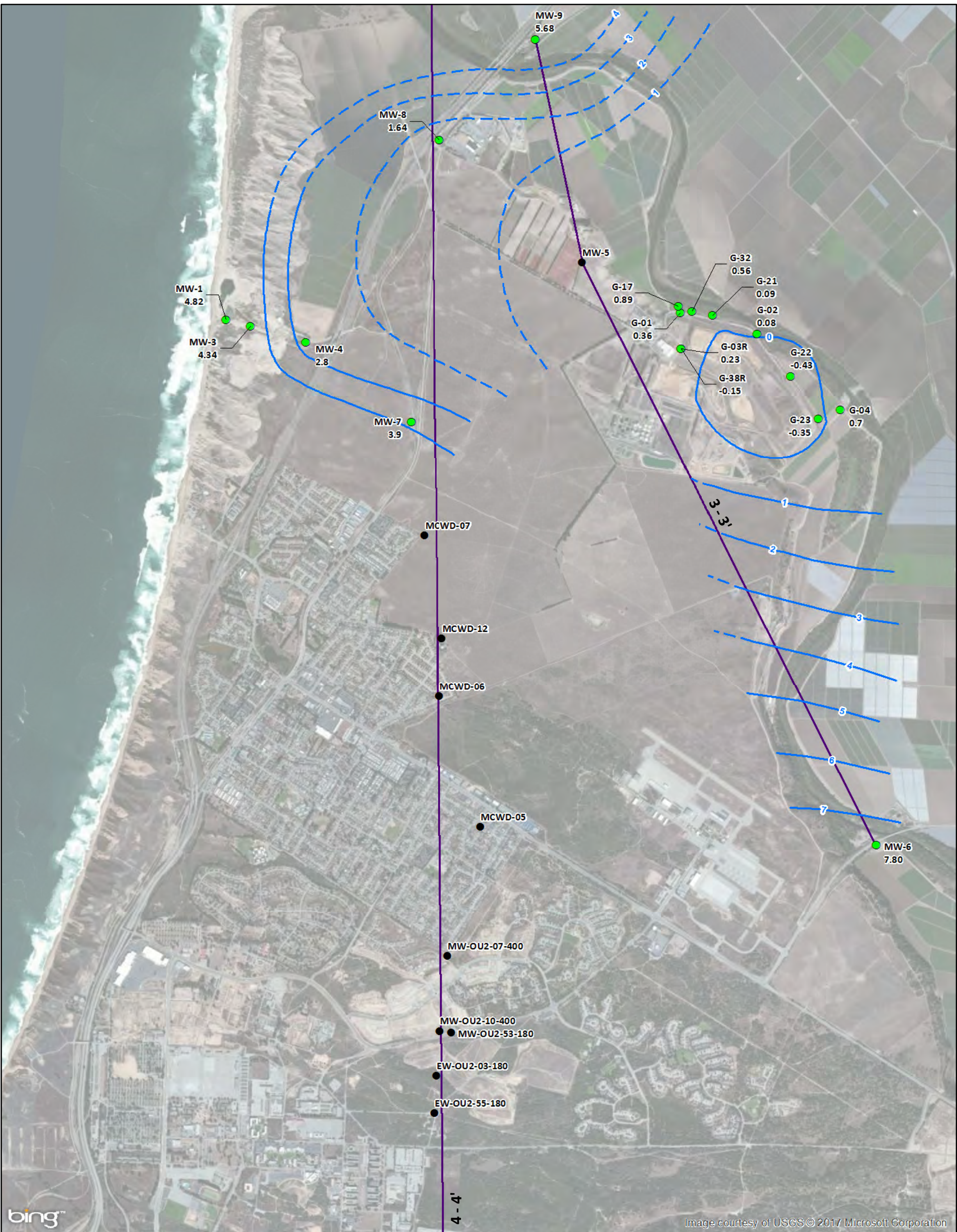
W:\GIS_proj\mowsp_cal_am\cal-am_CEMEX_model\Model_Calibration\10_Fig_10_Fort_Ord_A_MW-5s_and_Landfill_35ft_Aquifer_Spring_2016_2-17_V2.mxd

- Monitoring Well (used for contours)
- Other Well (not used for contours)
- 50— Groundwater Elevation (ft, NAVD88)
- Cross-Section Location

Note: Not all wells in the Fort Ord Area are labeled due to high density of wells.

**GROUNDWATER ELEVATIONS -
"PERCHED/MOUNDED AQUIFER"
(USING FORT ORD "A" AQUIFER WELLS,
MRWMD 35-FOOT AQUIFER WELLS,
AND MPWSP MW-5S(P))
SPRING 2016**



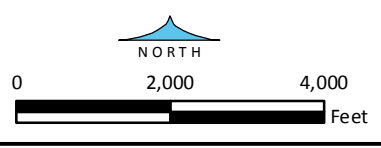


W:\GIS_proj\mwp_cal_am\cal-am_CEMEX_model\Model_Calibration\10_Fig_11_Fort_Ord_A_MWs_2ft_Aquifer_Well_Fall_2015_2-17.mxd

Image courtesy of USGS © 2017 Microsoft Corporation

- Monitoring Well (used for contours)
- Other Well (not used for contours)
- Groundwater Elevation (ft, NAVD88)
Dashed where inferred
- Cross-Section Location

**GROUNDWATER ELEVATIONS -
"DUNE SAND AQUIFER"
(USING MRWMD -2-FOOT AQUIFER WELLS
AND MPWSP SHALLOW COMPLECTIONS)
FALL 2015**





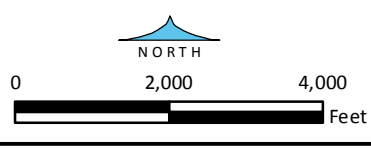
W:\GIS\proj\mrwsp_cal_aqi\cal-am_CEMEX_model\Model_Calibration\10_Fig_12_Fort_Ord_A_MWs_-2ft_Aquifer_Spring_2016_2-17.mxd

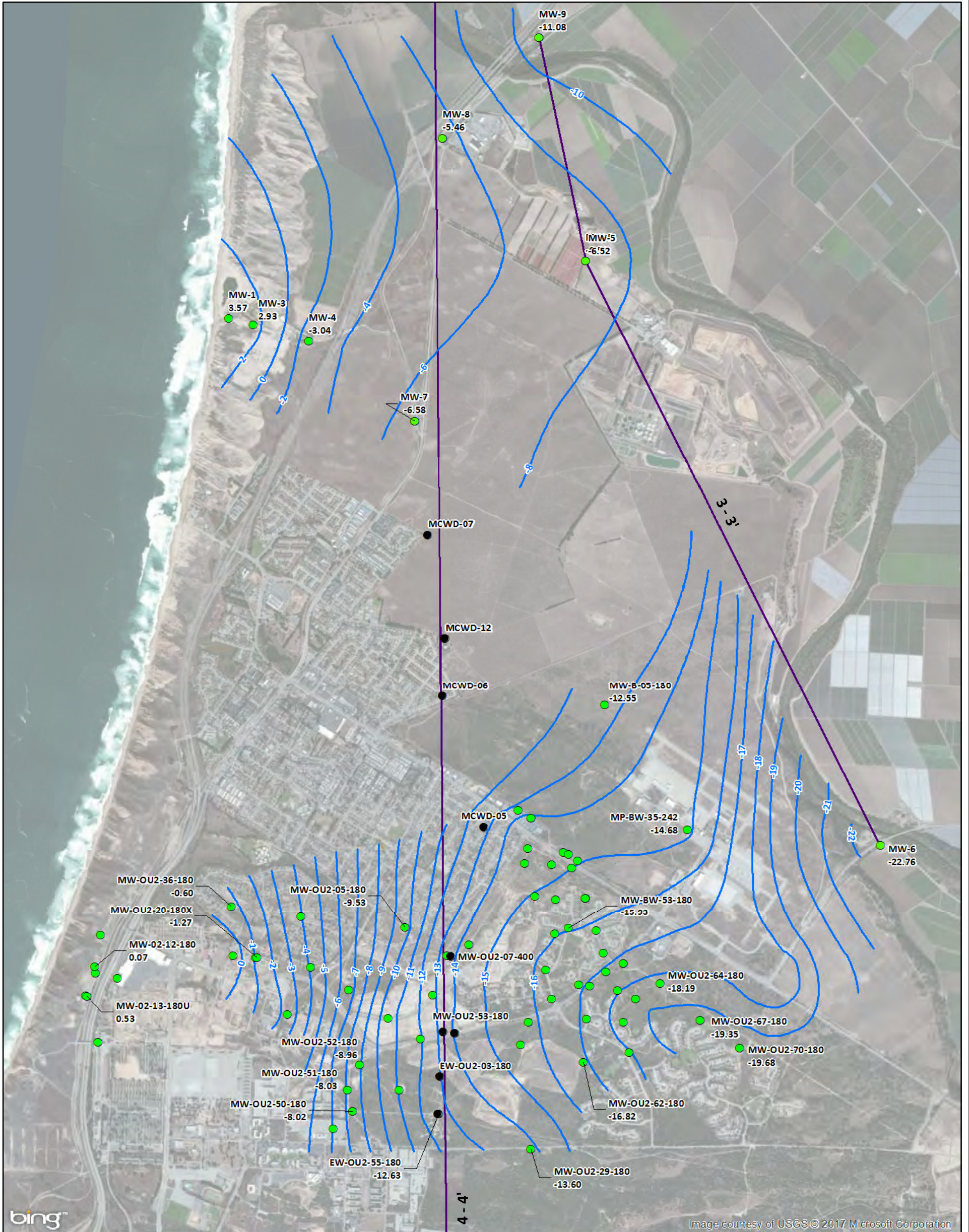


Image courtesy of USGS © 2017 Microsoft Corporation

- Monitoring Well (used for contours)
- Other Well (not used for contours)
- Groundwater Elevation (ft, NAVD88)
Dashed where inferred
- Cross-Section Location

**GROUNDWATER ELEVATIONS -
"DUNE SAND AQUIFER"
(USING MRWMD -2-FOOT AQUIFER WELLS
AND MPWSP SHALLOW COMPLECTIONS)
SPRING 2016**





W:\GIS_projects\mwp_cal_am\cam_CEMEX_model\Model_Calibration\10_Fig_13_Middle_MW's_(180ft)_Fort_Ord_Upper-180_Aquifer_Well_Fall_2015_2-17.mxd

Image courtesy of USGS © 2017 Microsoft Corporation

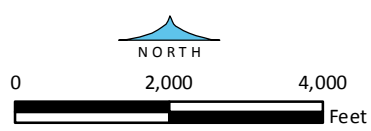
- Monitoring Well (used for contours)
- Other Well (not used for contours)
- 5- Groundwater Elevation (ft, NAVD88)
- Cross-Section Location

Note: Not all wells in the Fort Ord Area are labeled due to high density of wells.

**GROUNDWATER ELEVATIONS -
"180-FTE/180-FOOT AQUIFER"
(USING FORT ORD UPPER 180-FOOT
AQUIFER WELLS AND MPWSP
MIDDLE COMPLETIONS)
FALL 2015**

8-Feb-17

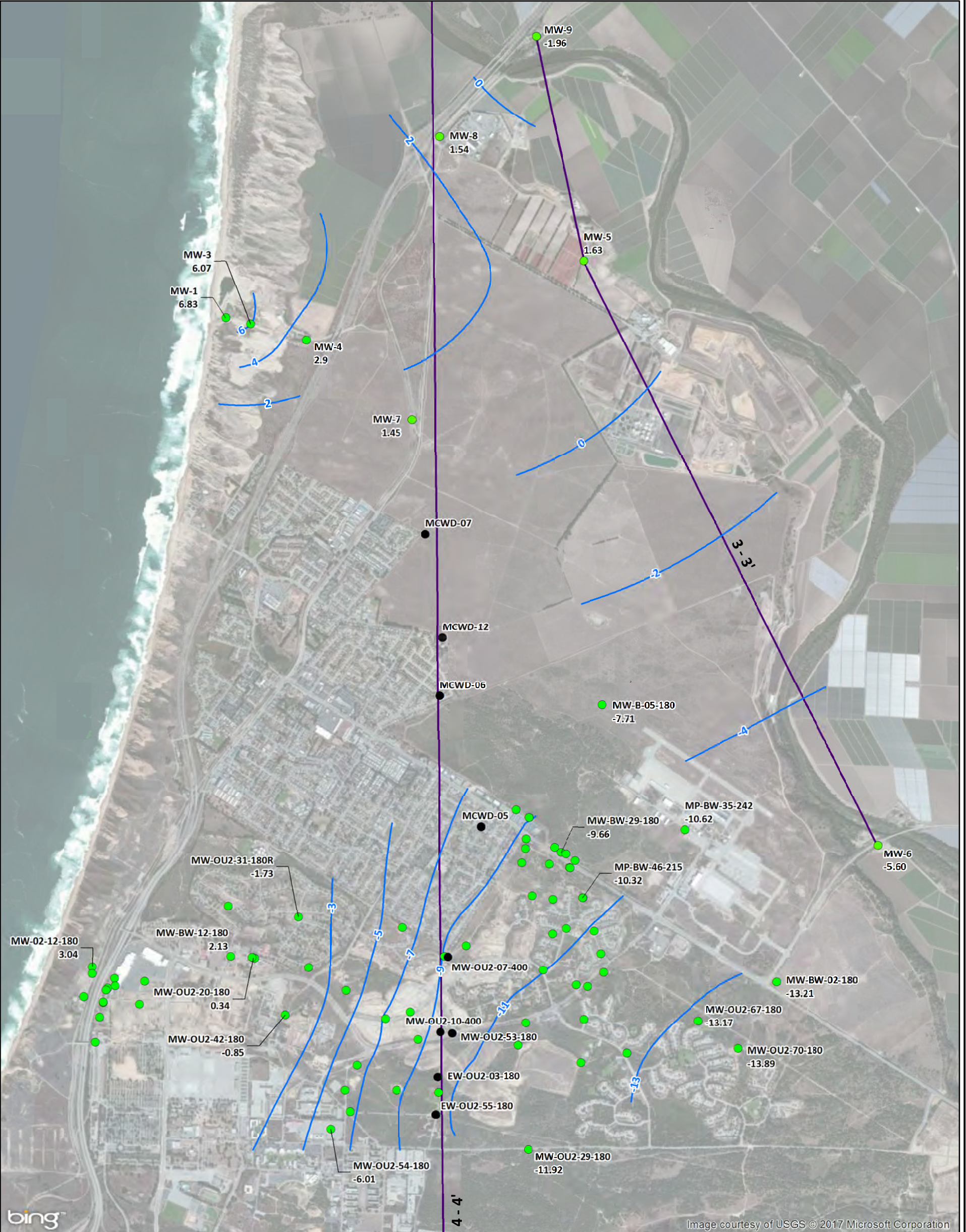
Prepared by: DB. Map Projection: State Plane 1983, Zone IV.
© 2017, GEOSCIENCE Support Services, Inc. All rights reserved.



GEOSCIENCE

GEOSCIENCE Support Services, Inc.
P.O. Box 220, Claremont, CA 91711
Tel: (909) 451-6650 Fax: (909) 451-6638
www.gssiwater.com

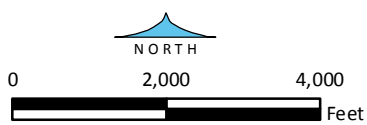
Figure 13



Note: Not all wells in the Fort Ord Area are labeled due to high density of wells.

8-Feb-17

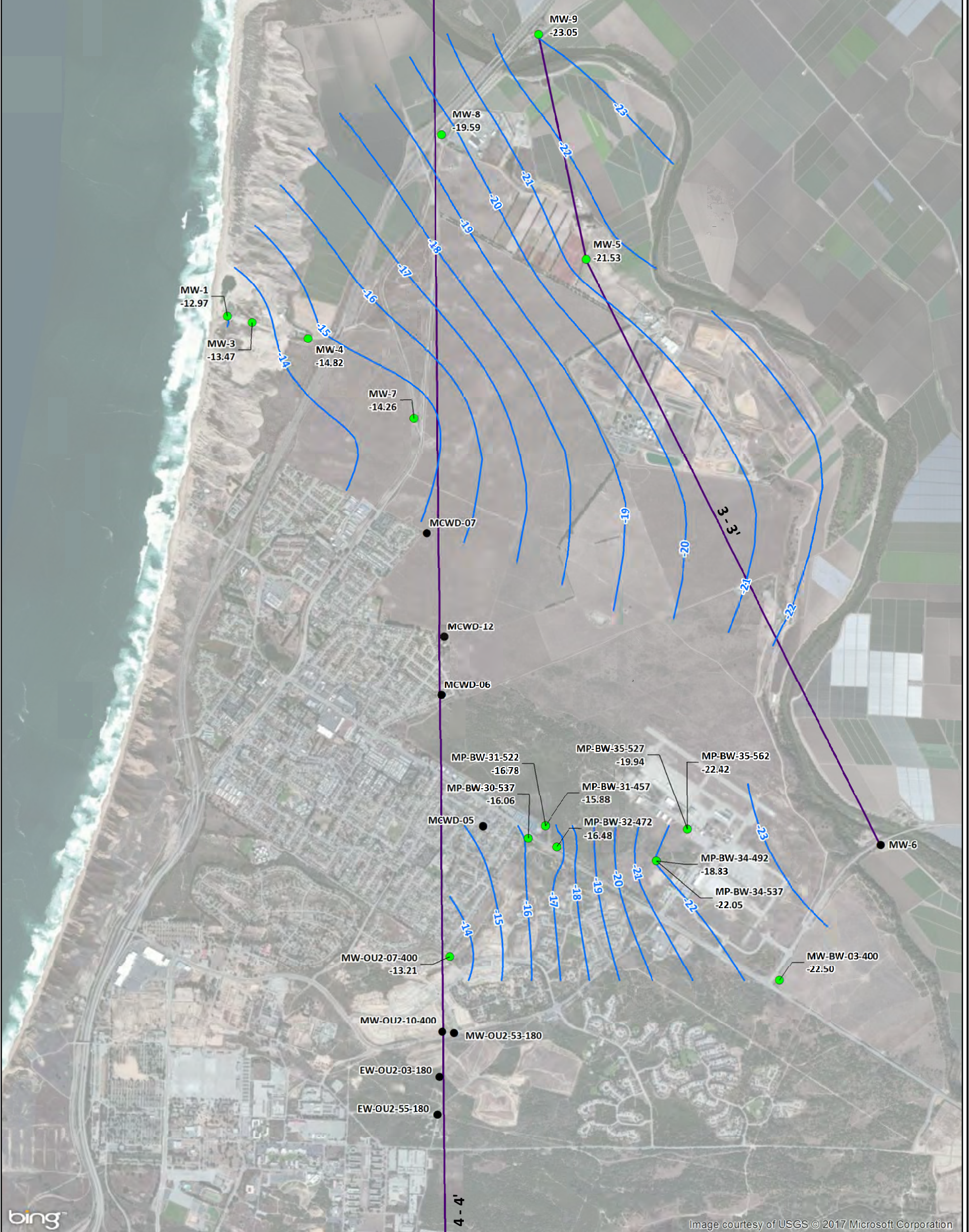
Prepared by: DB. Map Projection: State Plane 1983, Zone IV.
© 2017, GEOSCIENCE Support Services, Inc. All rights reserved.



GEOSCIENCE

GEOSCIENCE Support Services, Inc.
P.O. Box 220, Claremont, CA 91711
Tel: (909) 451-6650 Fax: (909) 451-6638
www.gssiwater.com

Figure 14



W:\GIS\proj\mncwsp_cal_am\cal-am_CEMEX_model\Model\Calibration\10_Fig_15_Deep_MW's_(400ft)_Fort_Ord_400ft_Aquifer_Fall_2015_2-17.mxd



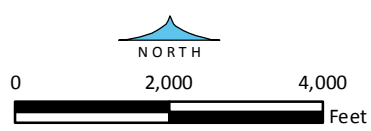
Image courtesy of USGS © 2017 Microsoft Corporation

- Monitoring Well (used for contours)
- Other Well (not used for contours)
- 15-- Groundwater Elevation (ft, NAVD88)
- Cross-Section Location

**GROUNDWATER ELEVATIONS -
"400-FOOT AQUIFER"
(USING FORT ORD 400-FOOT
AQUIFER WELLS AND
MPWSP DEEP COMPLETIONS)
FALL 2015**

8-Feb-17

Prepared by: DB. Map Projection: State Plane 1983, Zone IV.
© 2017, GEOSCIENCE Support Services, Inc. All rights reserved.



GEOSCIENCE Support Services, Inc.
P.O. Box 220, Claremont, CA 91711
Tel: (909) 451-6650 Fax: (909) 451-6638
www.gssiwater.com

Figure 15



W:\GIS_proj\mowsp_ral_am\cal-am_CEMEX_model\Model_Calibration\10_Fig_16_Deep_MW's_(400ft)_Fort_Ord_400ft_Aquifer_Spring_2016_2-17.mxd



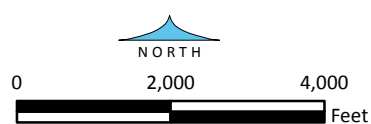
Image courtesy of USGS © 2017 Microsoft Corporation

- Monitoring Well (used for contours)
- Other Well (not used for contours)
- Groundwater Elevation (ft, NAVD88)
- Cross-Section Location

**GROUNDWATER ELEVATIONS -
"400-FOOT AQUIFER"
(USING FORT ORD 400-FOOT
AQUIFER WELLS AND
MPWSP DEEP COMPLETIONS)
SPRING 2016**

8-Feb-17

Prepared by: DB. Map Projection: State Plane 1983, Zone IV.
© 2017, GEOSCIENCE Support Services, Inc. All rights reserved.

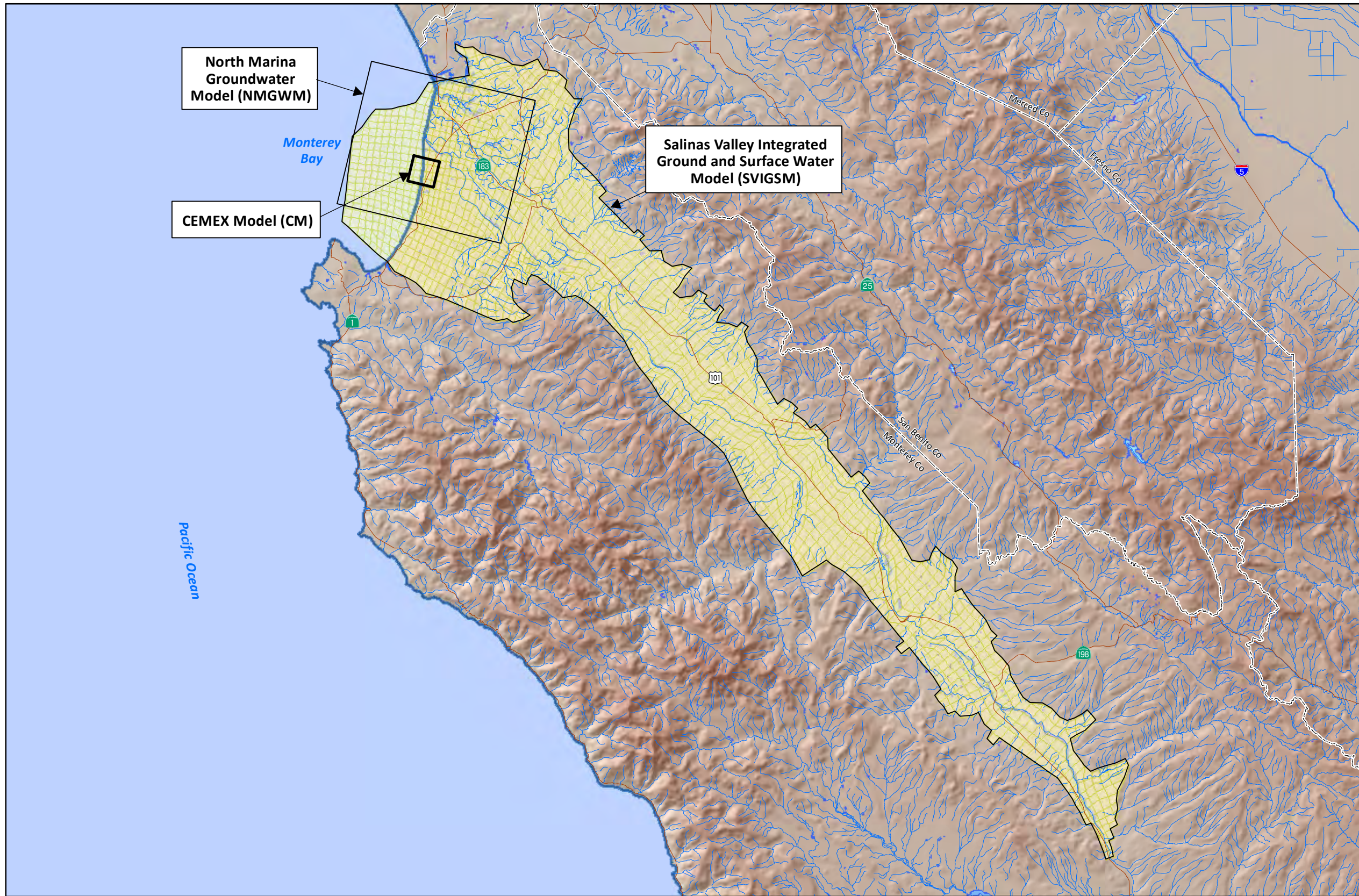


GEOSCIENCE

GEOSCIENCE Support Services, Inc.
P.O. Box 220, Claremont, CA 91711
Tel: (909) 451-6650 Fax: (909) 451-6638
www.gssiwater.com

Figure 16

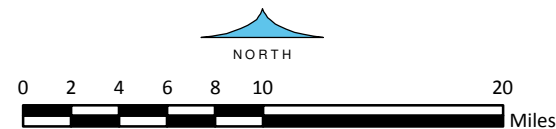
**GROUNDWATER
MODEL BOUNDARIES**



8-Feb-17

Prepared by: DB. Map Projection: State Plane 1983, Zone IV.

© 2017, GEOSCIENCE Support Services, Inc. All rights reserved.

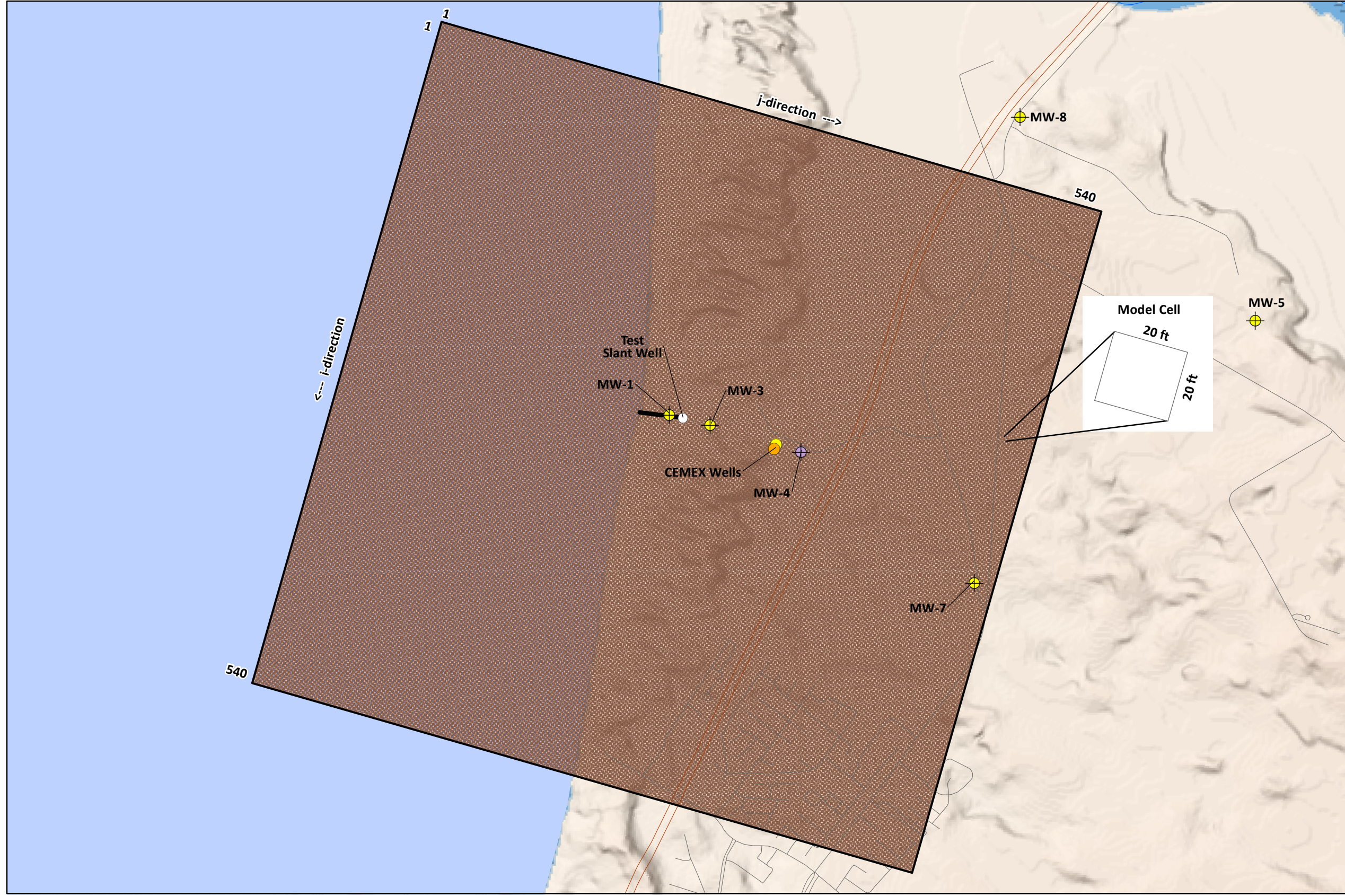








GEOSCIENCE

GEOSCIENCE Support Services, Inc.
P.O. Box 220, Claremont, CA 91711
Tel: (909) 451-6650 Fax: (909) 451-6638
www.gssiwater.com

Figure 17

CEMEX MODEL GRID

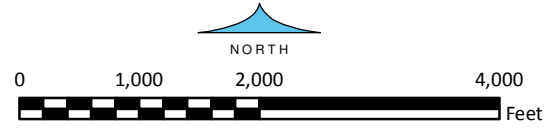


- EXPLANATION
-  CEMEX Model Boundary
 -  Monitoring Well Cluster
 -  Compliance Monitoring Well Cluster
 -  CEMEX Well - Inactive (Monitored)
 -  CEMEX Well - Active (Not Monitored)
 -  Test Slant Well

8-Feb-17

Prepared by: DB. Map Projection: State Plane 1983, Zone IV.

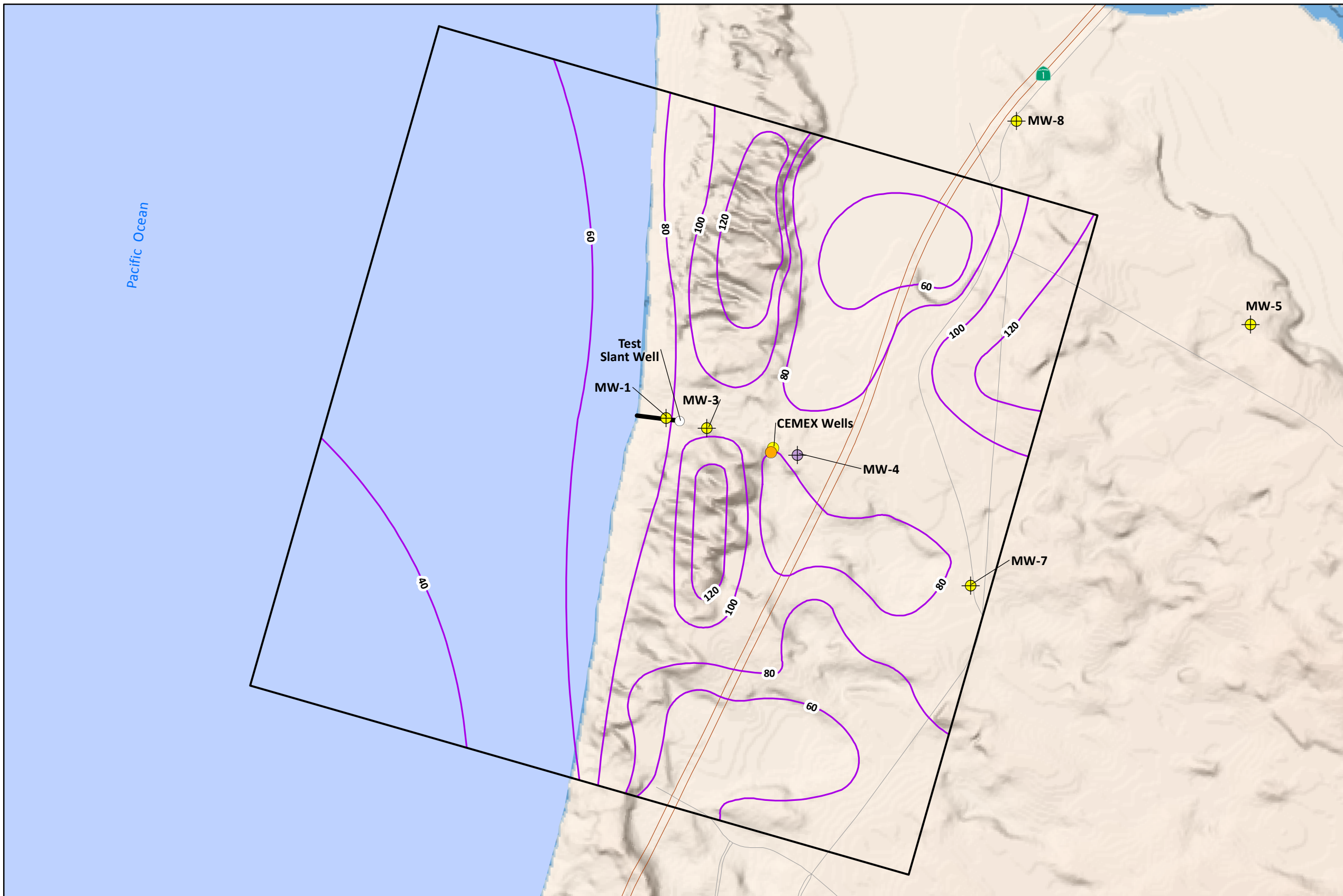
© 2017, GEOSCIENCE Support Services, Inc. All rights reserved.



GEOSCIENCE Support Services, Inc.
P.O. Box 220, Claremont, CA 91711
Tel: (909) 451-6650 Fax: (909) 451-6638
www.gssiwater.com








Figure 18

W:\GIS_proj\mcwsp_cal_am\cal-am_CEMEX_model\Model_Calibration\10_Fig_18_CEMEX_model_grid_2-17.mxd



**UPDATED THICKNESS
OF THE
DUNE SAND AQUIFER
(CEMEX MODEL
LAYERS 2-4)**

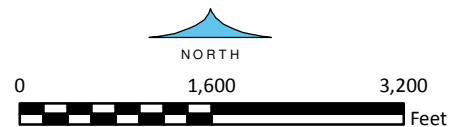
EXPLANATION

-  Aquifer Thickness (ft)
-  CEMEX Model Boundary
-  Monitoring Well Cluster
-  Compliance Monitoring Well Cluster
-  CEMEX Well - Inactive (Monitored)
-  CEMEX Well - Active (Not Monitored)
-  Test Slant Well

8-Feb-17

Prepared by: DB. Map Projection: State Plane 1983, Zone IV.

© 2017, GEOSCIENCE Support Services, Inc. All rights reserved.

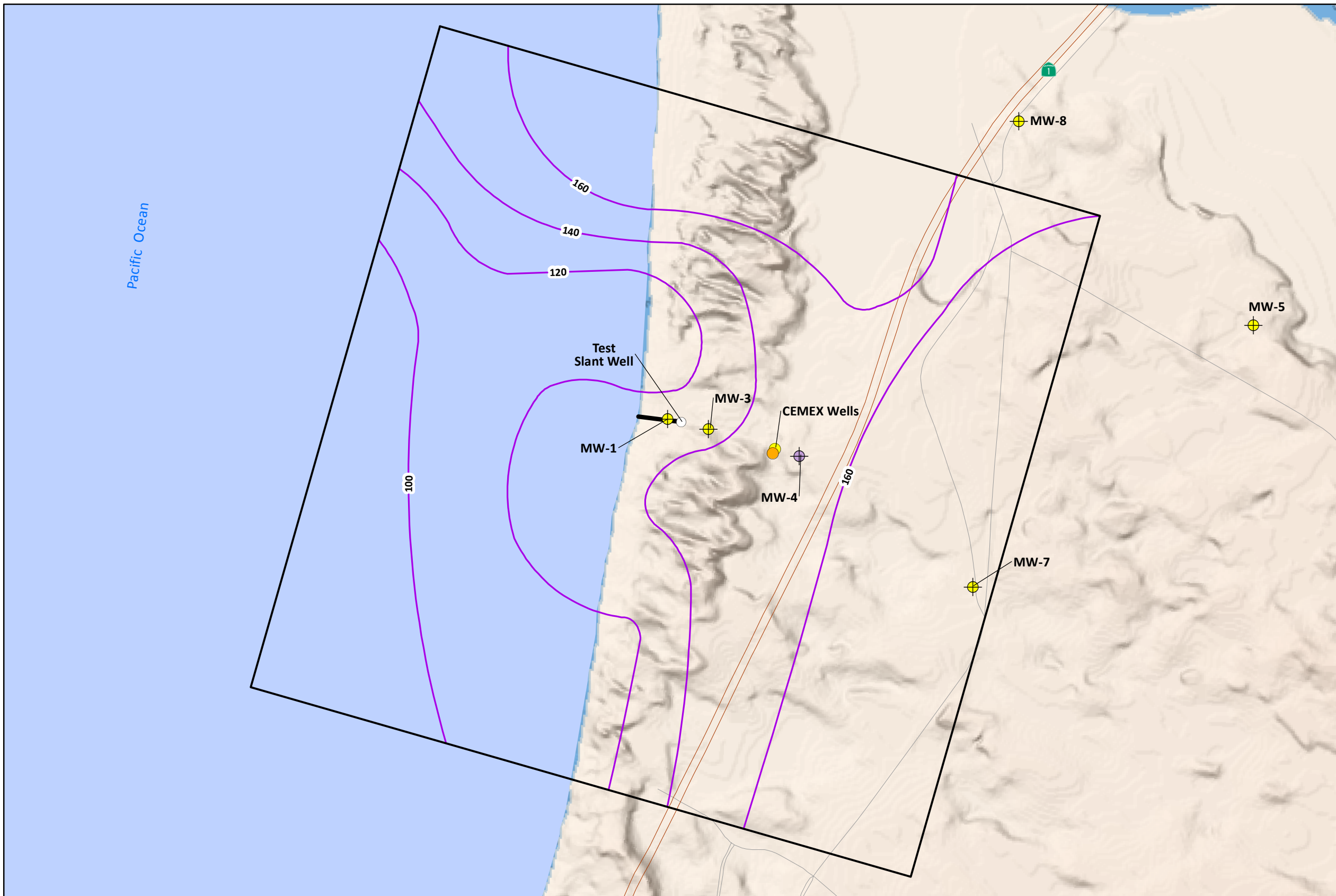


GEOSCIENCE








GEOSCIENCE Support Services, Inc.
P.O. Box 220, Claremont, CA 91711
Tel: (909) 451-6650 Fax: (909) 451-6638
www.gssiwater.com

Figure 19

**UPDATED THICKNESS
OF THE
180-FTE AQUIFER
(CEMEX MODEL
LAYERS 6-8)**



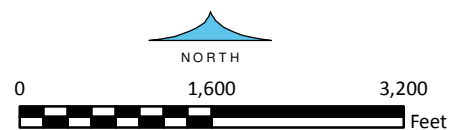
EXPLANATION

-  Aquifer Thickness (ft)
-  CEMEX Model Boundary
-  Monitoring Well Cluster
-  Compliance Monitoring Well Cluster
-  CEMEX Well - Inactive (Monitored)
-  CEMEX Well - Active (Not Monitored)
-  Test Slant Well

8-Feb-17

Prepared by: DB. Map Projection: State Plane 1983, Zone IV.

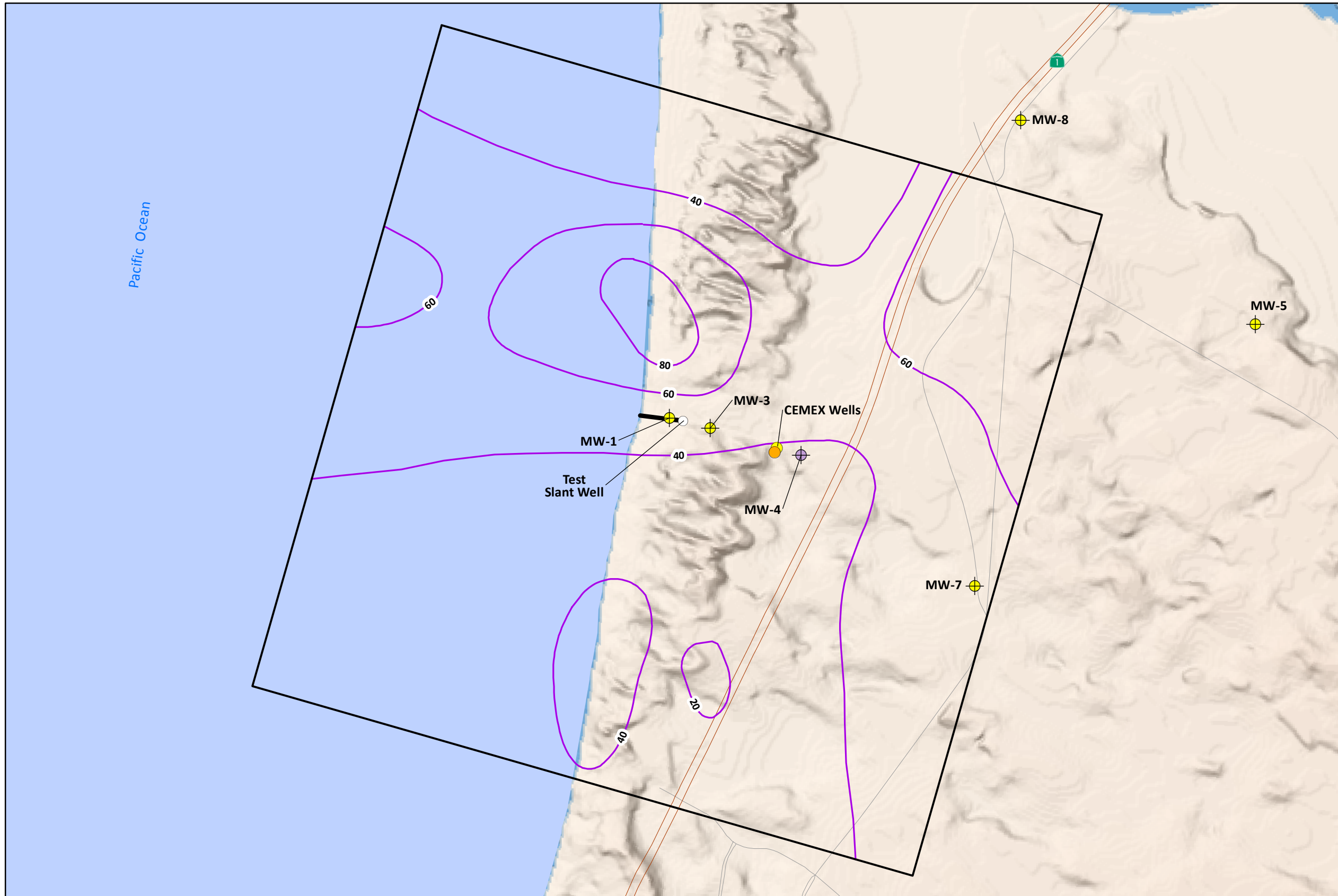
© 2017, GEOSCIENCE Support Services, Inc. All rights reserved.



GEOSCIENCE








GEOSCIENCE Support Services, Inc.
P.O. Box 220, Claremont, CA 91711
Tel: (909) 451-6650 Fax: (909) 451-6638
www.gssiwater.com

Figure 20



**UPDATED THICKNESS
OF THE
180/400-FT AQUITARD
(CEMEX MODEL
LAYER 9)**

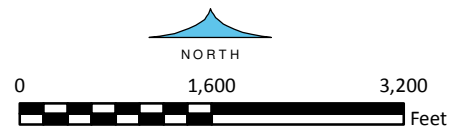
EXPLANATION

-  Aquifer Thickness (ft)
-  CEMEX Model Boundary
-  Monitoring Well Cluster
-  Compliance Monitoring Well Cluster
-  CEMEX Well - Inactive (Monitored)
-  CEMEX Well - Active (Not Monitored)
-  Test Slant Well

8-Feb-17

Prepared by: DB. Map Projection: State Plane 1983, Zone IV.

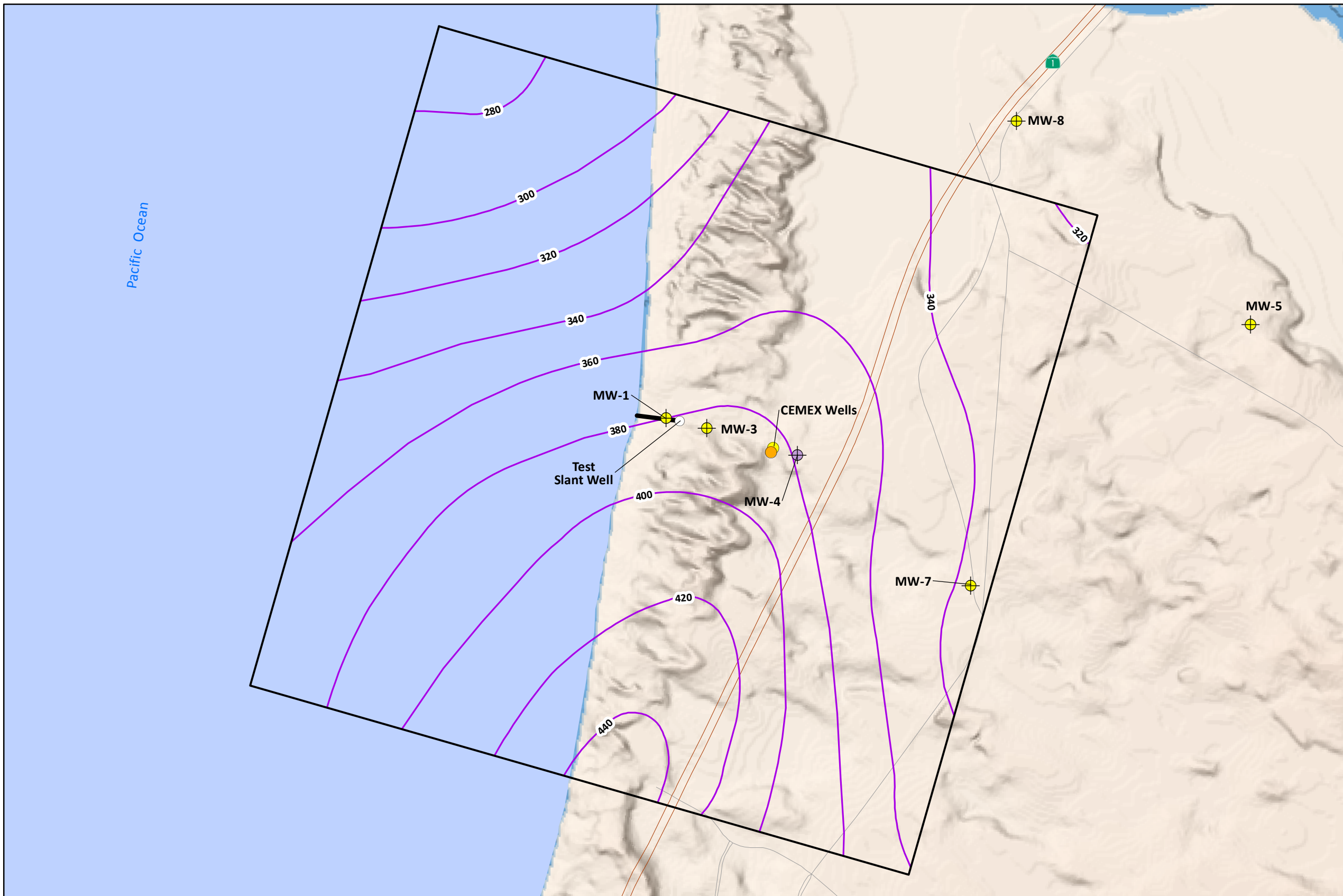
© 2017, GEOSCIENCE Support Services, Inc. All rights reserved.



GEOSCIENCE








GEOSCIENCE Support Services, Inc.
P.O. Box 220, Claremont, CA 91711
Tel: (909) 451-6650 Fax: (909) 451-6638
www.gssiwater.com

Figure 21



**UPDATED THICKNESS
OF THE
400-FT AQUIFER
(CEMEX MODEL
LAYER 10)**

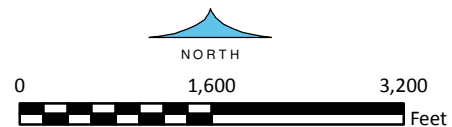
EXPLANATION

-  Aquifer Thickness (ft)
-  CEMEX Model Boundary
-  Monitoring Well Cluster
-  Compliance Monitoring Well Cluster
-  CEMEX Well - Inactive (Monitored)
-  CEMEX Well - Active (Not Monitored)
-  Test Slant Well

8-Feb-17

Prepared by: DB. Map Projection: State Plane 1983, Zone IV.

© 2017, GEOSCIENCE Support Services, Inc. All rights reserved.

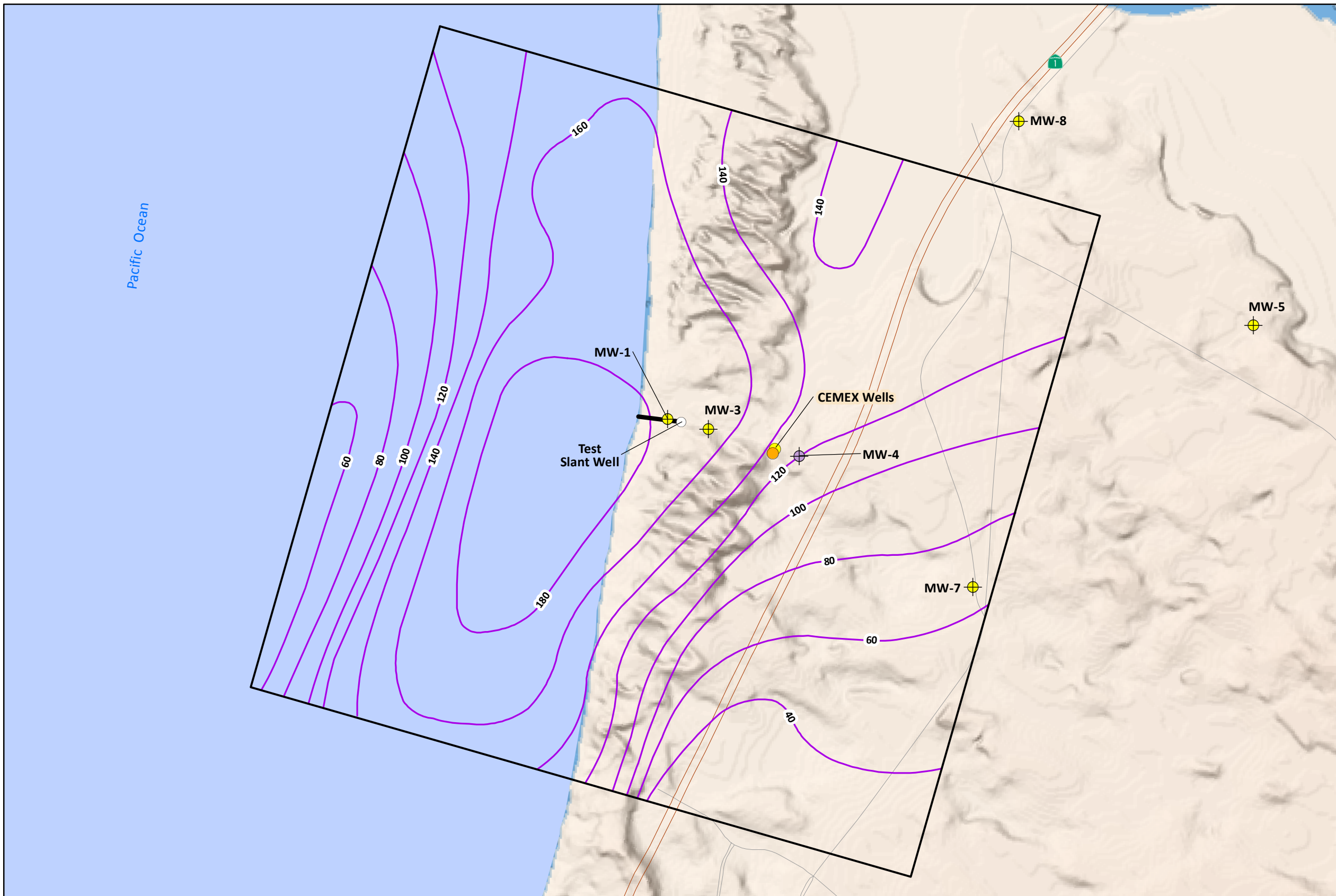


GEOSCIENCE








GEOSCIENCE Support Services, Inc.
P.O. Box 220, Claremont, CA 91711
Tel: (909) 451-6650 Fax: (909) 451-6638
www.gssiwater.com

Figure 22

**UPDATED THICKNESS
OF THE
400/900-FT AQUITARD
(CEMEX MODEL
LAYER 11)**



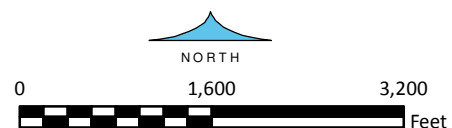
EXPLANATION

-  Aquifer Thickness (ft)
-  CEMEX Model Boundary
-  Monitoring Well Cluster
-  Compliance Monitoring Well Cluster
-  CEMEX Well - Inactive (Monitored)
-  CEMEX Well - Active (Not Monitored)
-  Test Slant Well

8-Feb-17

Prepared by: DB. Map Projection: State Plane 1983, Zone IV.

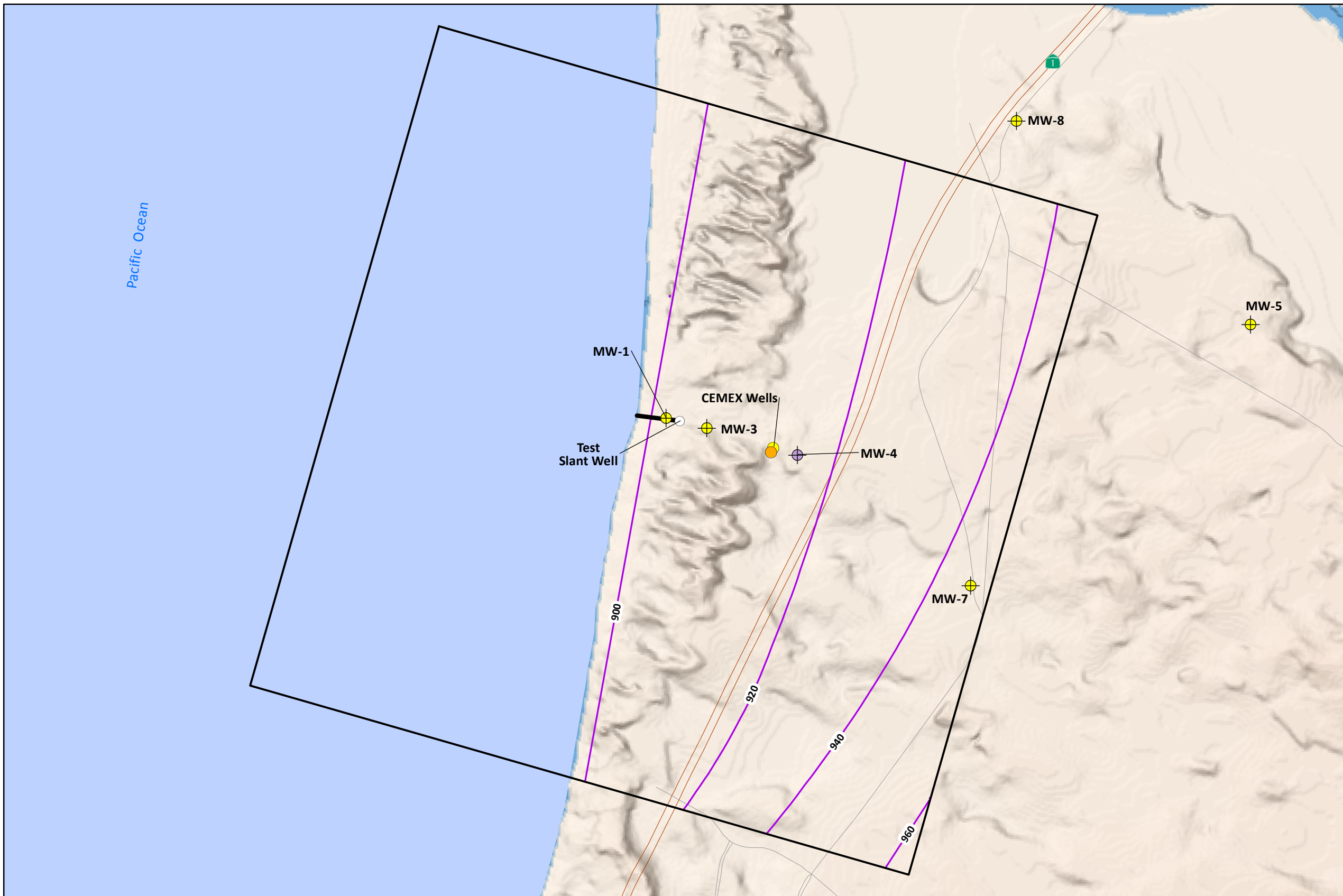
© 2017, GEOSCIENCE Support Services, Inc. All rights reserved.



GEOSCIENCE Support Services, Inc.
P.O. Box 220, Claremont, CA 91711
Tel: (909) 451-6650 Fax: (909) 451-6638
www.gssiwater.com








Figure 23

W:\GIS_proj\mcwsp_cal_am\cal-am_CEMEX_model\Model_Calibration\10_Fig_23_CEMEX_Thickness_400-900FTAquitard_L11_2-17.mxd



**UPDATED THICKNESS
OF THE
900-FT AQUIFER
(CEMEX MODEL
LAYER 12)**

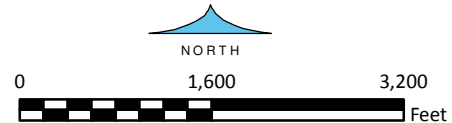
EXPLANATION

-  Aquifer Thickness (ft)
-  CEMEX Model Boundary
-  Monitoring Well Cluster
-  Compliance Monitoring Well Cluster
-  CEMEX Well - Inactive (Monitored)
-  CEMEX Well - Active (Not Monitored)
-  Test Slant Well

8-Feb-17

Prepared by: DB. Map Projection: State Plane 1983, Zone IV.

© 2017, GEOSCIENCE Support Services, Inc. All rights reserved.



GEOSCIENCE

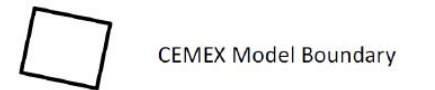
GEOSCIENCE Support Services, Inc.
P.O. Box 220, Claremont, CA 91711
Tel: (909) 451-6650 Fax: (909) 451-6638
www.gssiwater.com

Figure 24



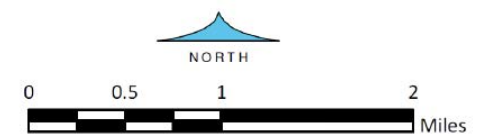
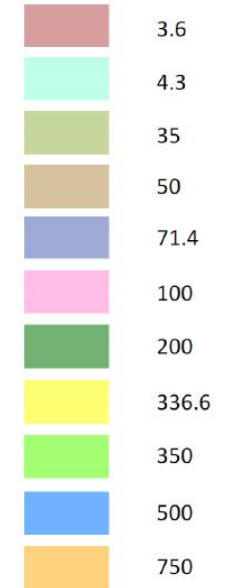
**CALIBRATED HORIZONTAL
HYDRAULIC CONDUCTIVITY
OF THE CM**

EXPLANATION



No-Flow Cell

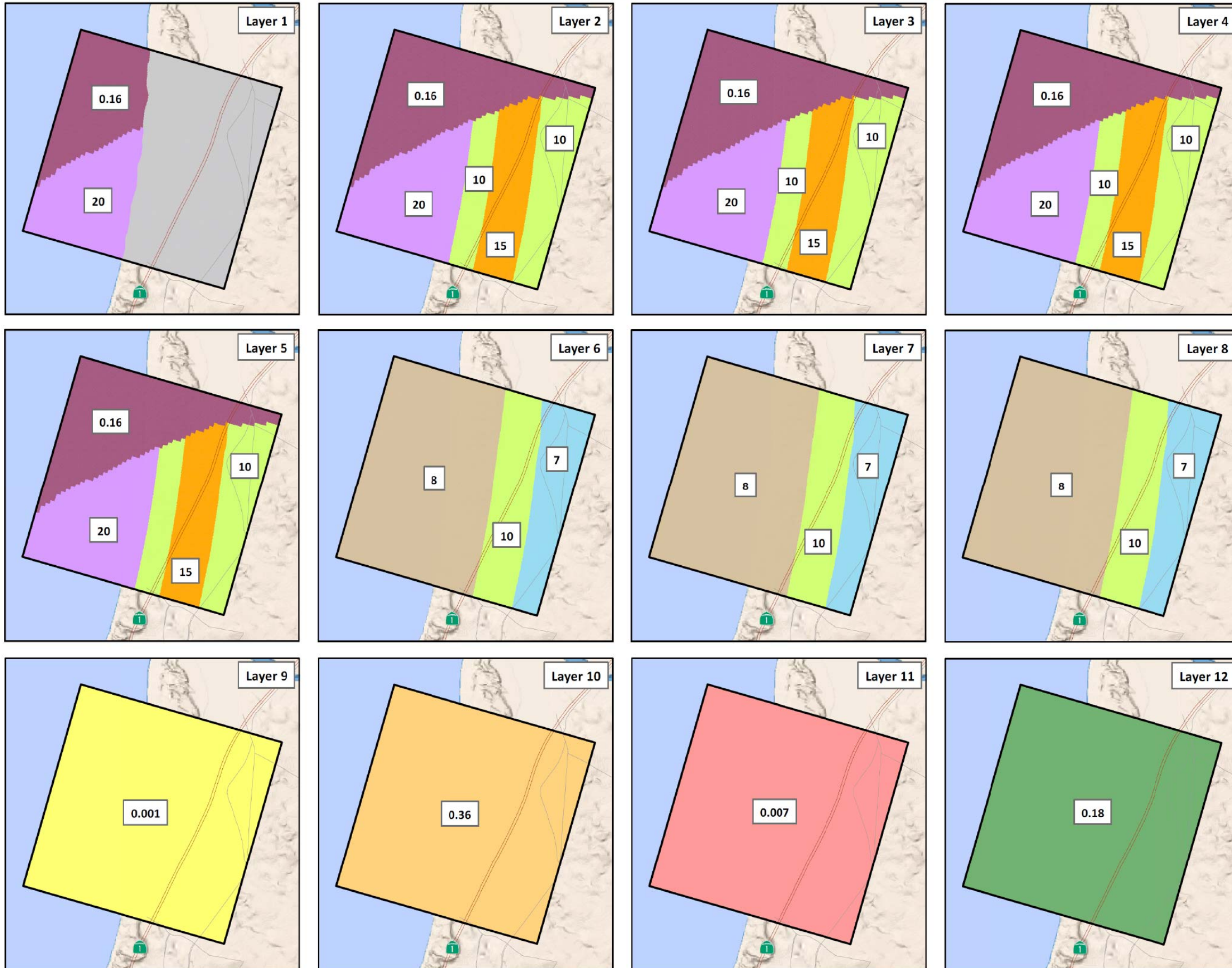
Hydraulic Conductivity (ft/day)



GEOSCIENCE

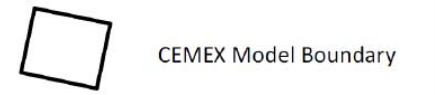
GEOSCIENCE Support Services, Inc.
P.O. Box 220, Claremont, CA 91711
Tel: (909) 451-6650 Fax: (909) 451-6638
www.gssiwater.com

Figure 25



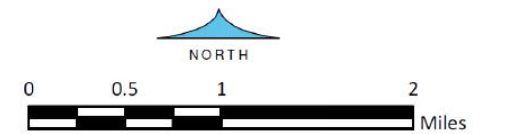
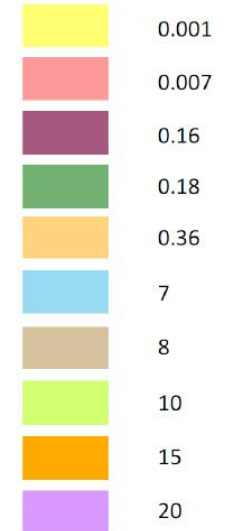
**CALIBRATED VERTICAL
HYDRAULIC CONDUCTIVITY
OF THE CM**

EXPLANATION



No-Flow Cell

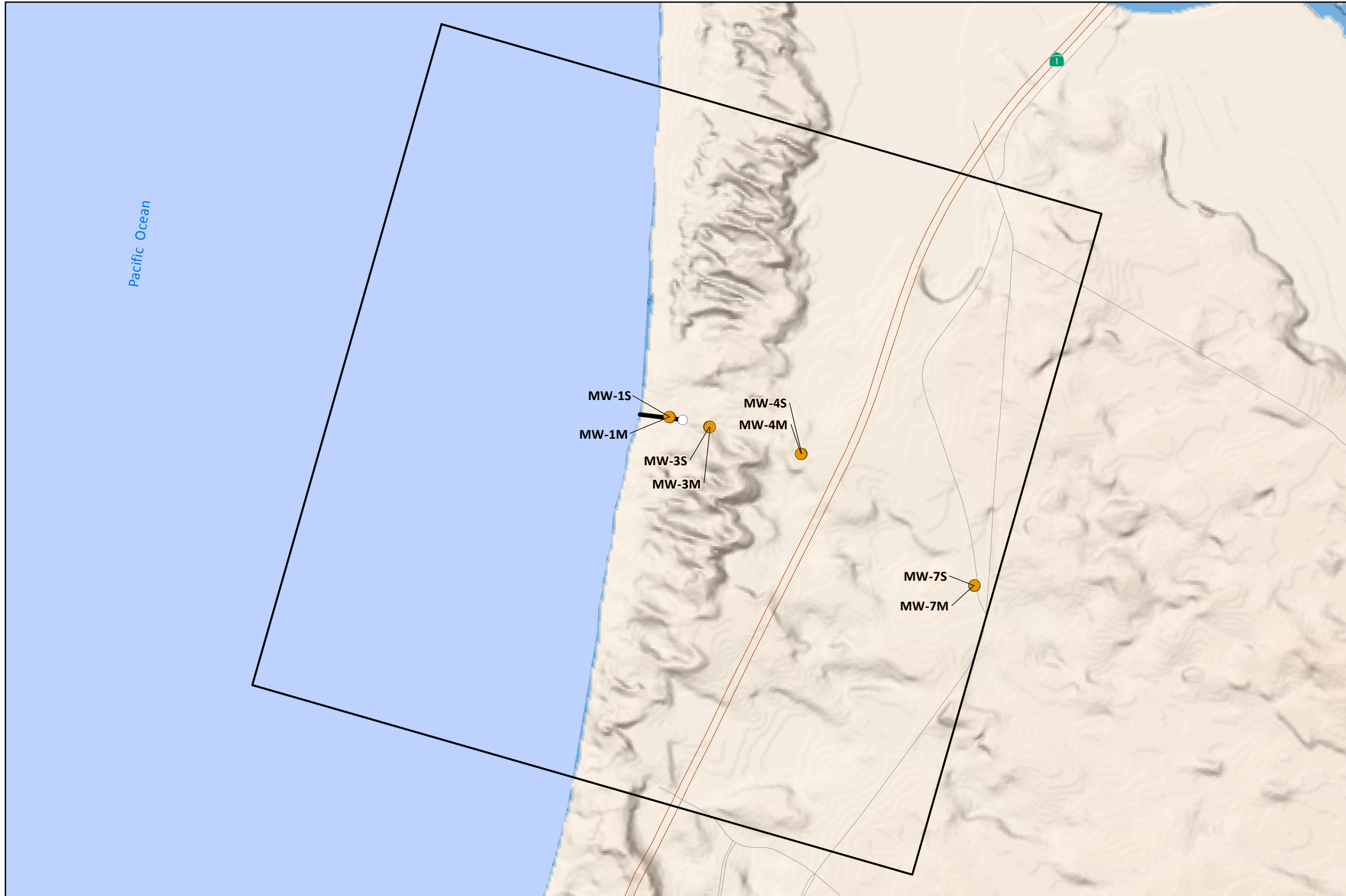
Hydraulic Conductivity (ft/day)






GEOSCIENCE

GEOSCIENCE Support Services, Inc.
P.O. Box 220, Claremont, CA 91711
Tel: (909) 451-6650 Fax: (909) 451-6638
www.gssiwater.com

**CEMEX MODEL
CALIBRATION
TARGET WELLS**



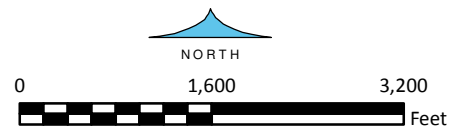
EXPLANATION

-  CEMEX Model Boundary
-  Calibration Target Well
-  Test Slant Well

8-Feb-17

Prepared by: DB. Map Projection: State Plane 1983, Zone IV.

© 2017, GEOSCIENCE Support Services, Inc. All rights reserved.



GEOSCIENCE

GEOSCIENCE Support Services, Inc.
P.O. Box 220, Claremont, CA 91711
Tel: (909) 451-6650 Fax: (909) 451-6638
www.gssiwater.com

Figure 27

Groundwater Pumping during Model Calibration Period (22-Apr-15 through 13-Jan-16)

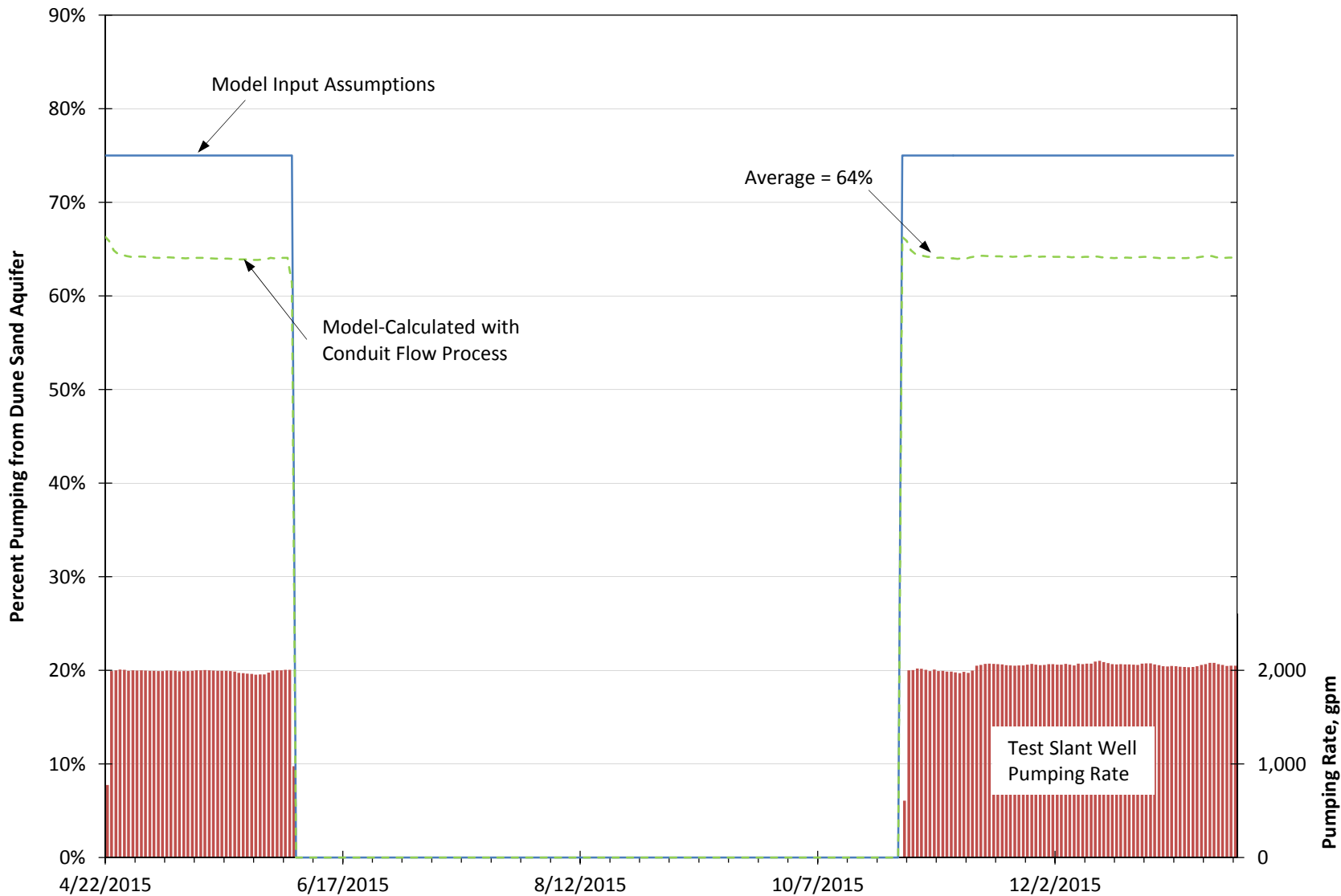


Figure 28

Drawdown Calculation for MW-1S

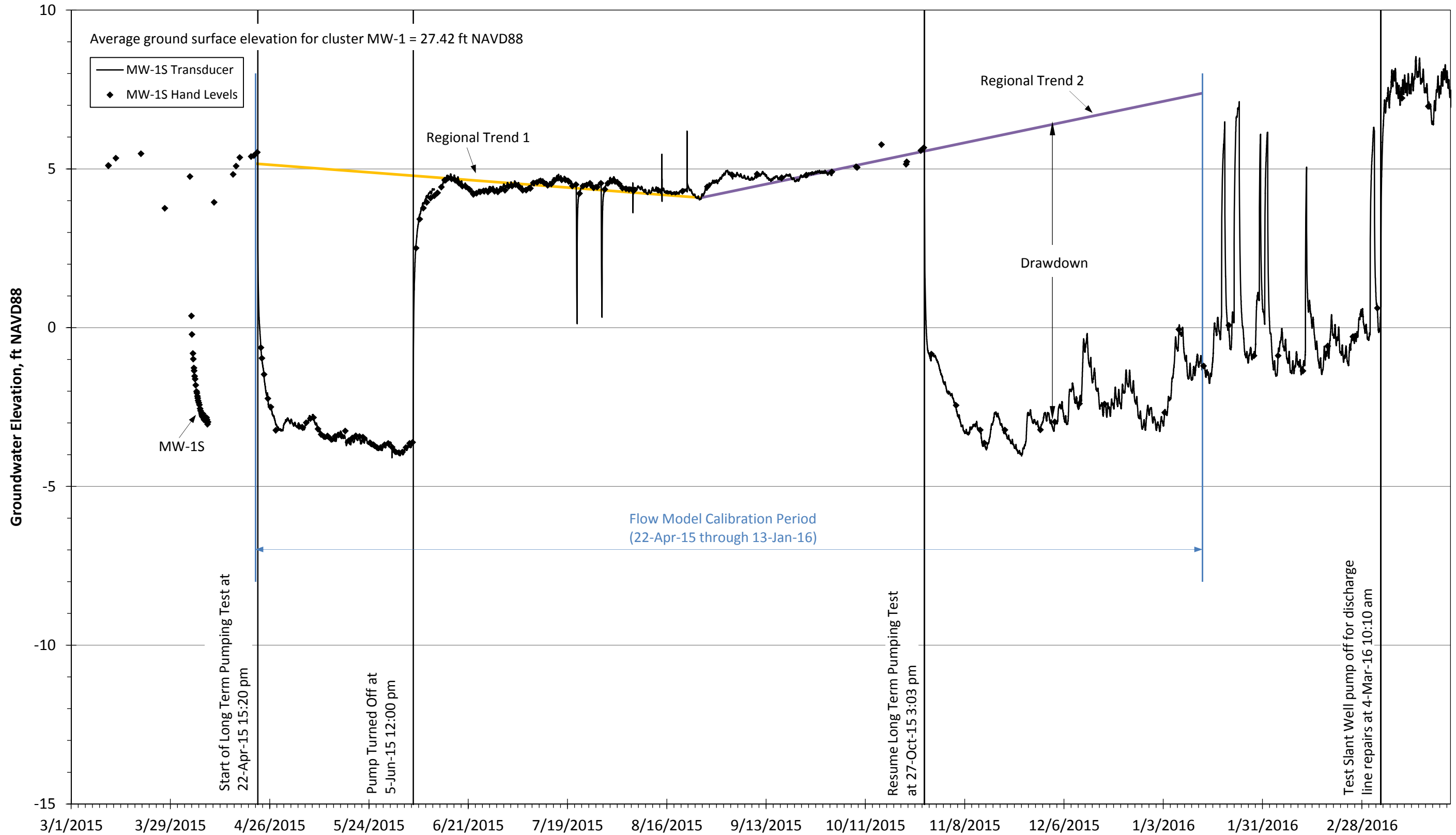


Figure 29

Drawdown Calculation for MW-1M

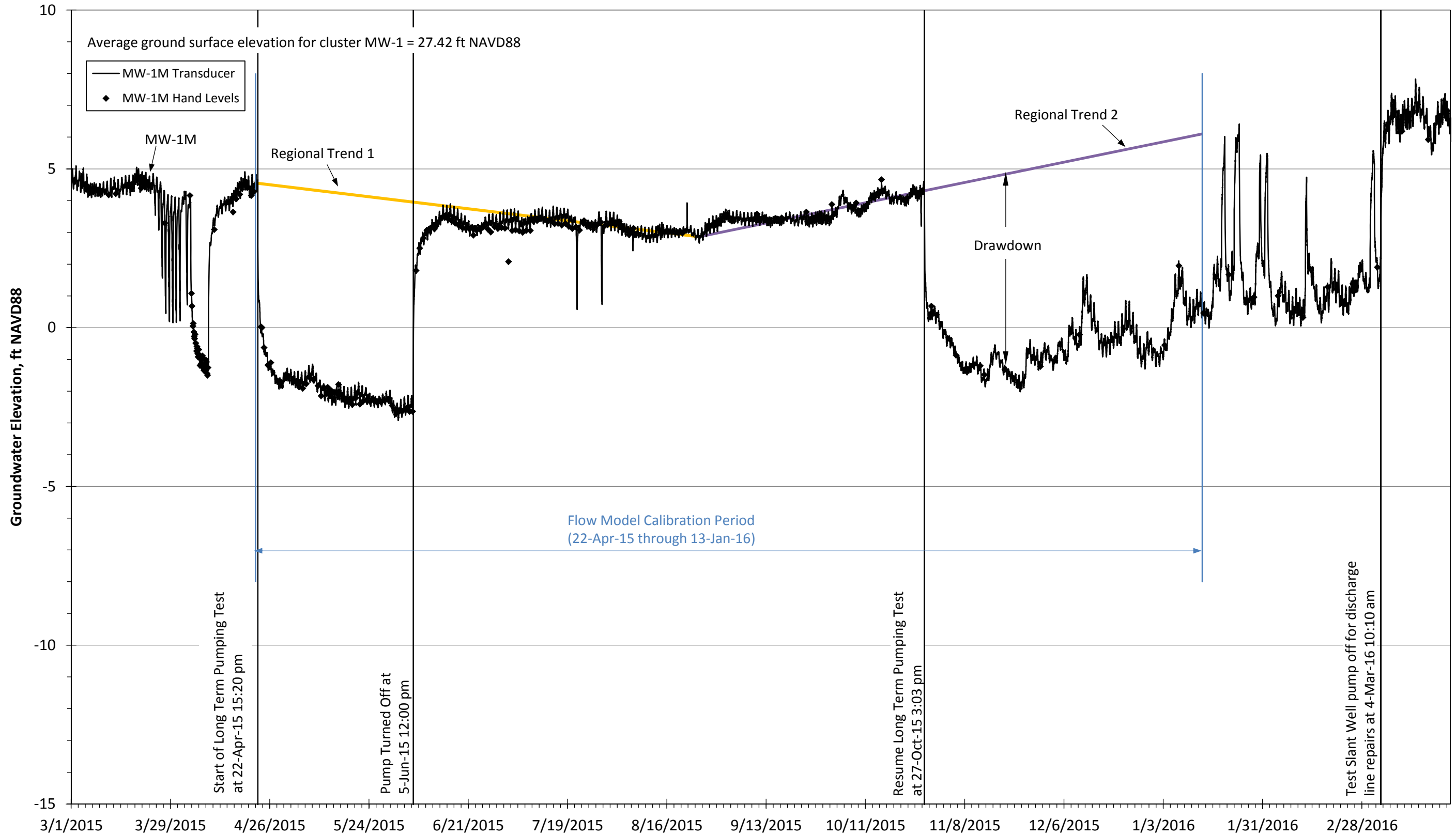


Figure 30

Drawdown Calculation for MW-3S

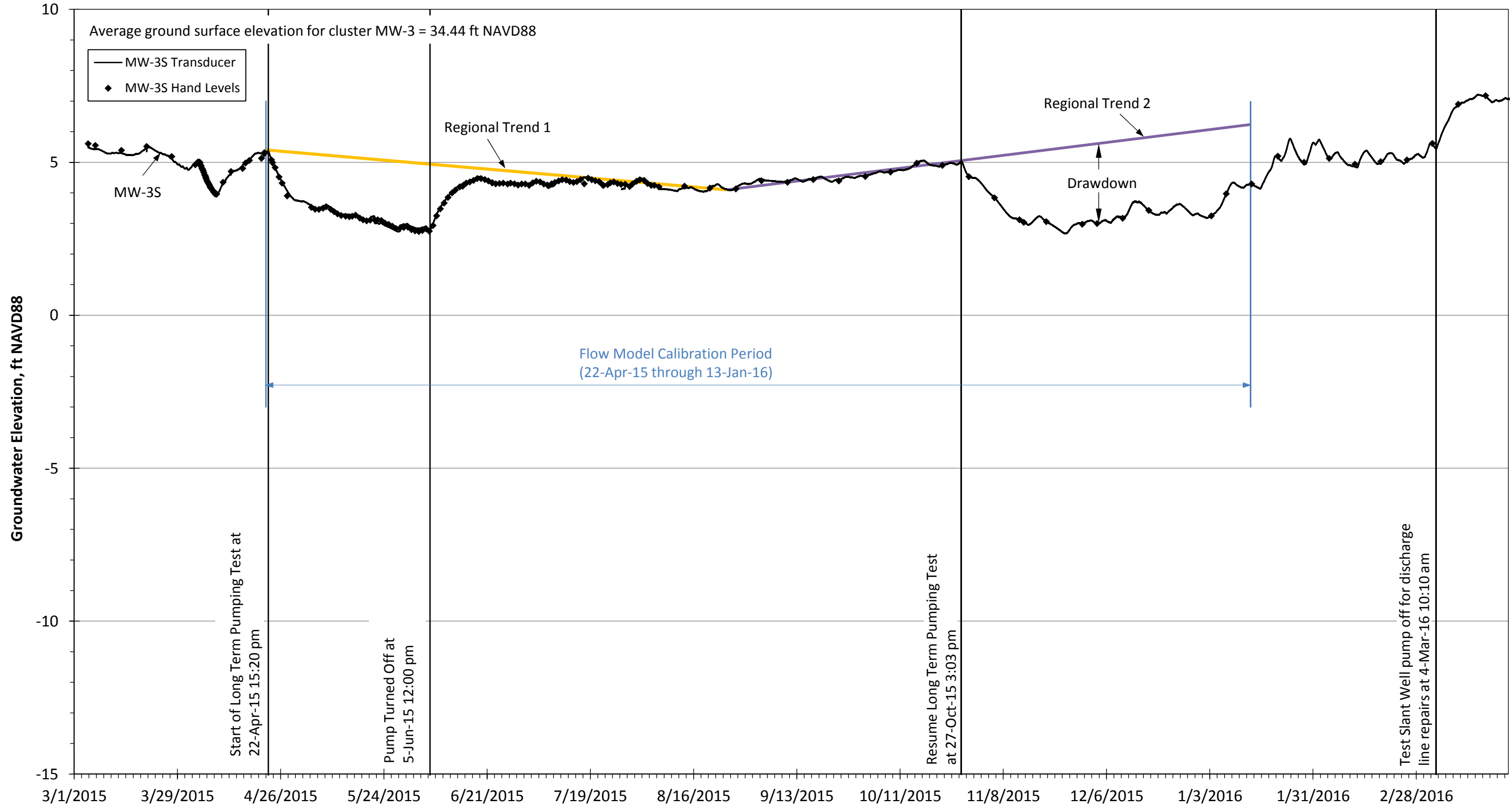


Figure 31

Drawdown Calculation for MW-3M

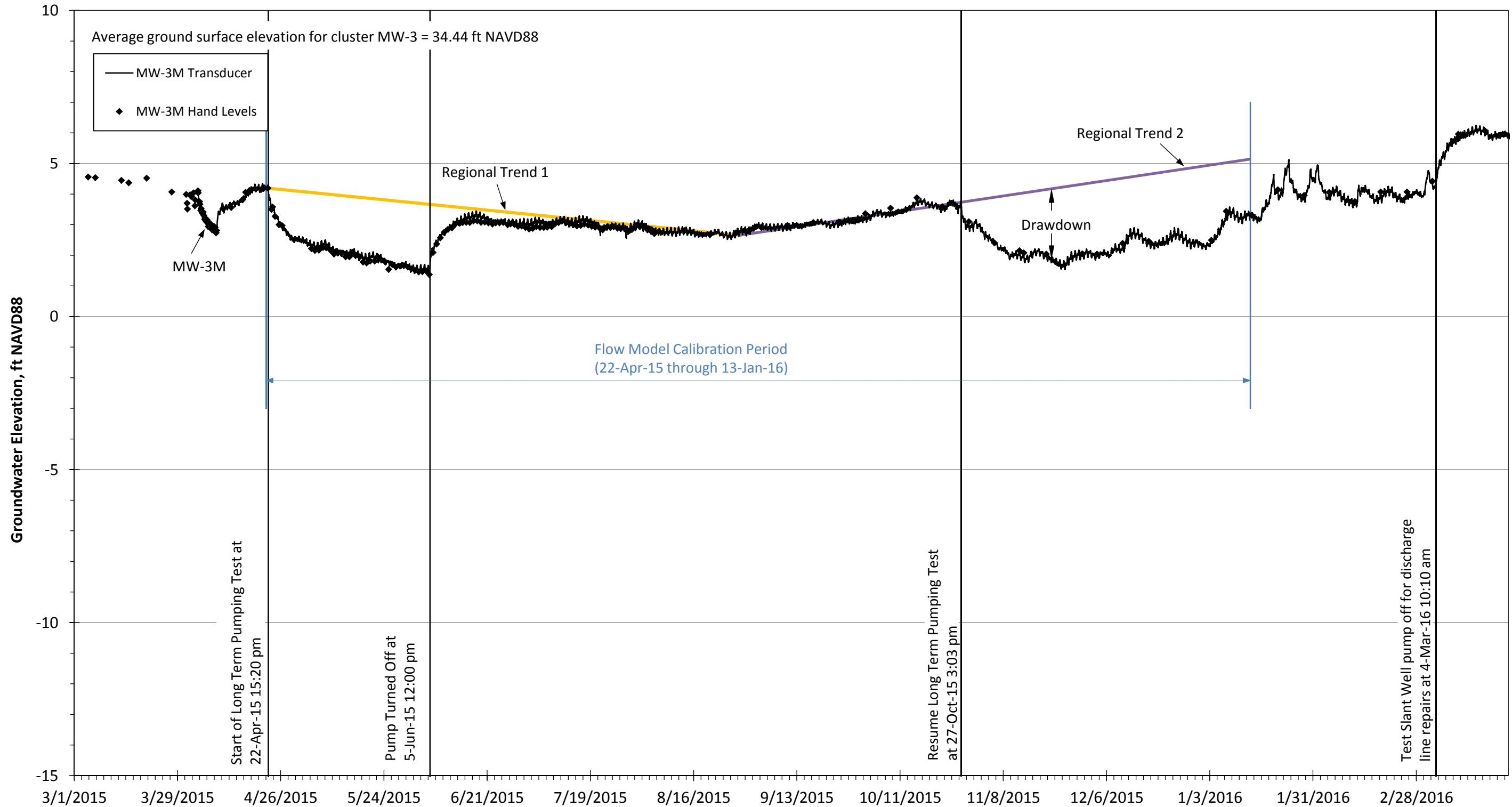


Figure 32

Drawdown Calculation for MW-4S

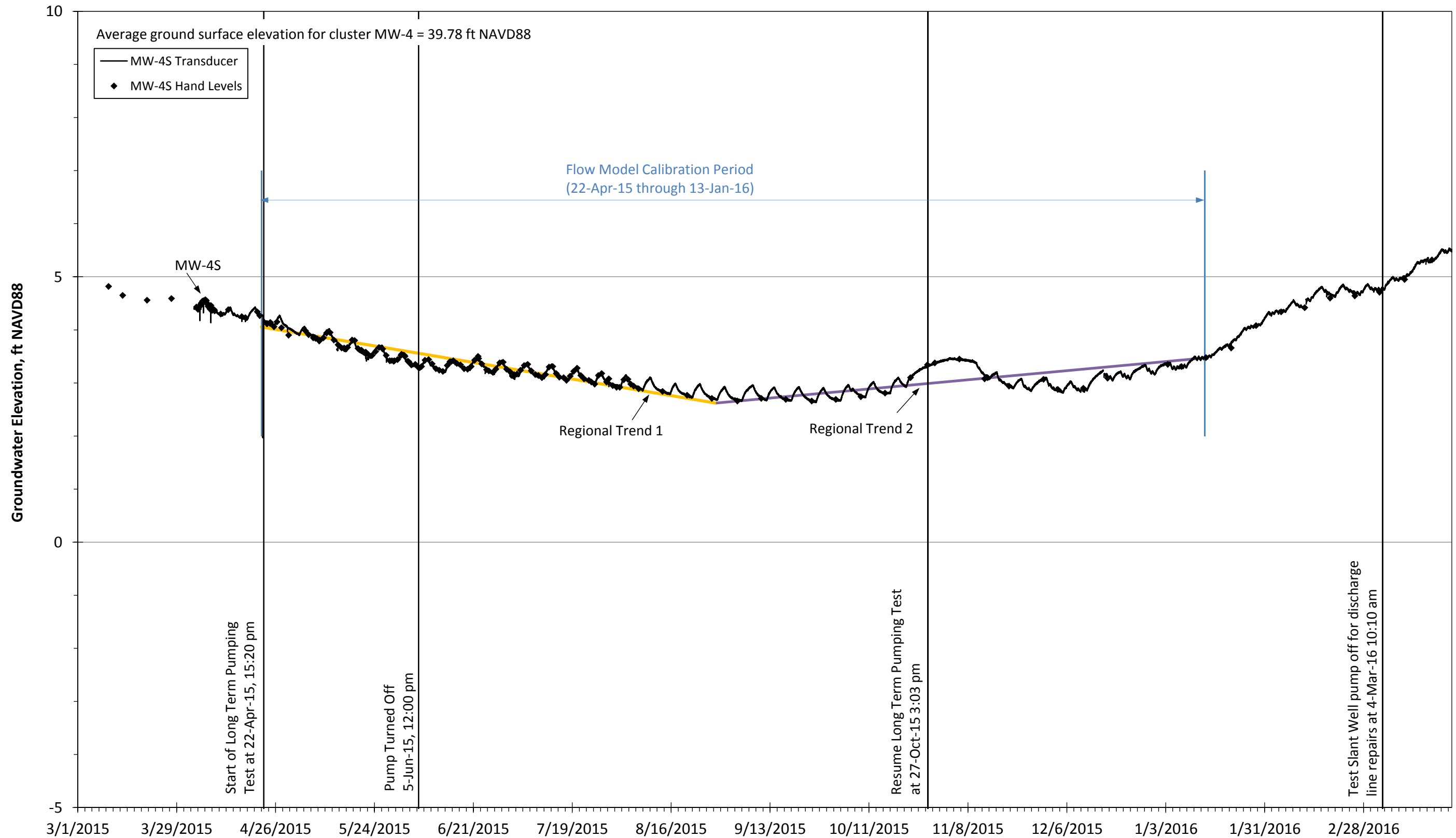


Figure 33

Drawdown Calculation for MW-4M

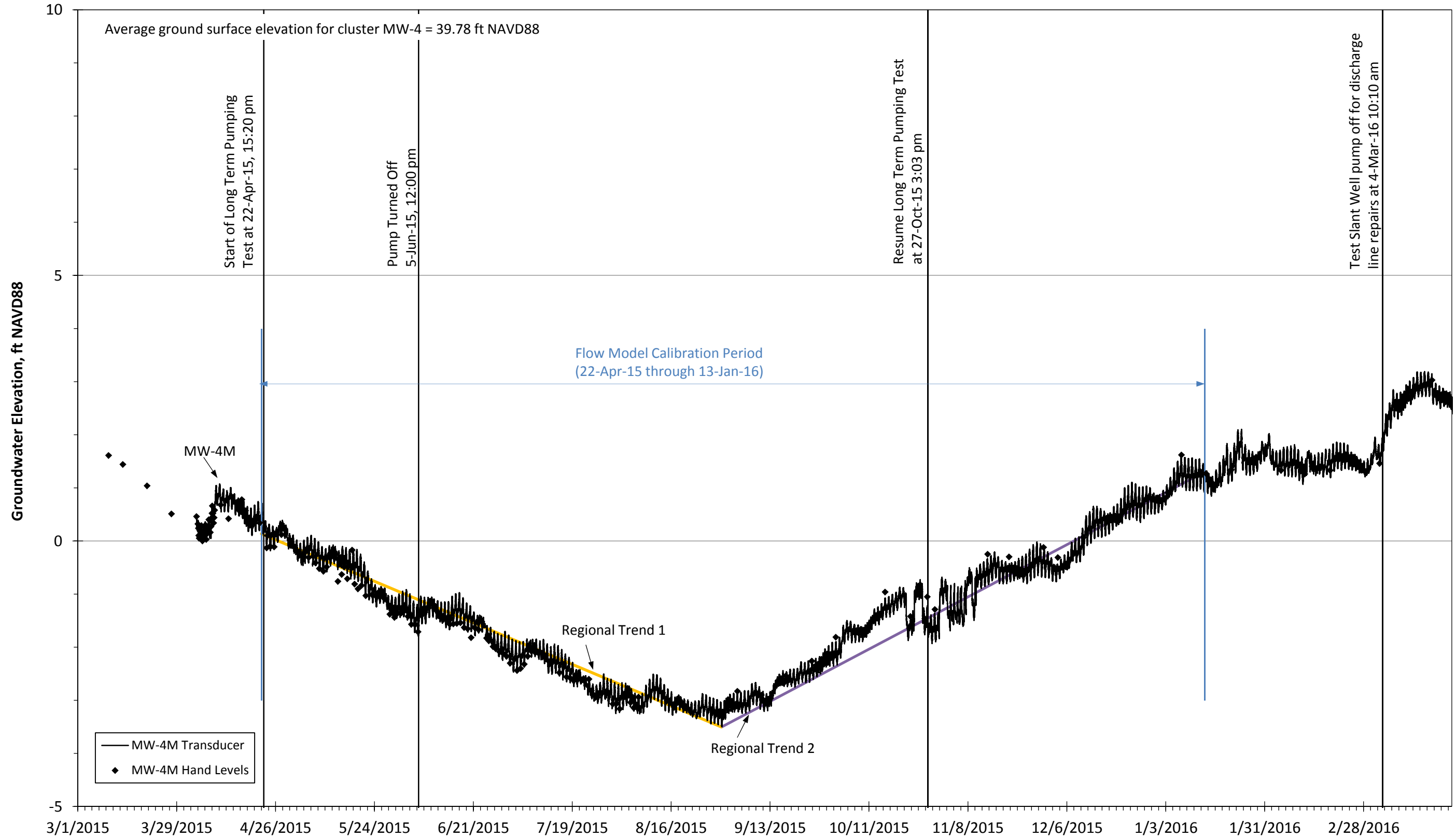


Figure 34

Drawdown Calculation for MW-7S

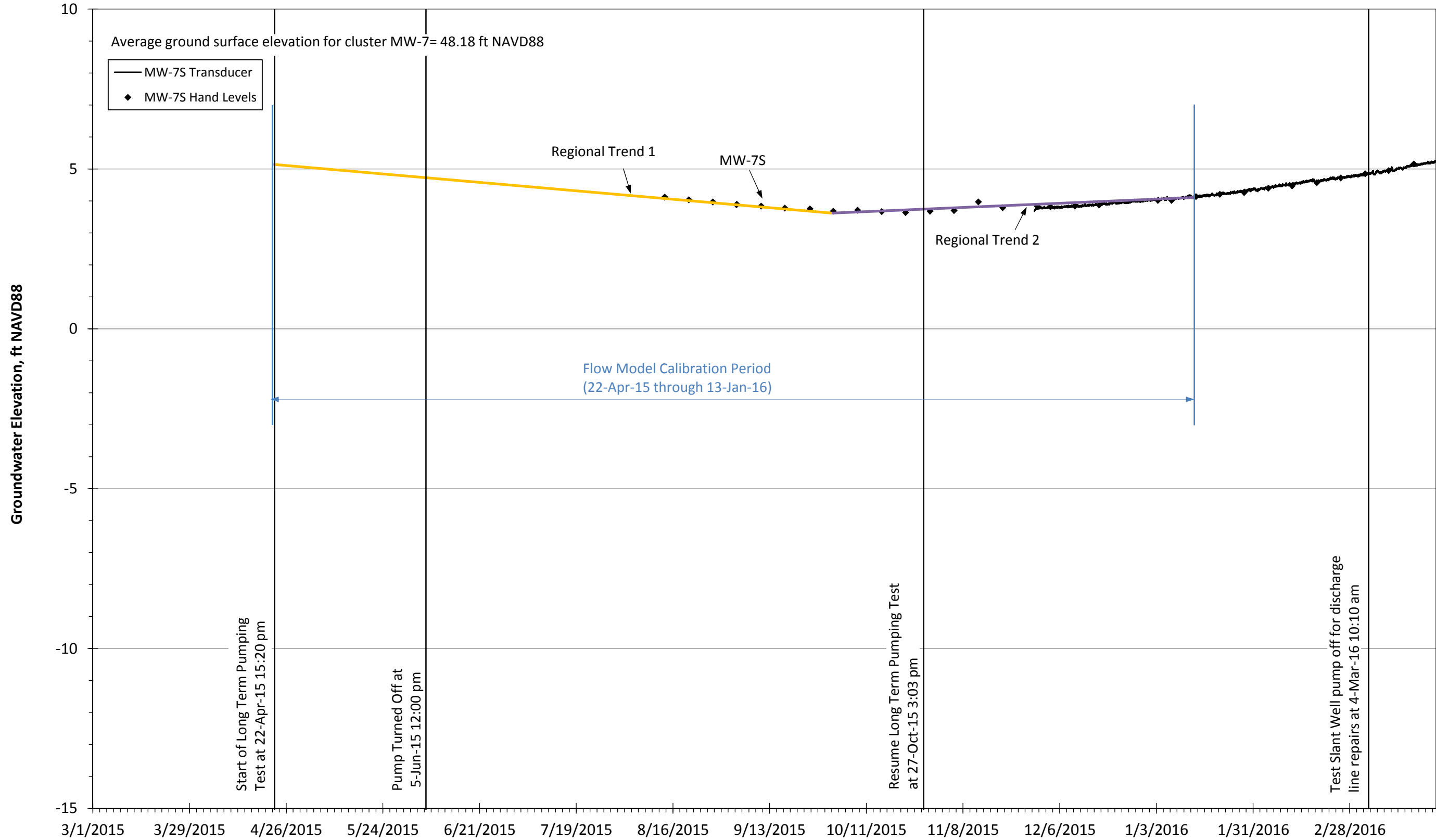


Figure 35

Drawdown Calculation for MW-7M

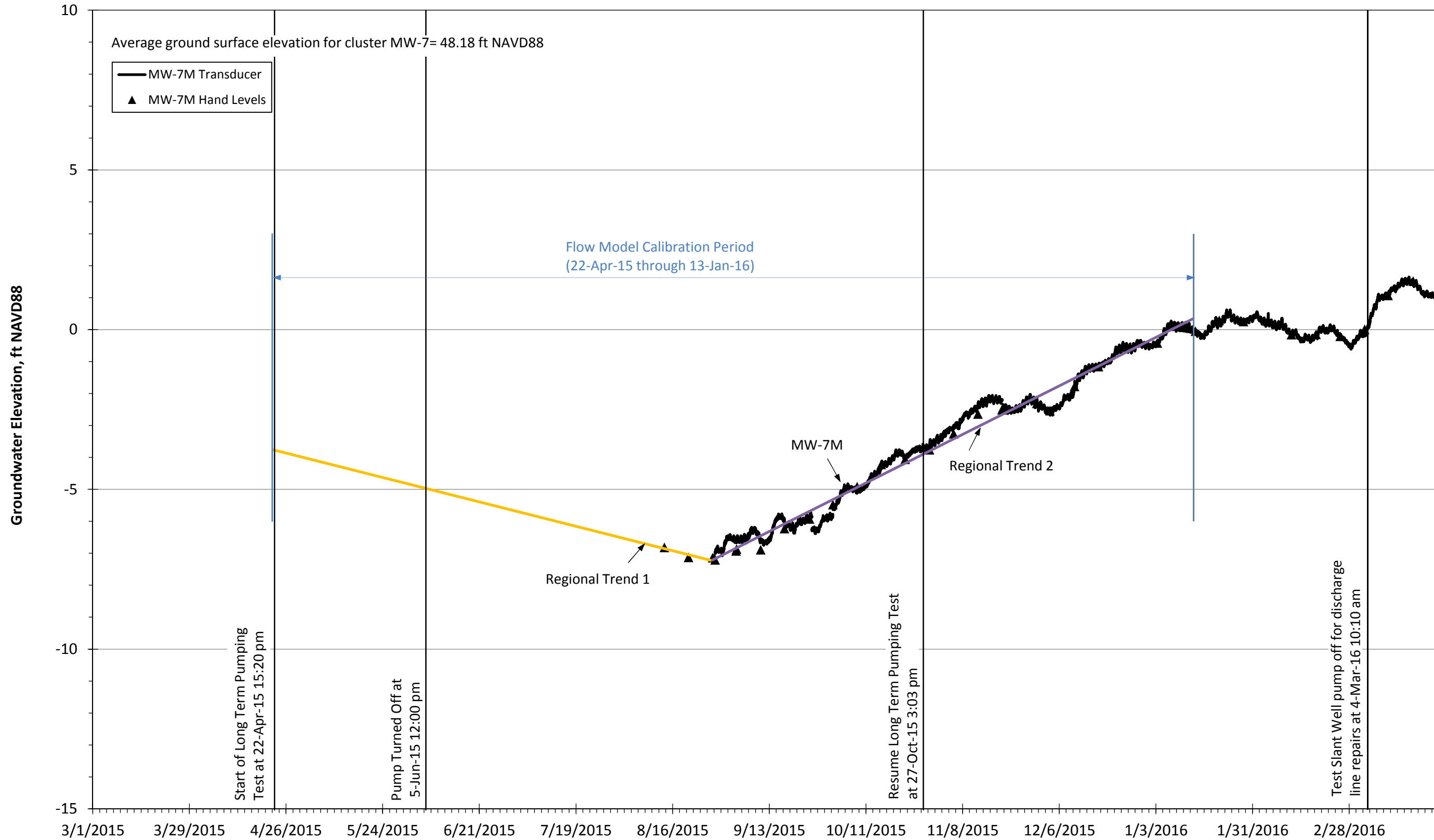
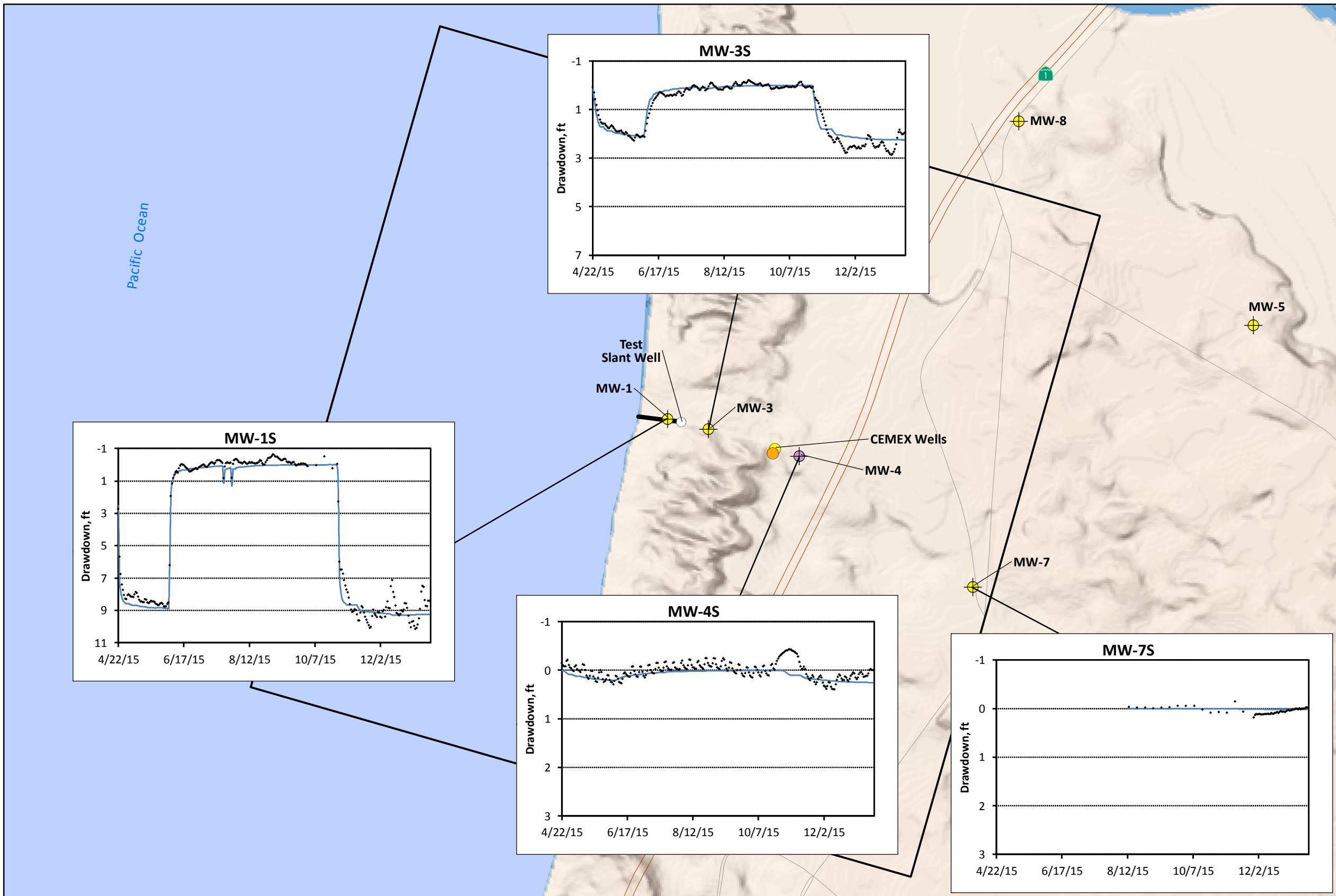


Figure 36

**TRANSIENT CALIBRATION
HYDROGRAPHS OF
SELECTED WELLS
DUNE SAND AQUIFER**

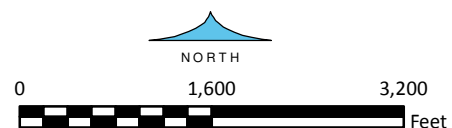


- EXPLANATION**
- CEMEX Model Boundary
 - Monitoring Well Cluster
 - Compliance Monitoring Well Cluster
 - CEMEX Well - Inactive (Monitored)
 - CEMEX Well - Active (Not Monitored)
 - Test Slant Well
 - Drawdown Calculated from Water Level Measurement
 - Model-Calculated Drawdown

8-Feb-17

Prepared by: DB. Map Projection: State Plane 1983, Zone IV.

© 2017, GEOSCIENCE Support Services, Inc. All rights reserved.

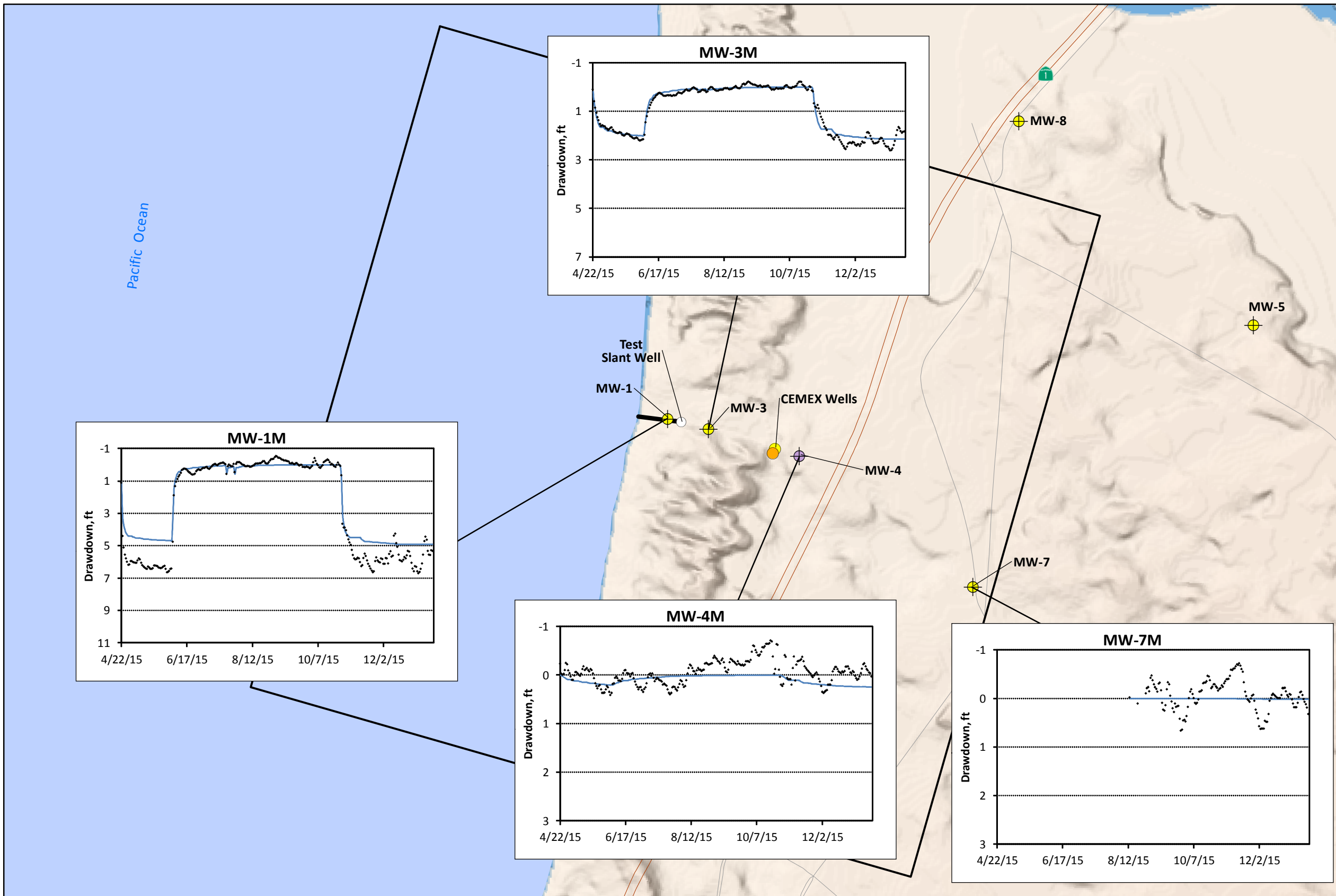


GEOSCIENCE

GEOSCIENCE Support Services, Inc.
P.O. Box 220, Claremont, CA 91711
Tel: (909) 451-6650 Fax: (909) 451-6638
www.gssiwater.com

Figure 37

**TRANSIENT CALIBRATION
HYDROGRAPHS OF
SELECTED WELLS
180-FTE AQUIFER**

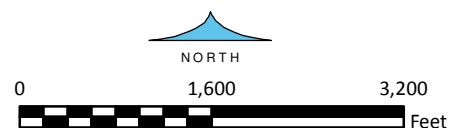


- EXPLANATION**
- CEMEX Model Boundary
 - Monitoring Well Cluster
 - Compliance Monitoring Well Cluster
 - CEMEX Well - Inactive (Monitored)
 - CEMEX Well - Active (Not Monitored)
 - Test Slant Well
 - Drawdown Calculated from Water Level Measurement
 - Model-Calculated Drawdown

8-Feb-17

Prepared by: DB. Map Projection: State Plane 1983, Zone IV.

© 2017, GEOSCIENCE Support Services, Inc. All rights reserved.



GEOSCIENCE

GEOSCIENCE Support Services, Inc.
P.O. Box 220, Claremont, CA 91711
Tel: (909) 451-6650 Fax: (909) 451-6638
www.gssiwater.com

Figure 38

Comparison of Measured Versus Model-Calculated Drawdowns Transient Model Calibration (22-Apr-15 through 13-Jan-16) -All Calibration Wells

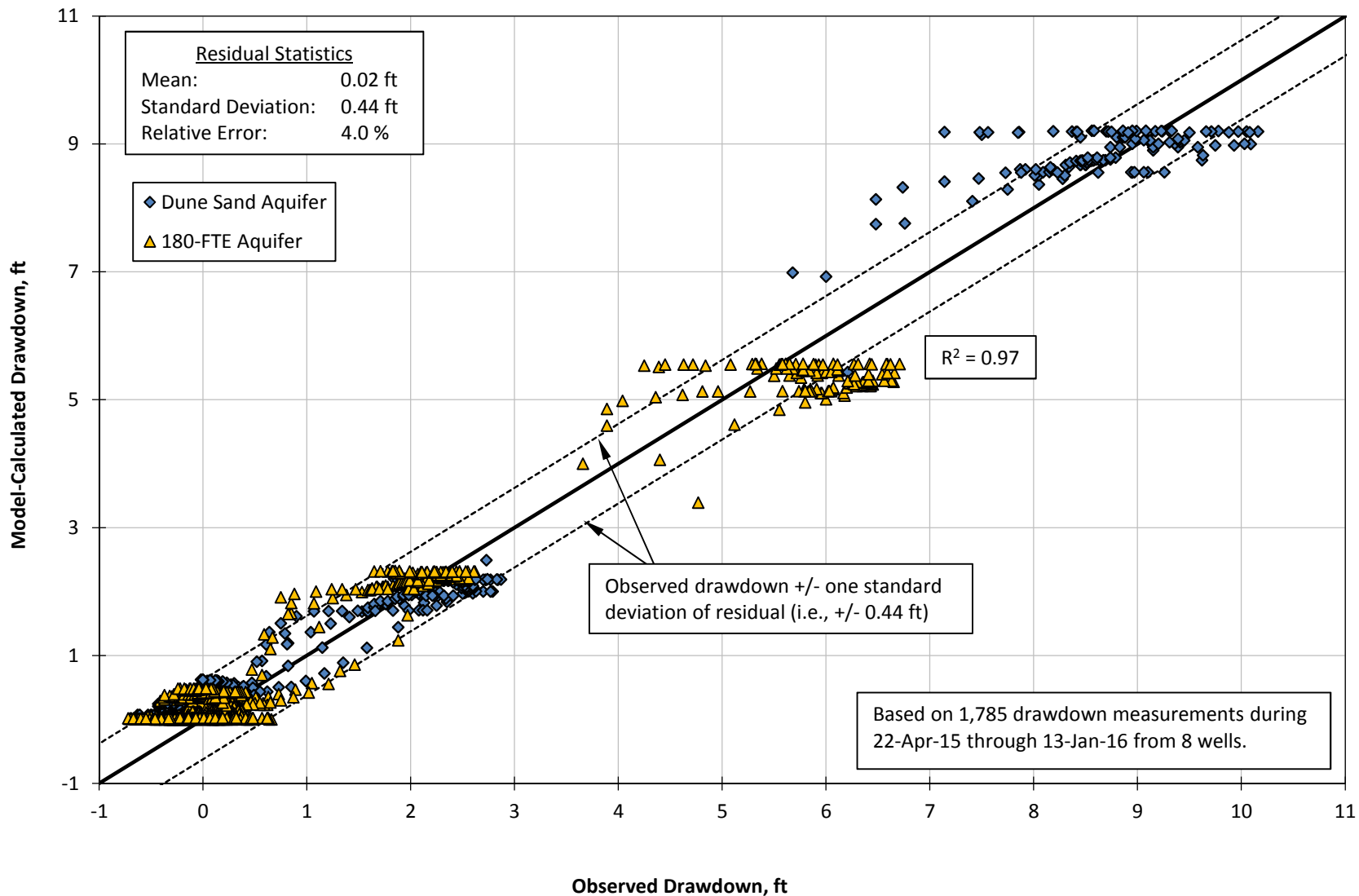


Figure 39

Histogram of Drawdown Residuals Transient Model Calibration (22-Apr-15 through 13-Jan-16) - All Calibration Wells

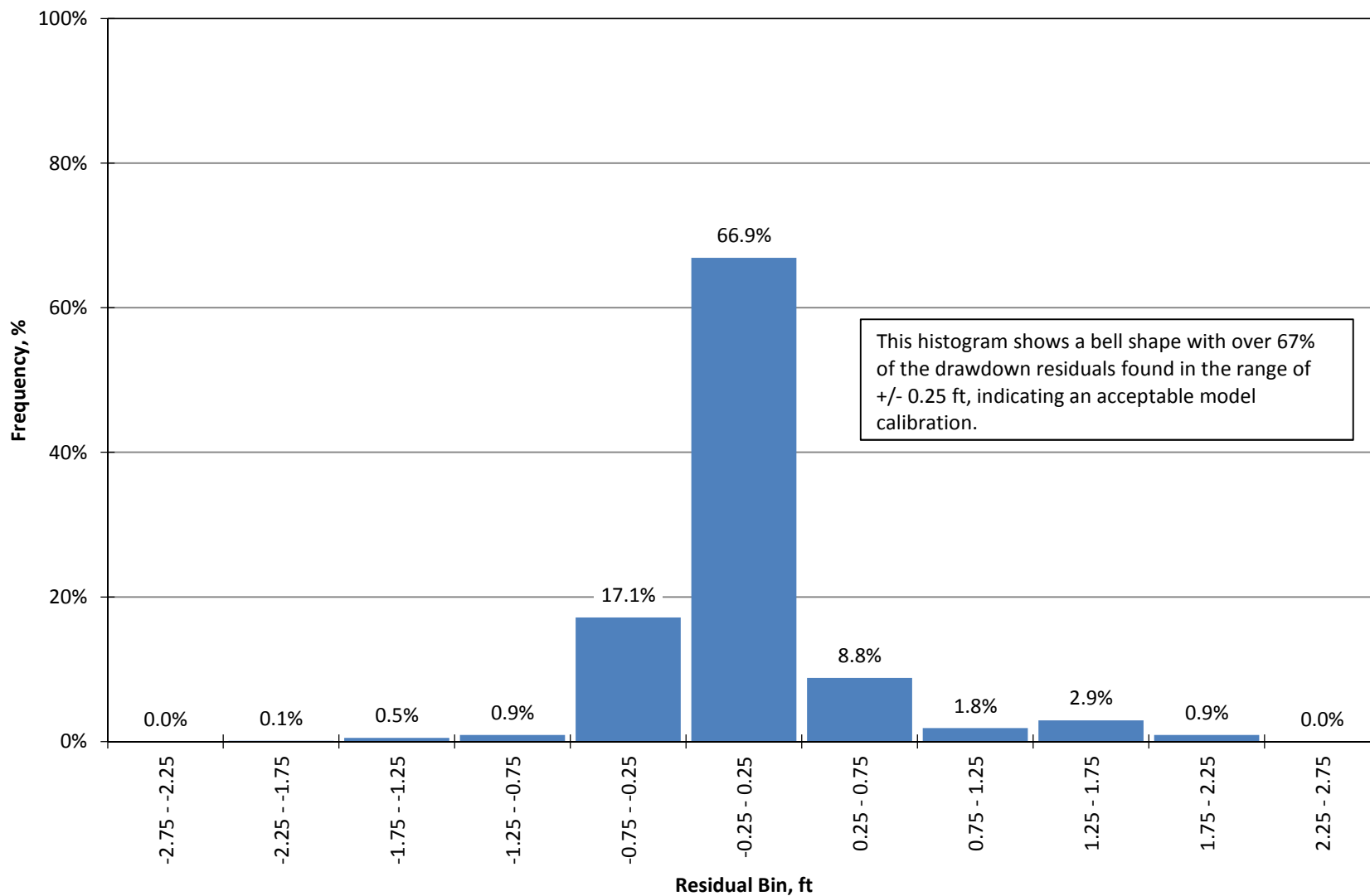


Figure 40

Drawdown Residuals through Time Transient Model Calibration (22-Apr-15 through 13-Jan-16) - All Calibration Wells

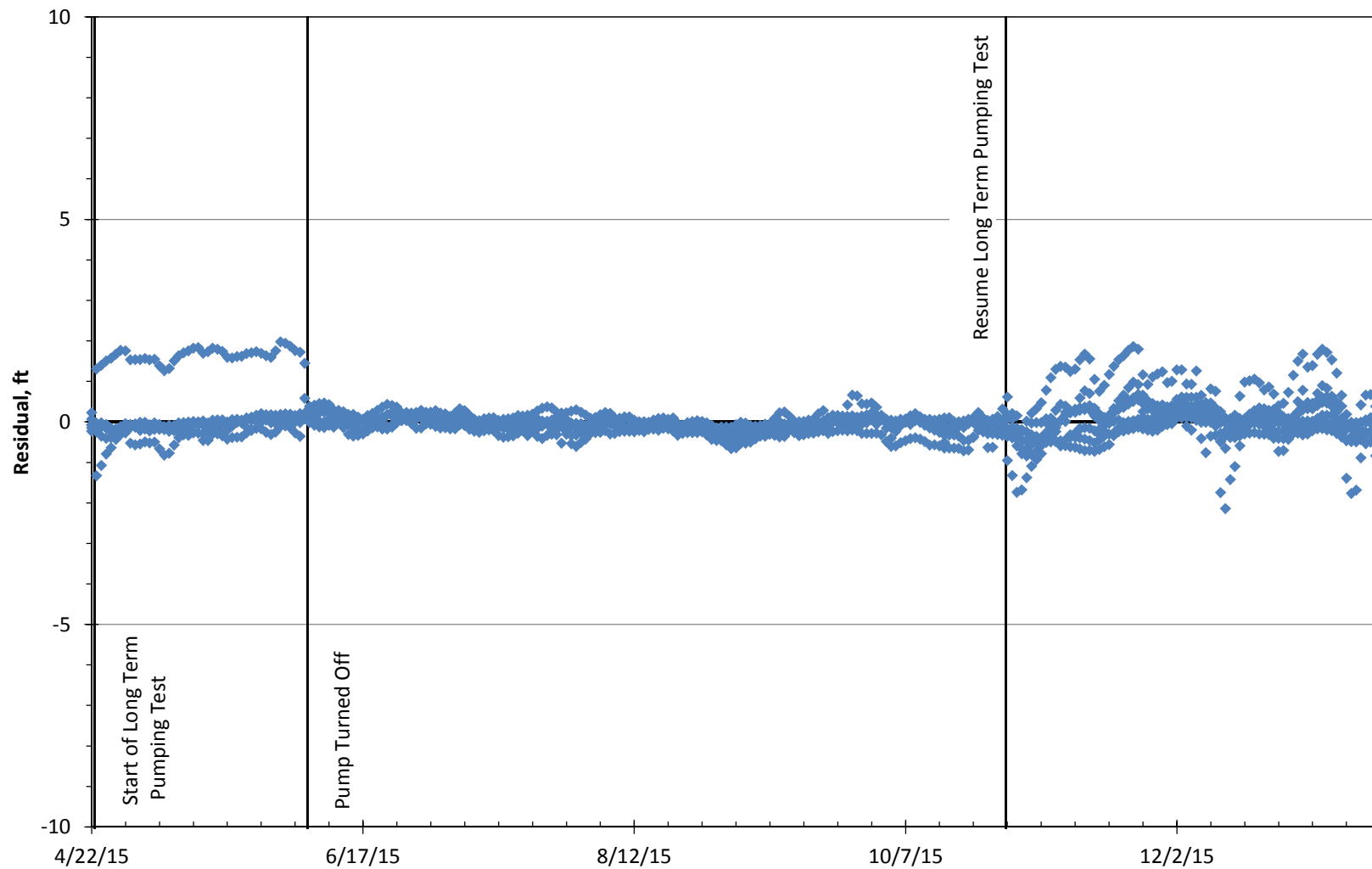


Figure 41

Comparison of Measured Versus Model-Calculated Drawdowns Transient Modeal Calibriation (22-Apr-15 through 13-Jan-16) -MW-15

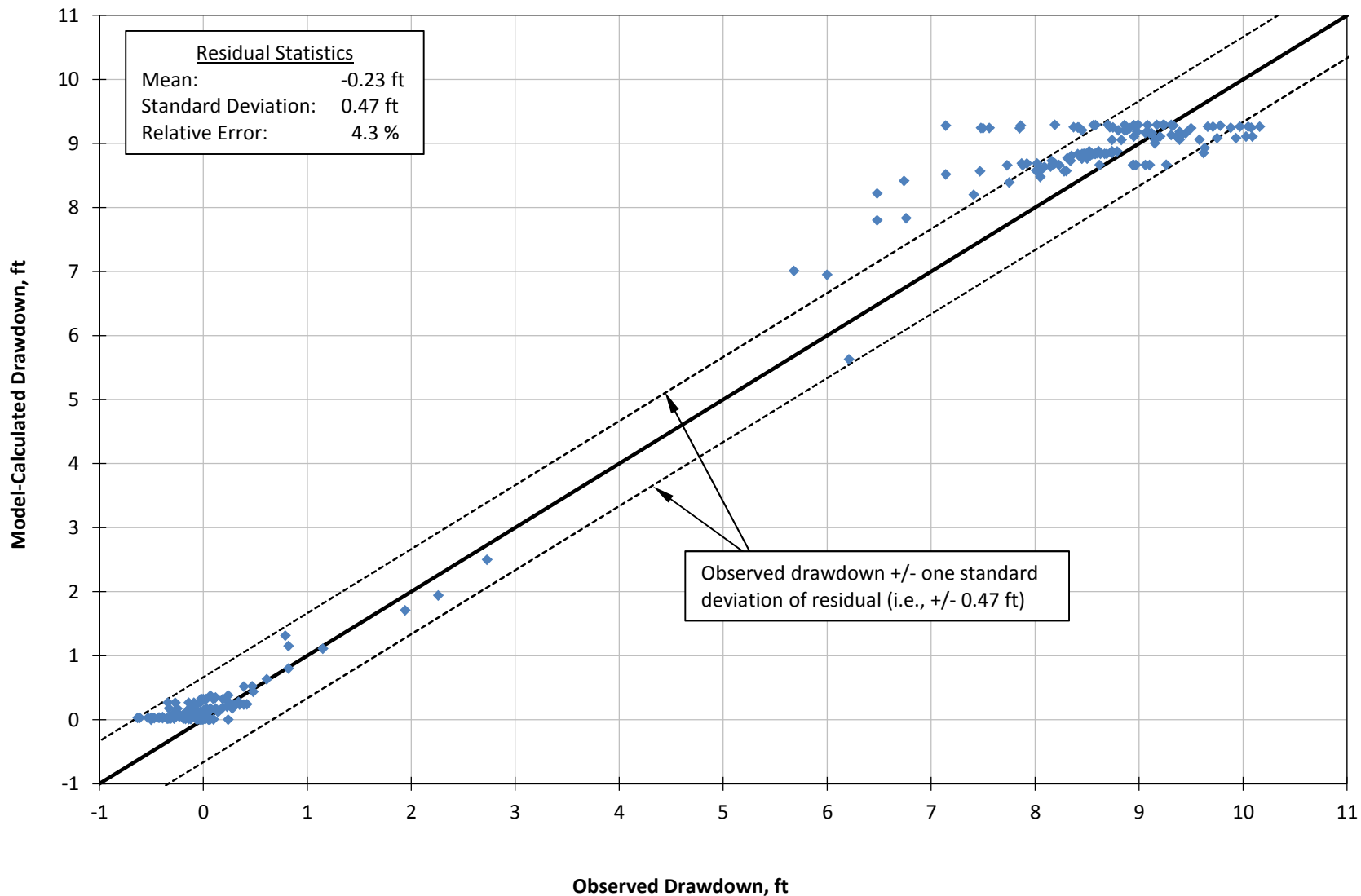


Figure 42

Comparison of Measured Versus Model-Calculated Drawdowns Transient Model Calibration (22-Apr-15 through 13-Jan-16) -MW-1M

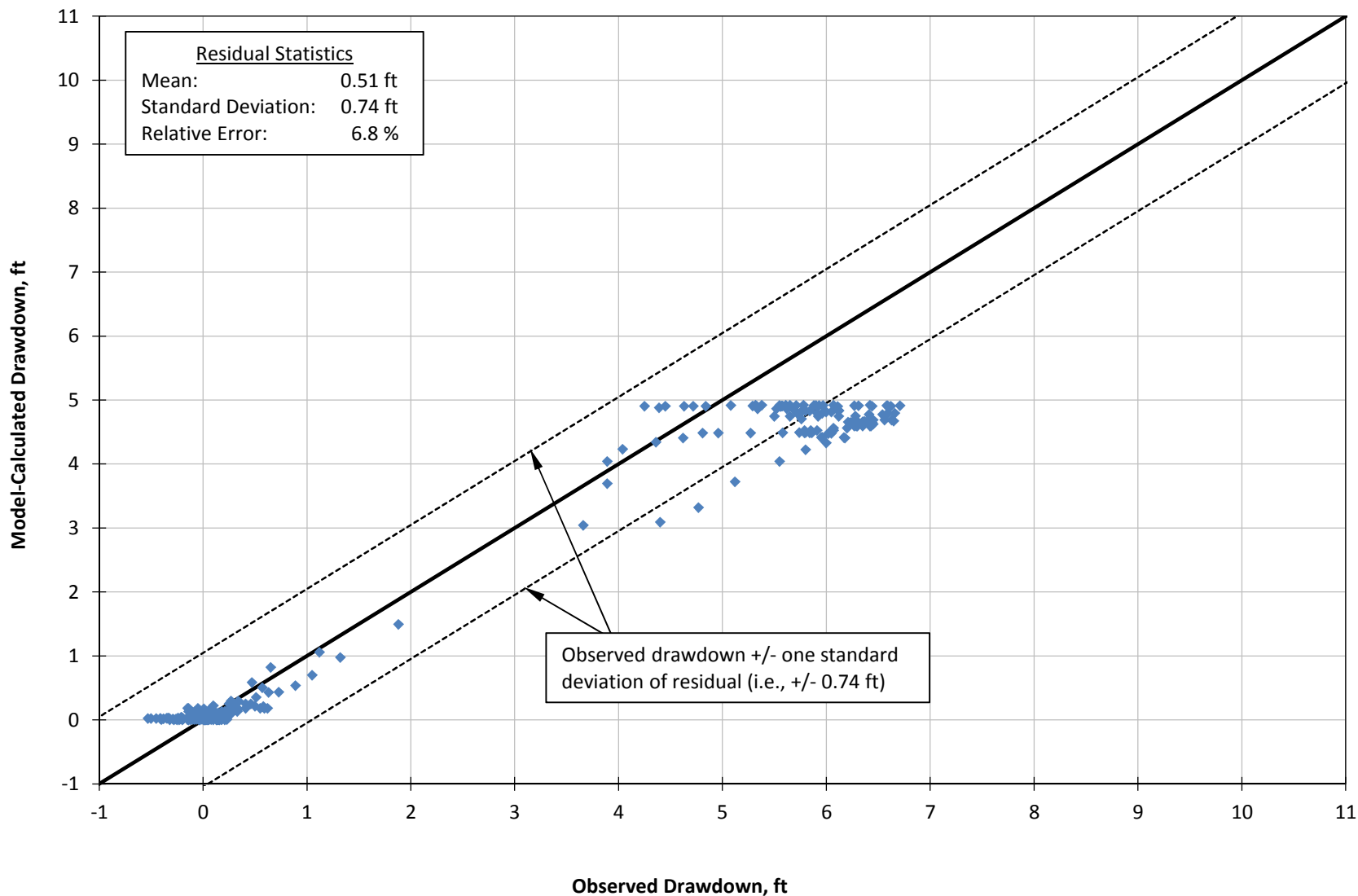


Figure 43

Comparison of Measured Versus Model-Calculated Drawdowns
Transient Modeal Calibriation (22-Apr-15 through 13-Jan-16) -MW-3S

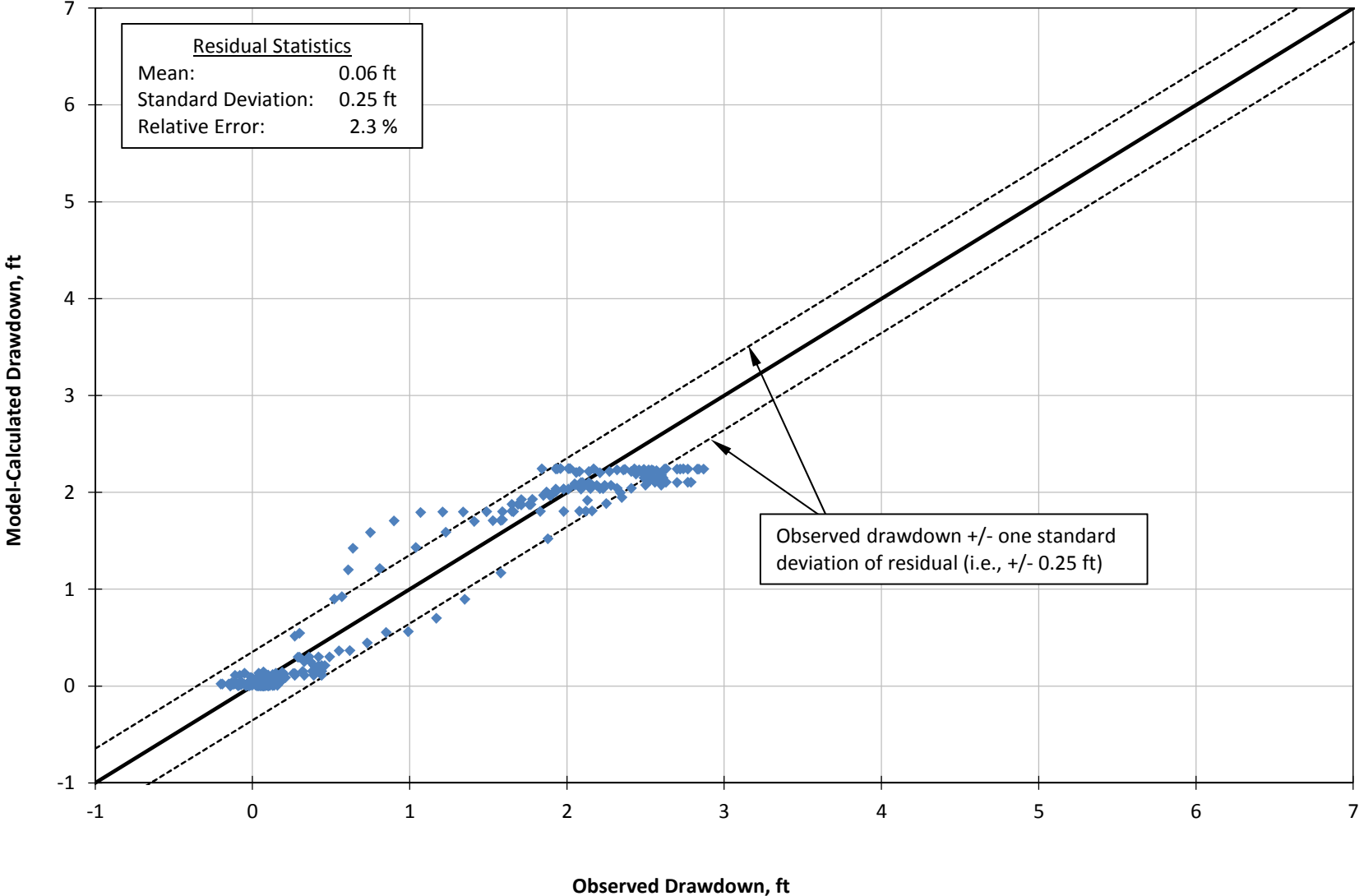


Figure 44

Comparison of Measured Versus Model-Calculated Drawdowns
Transient Model Calibration (22-Apr-15 through 13-Jan-16) -MW-3M

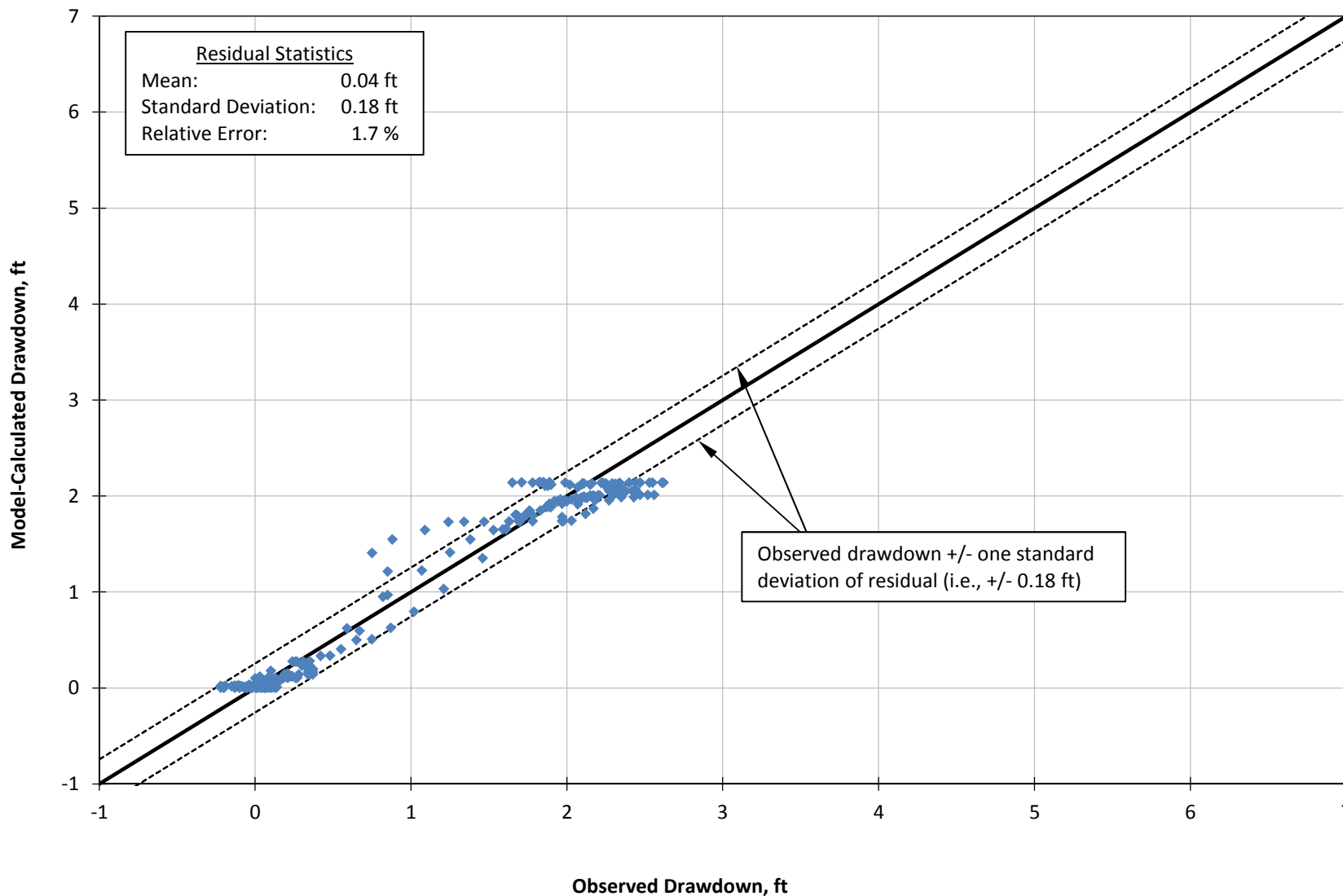


Figure 45

Comparison of Measured Versus Model-Calculated Drawdowns
Transient Modeal Calibriation (22-Apr-15 through 13-Jan-16) -MW-4S

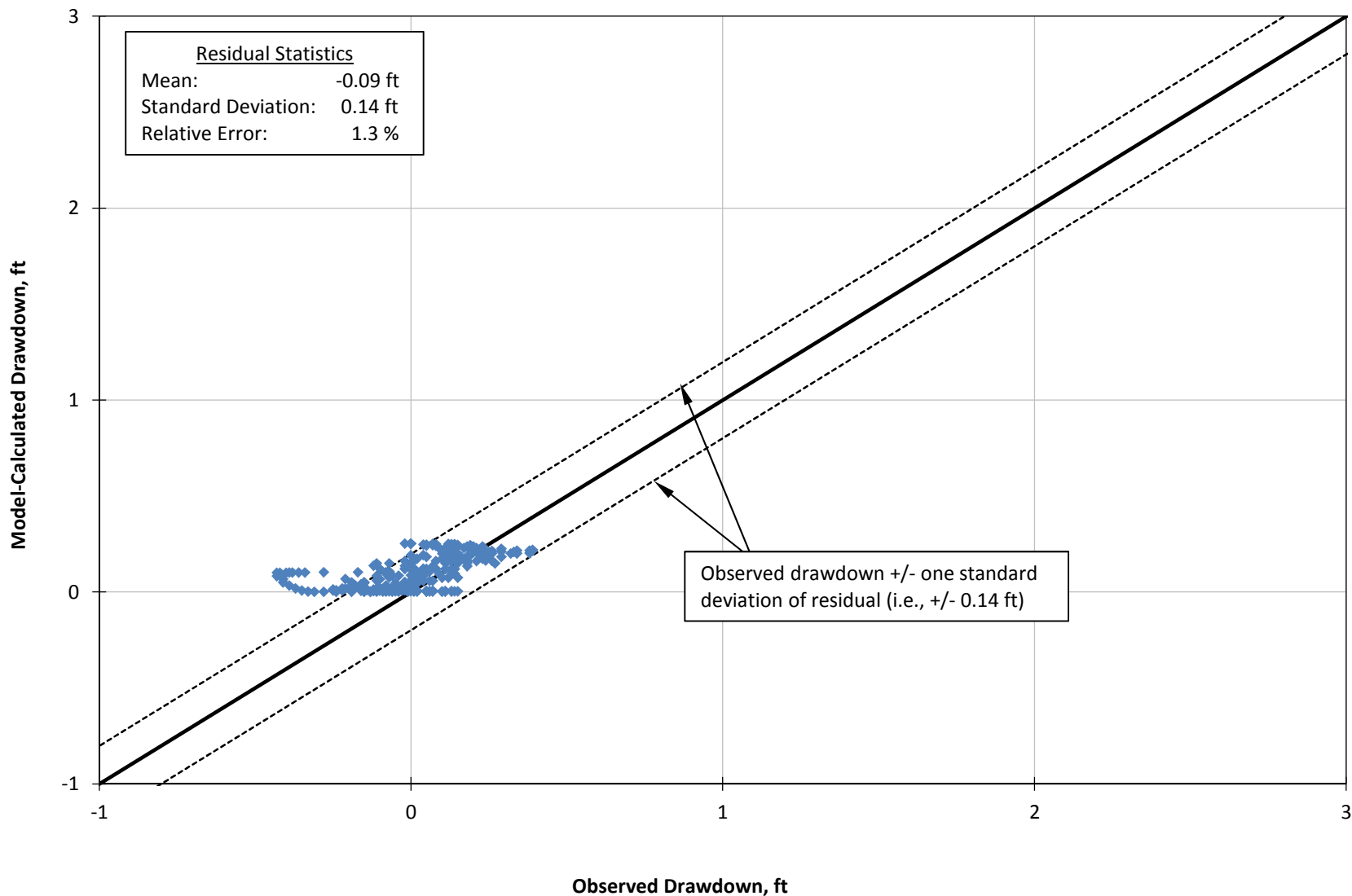


Figure 46

Comparison of Measured Versus Model-Calculated Drawdowns Transient Model Calibration (22-Apr-15 through 13-Jan-16) -MW-4M

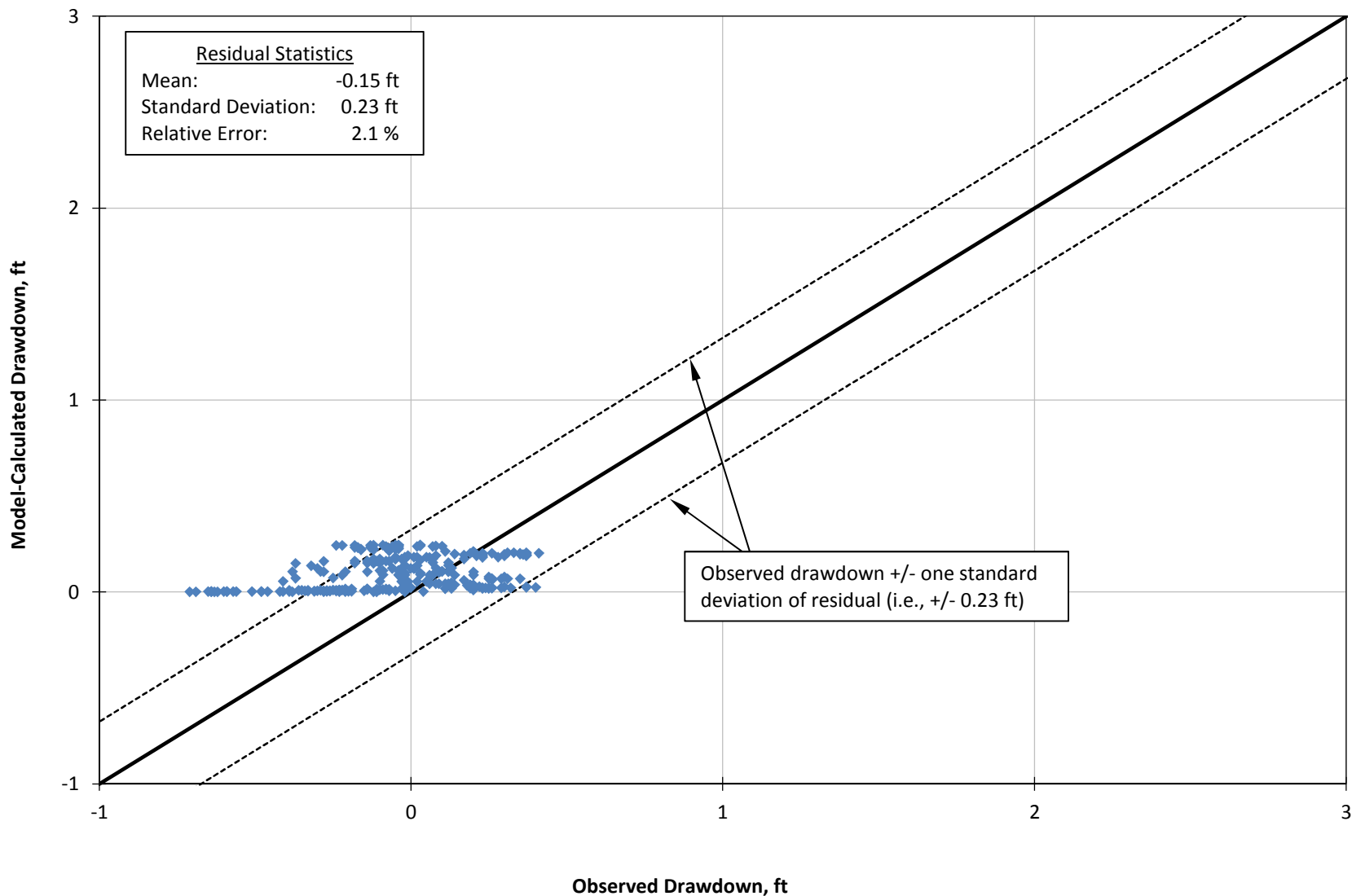


Figure 47

Comparison of Measured Versus Model-Calculated Drawdowns Transient Modeal Calibriation (22-Apr-15 through 13-Jan-16) -MW-7S

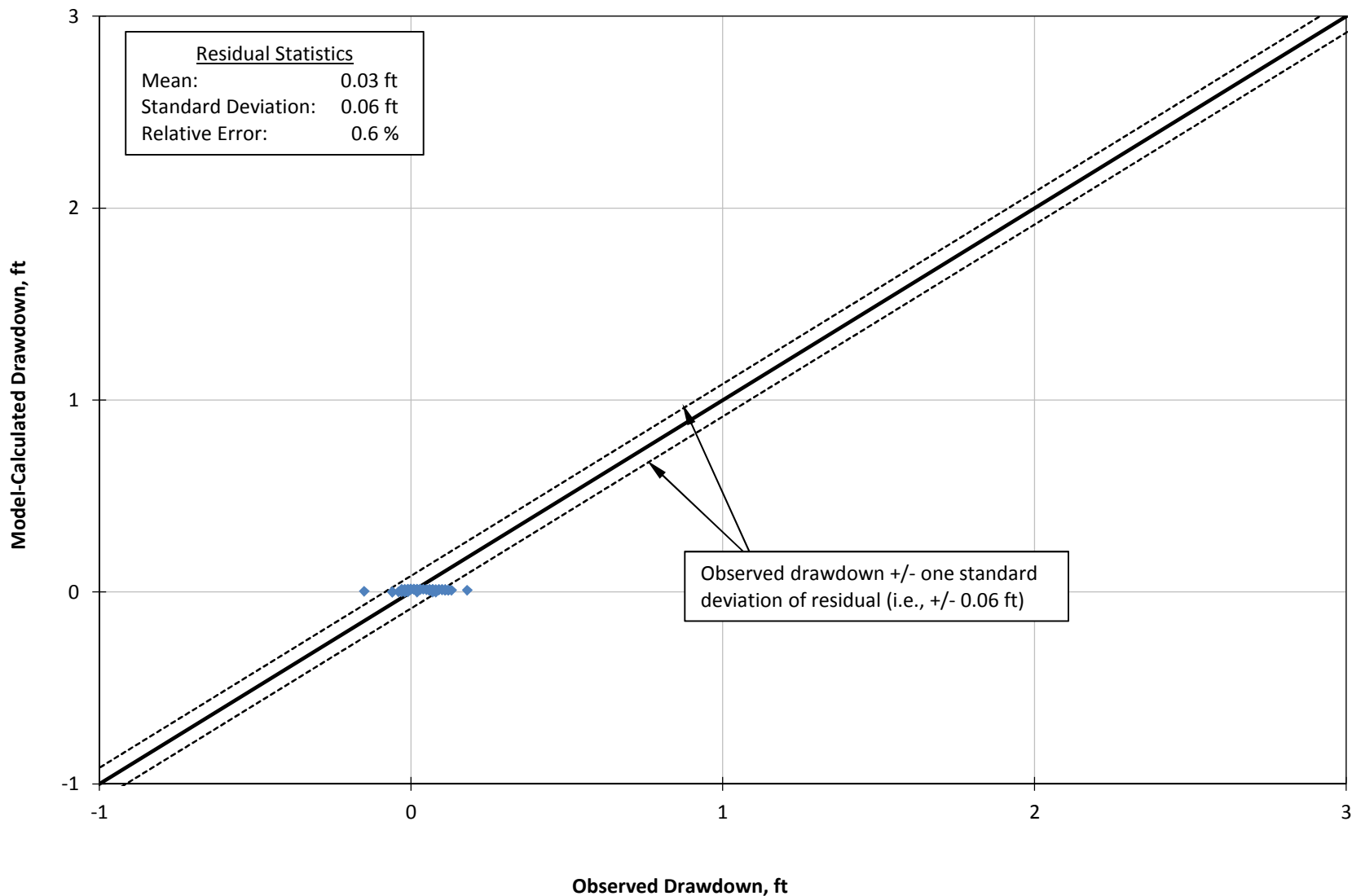


Figure 48

Comparison of Measured Versus Model-Calculated Drawdowns Transient Model Calibration (22-Apr-15 through 13-Jan-16) -MW-7M

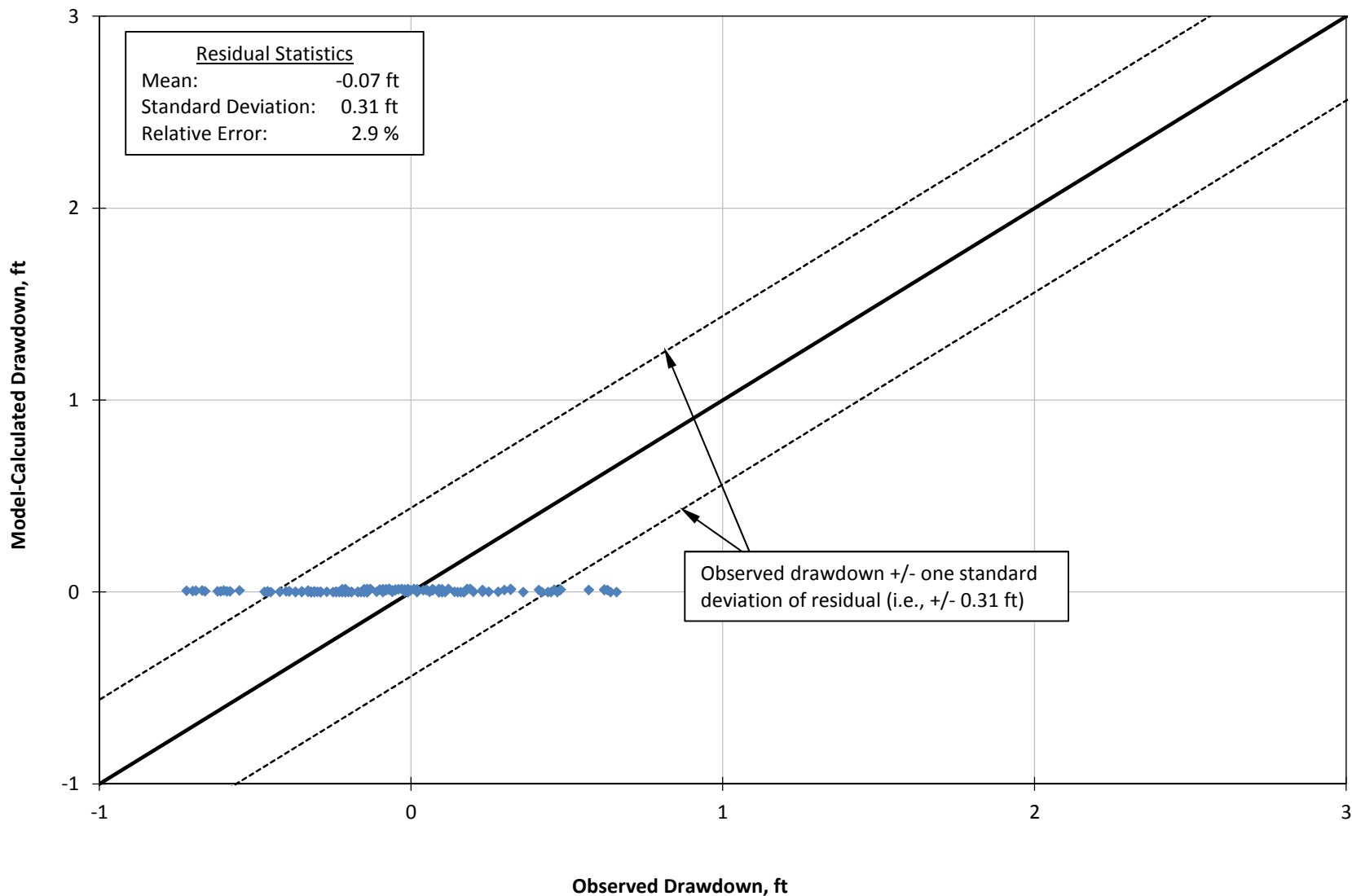


Figure 49

Histogram of Drawdown Residuals
Transient Model Calibration (22-Apr-15 through 13-Jan-16) - MW-1S

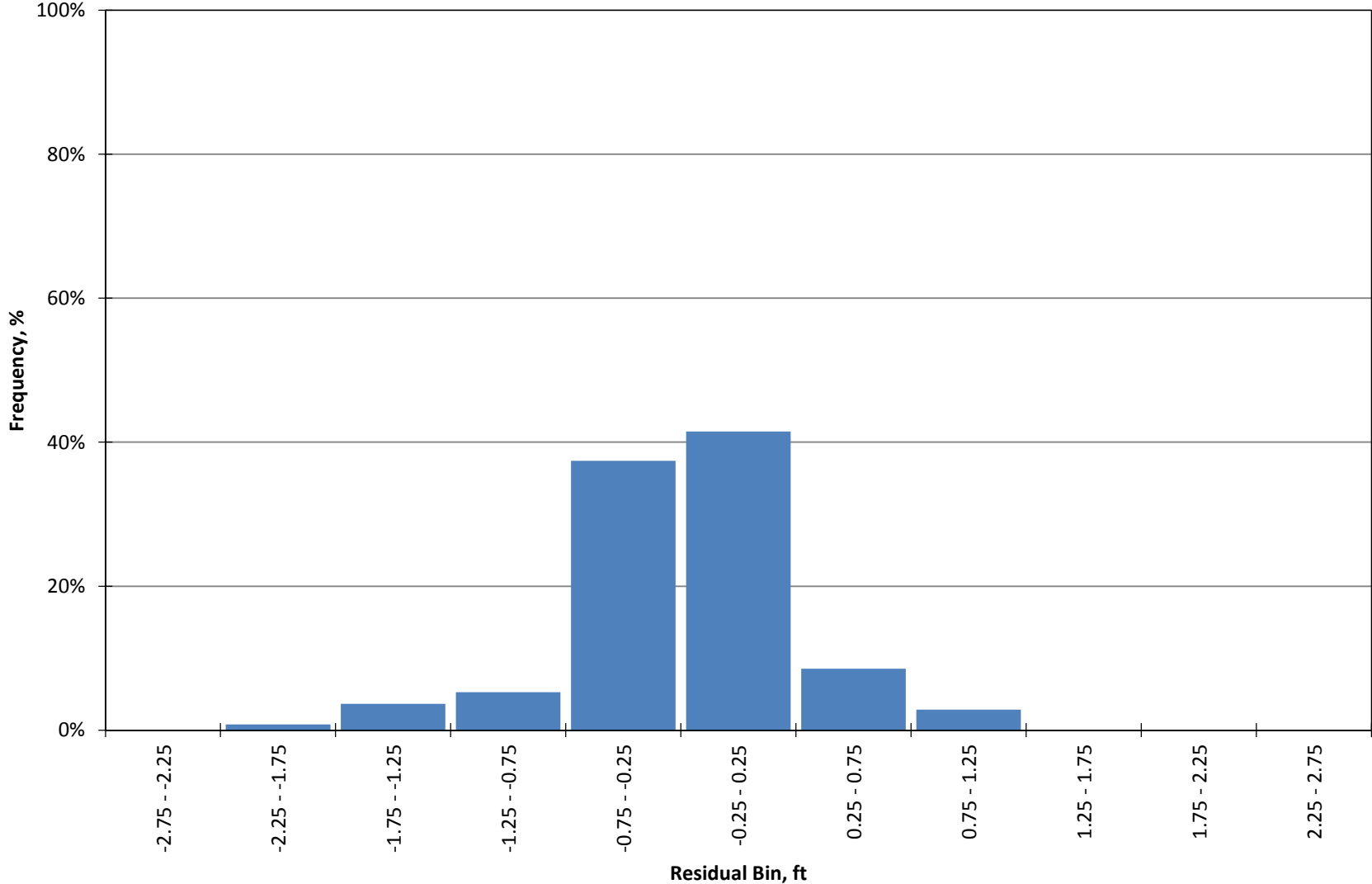


Figure 50

Histogram of Drawdown Residuals Transient Model Calibration (22-Apr-15 through 13-Jan-16) - MW-1M

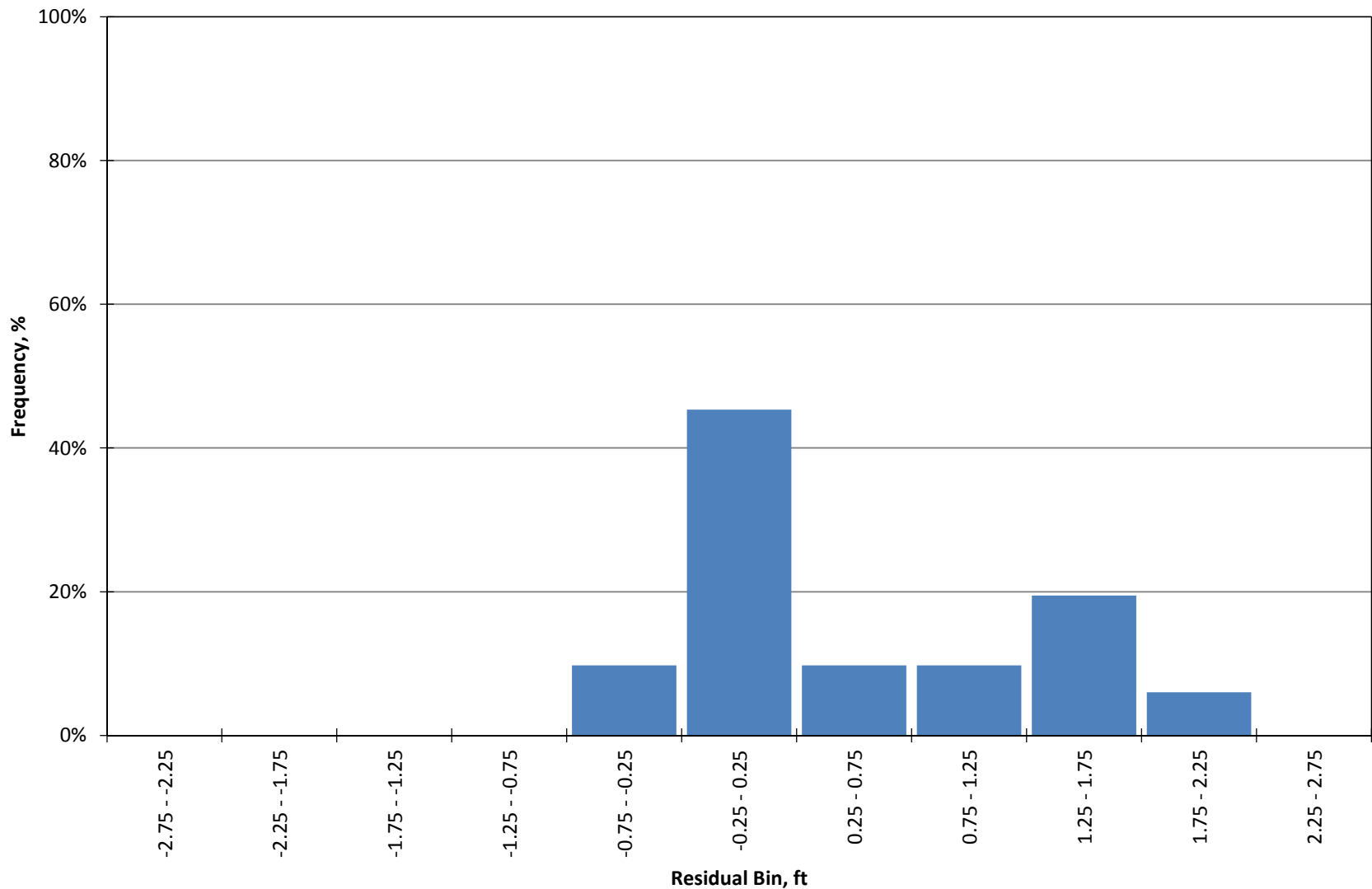


Figure 51

Histogram of Drawdown Residuals
Transient Model Calibration (22-Apr-15 through 13-Jan-16) - MW-3S

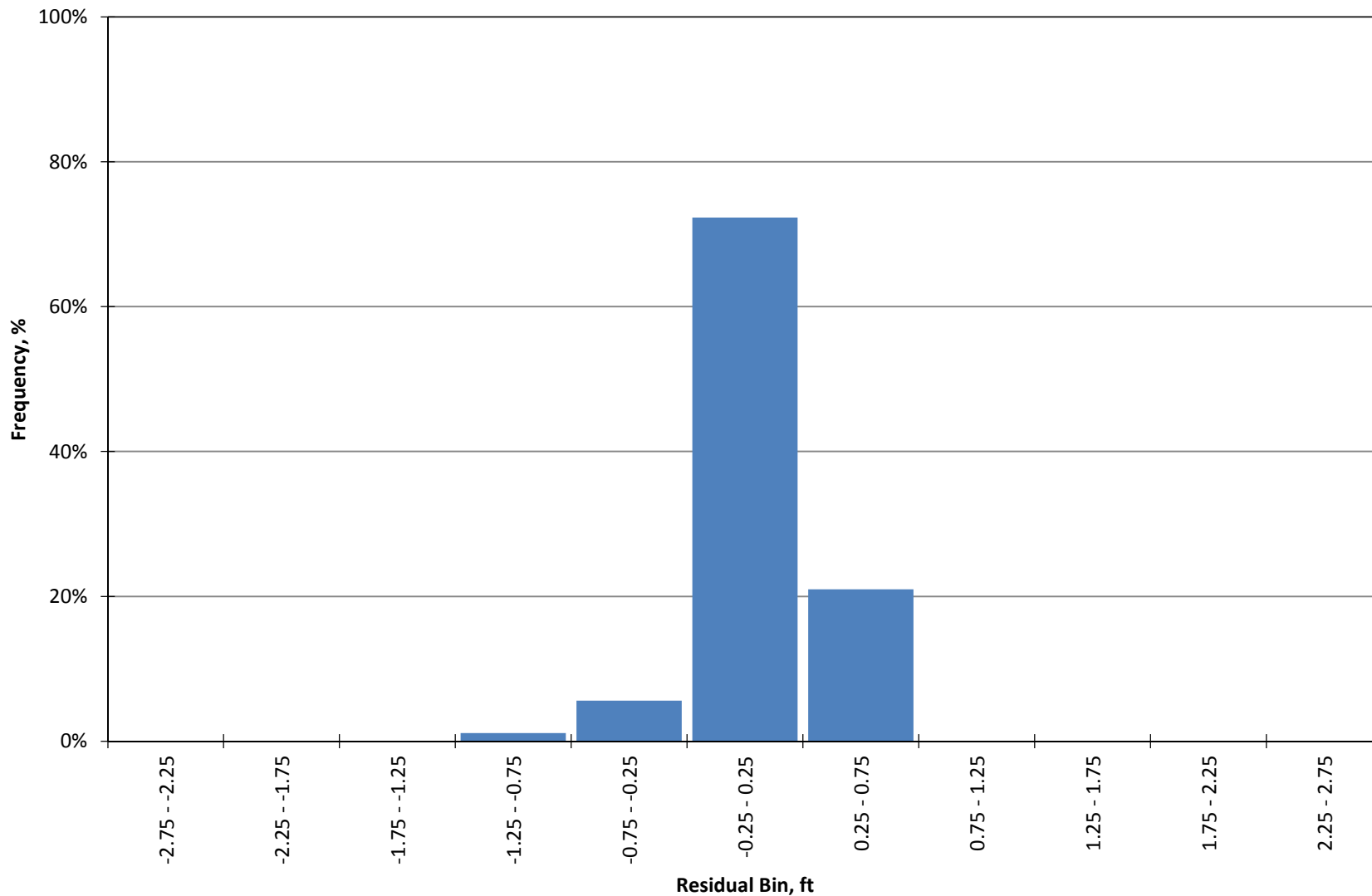


Figure 52

Histogram of Drawdown Residuals Transient Model Calibration (22-Apr-15 through 13-Jan-16) - MW-3M

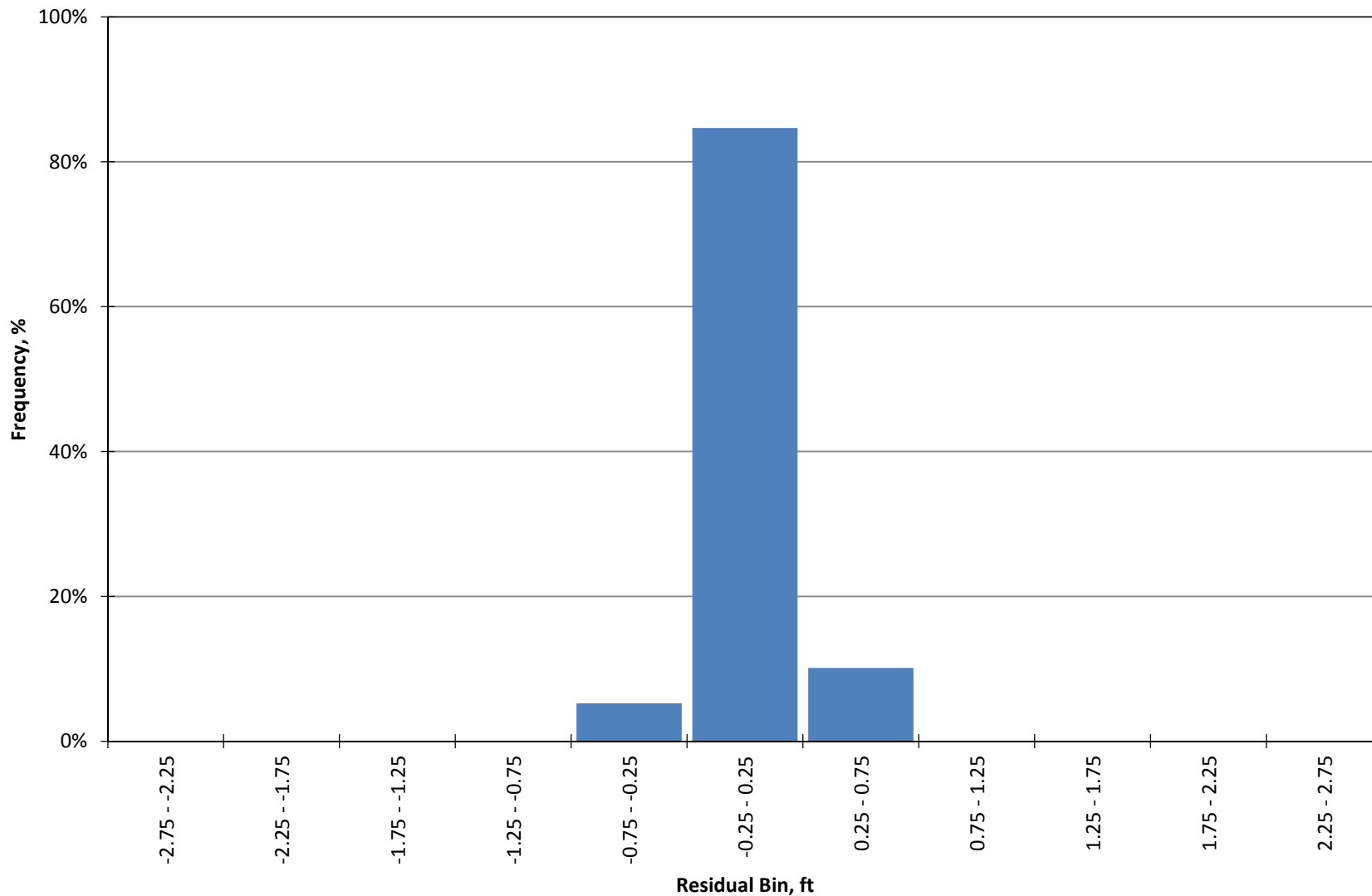


Figure 53

Histogram of Drawdown Residuals Transient Model Calibration (22-Apr-15 through 13-Jan-16) - MW-4S

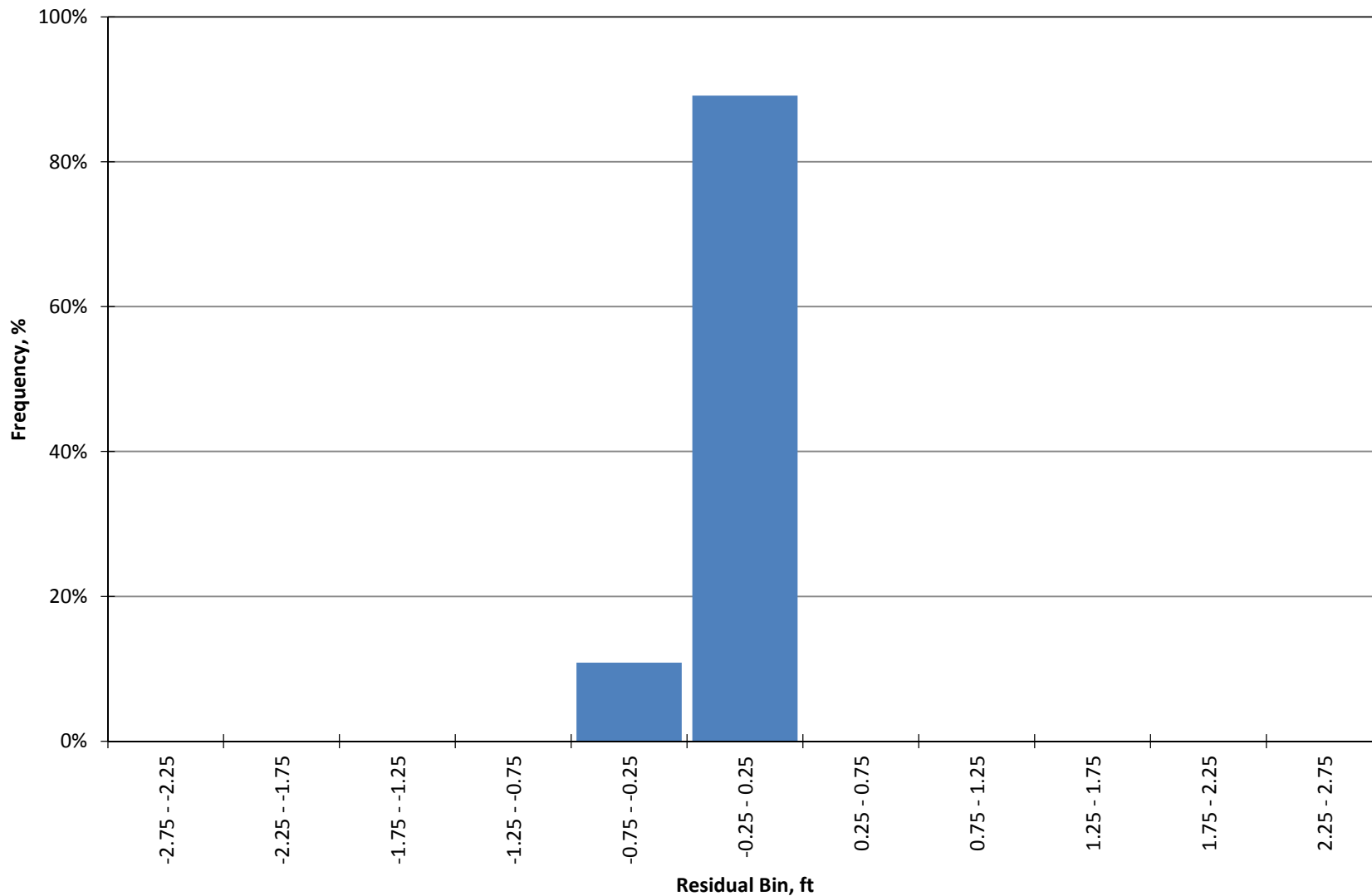


Figure 54

Histogram of Drawdown Residuals
Transient Model Calibration (22-Apr-15 through 13-Jan-16) - MW-4M

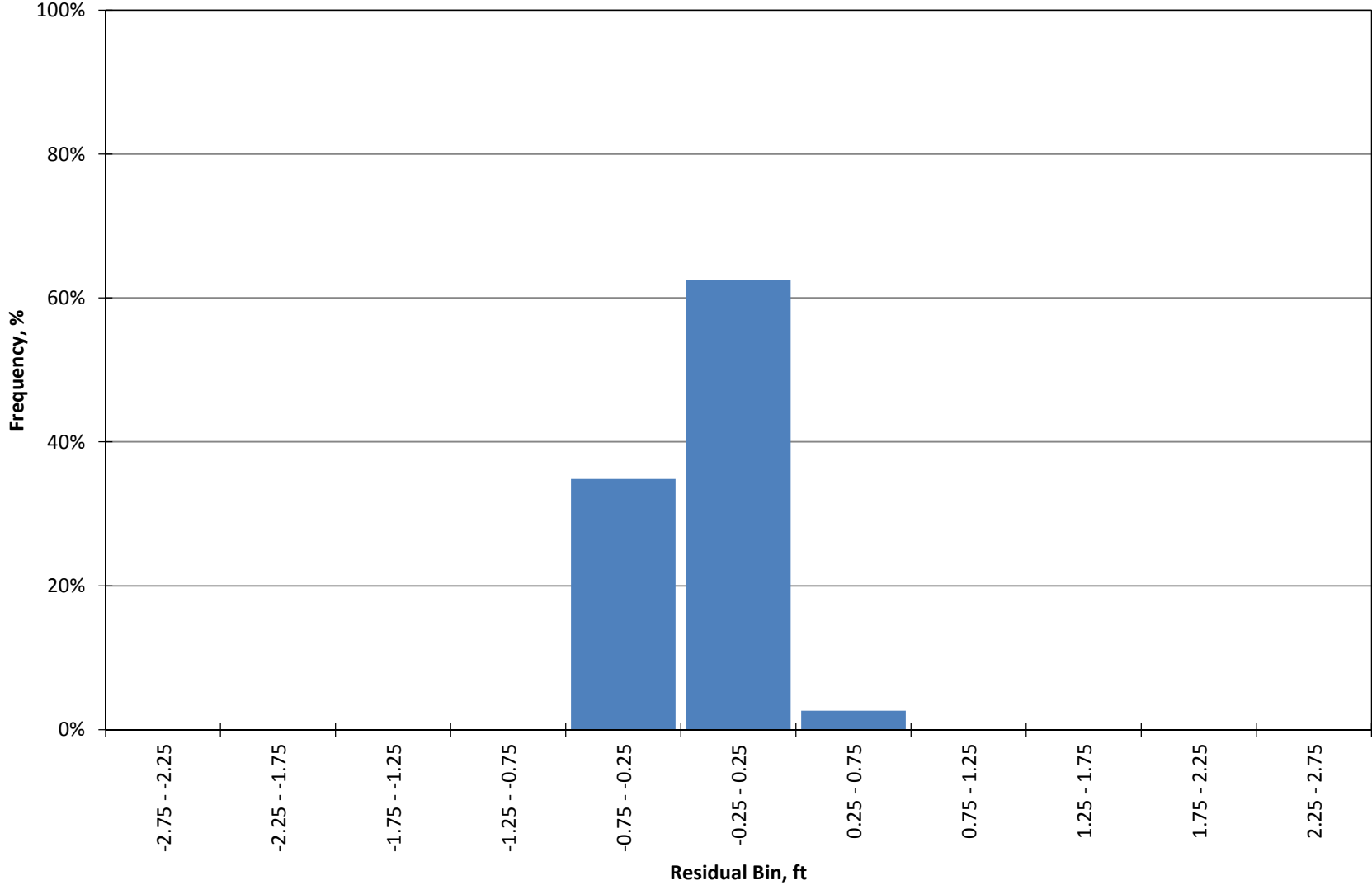


Figure 55

Histogram of Drawdown Residuals Transient Model Calibration (22-Apr-15 through 13-Jan-16) - MW-7S

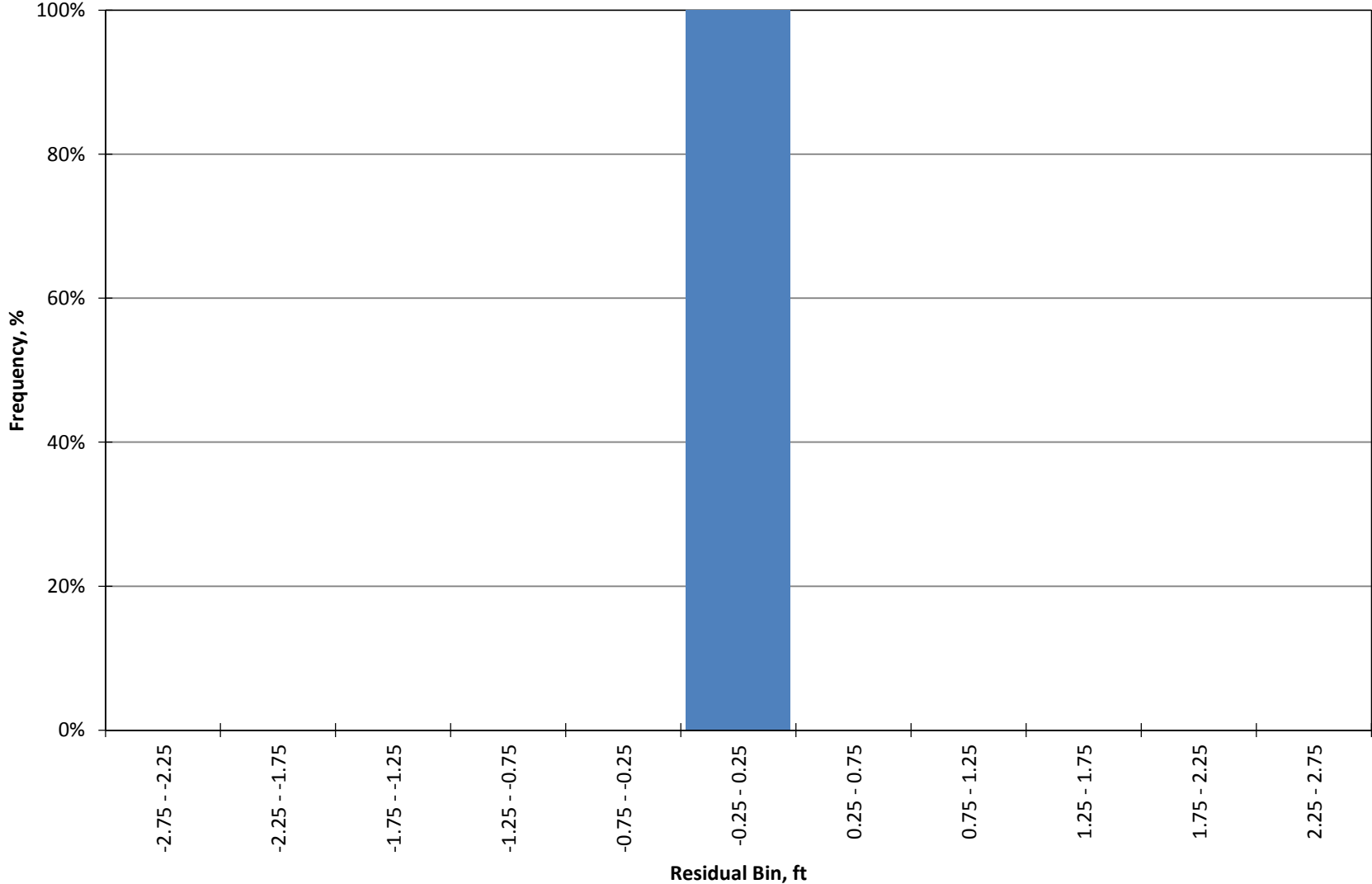


Figure 56

Histogram of Drawdown Residuals
Transient Model Calibration (22-Apr-15 through 13-Jan-16) - MW-7M

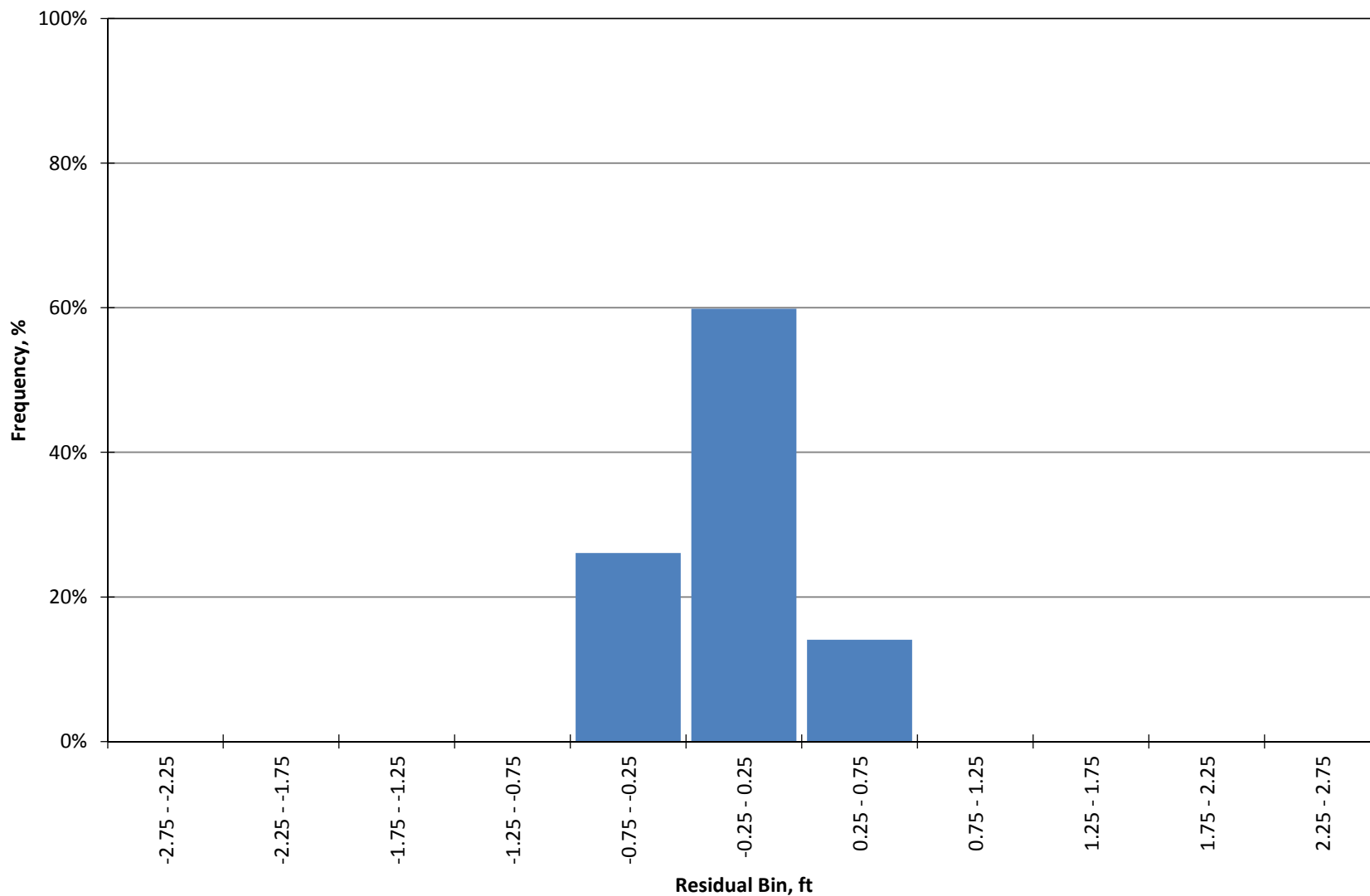


Figure 57

Drawdown Residuals through Time Transient Model Calibration (22-Apr-15 through 13-Jan-16) - MW-1S

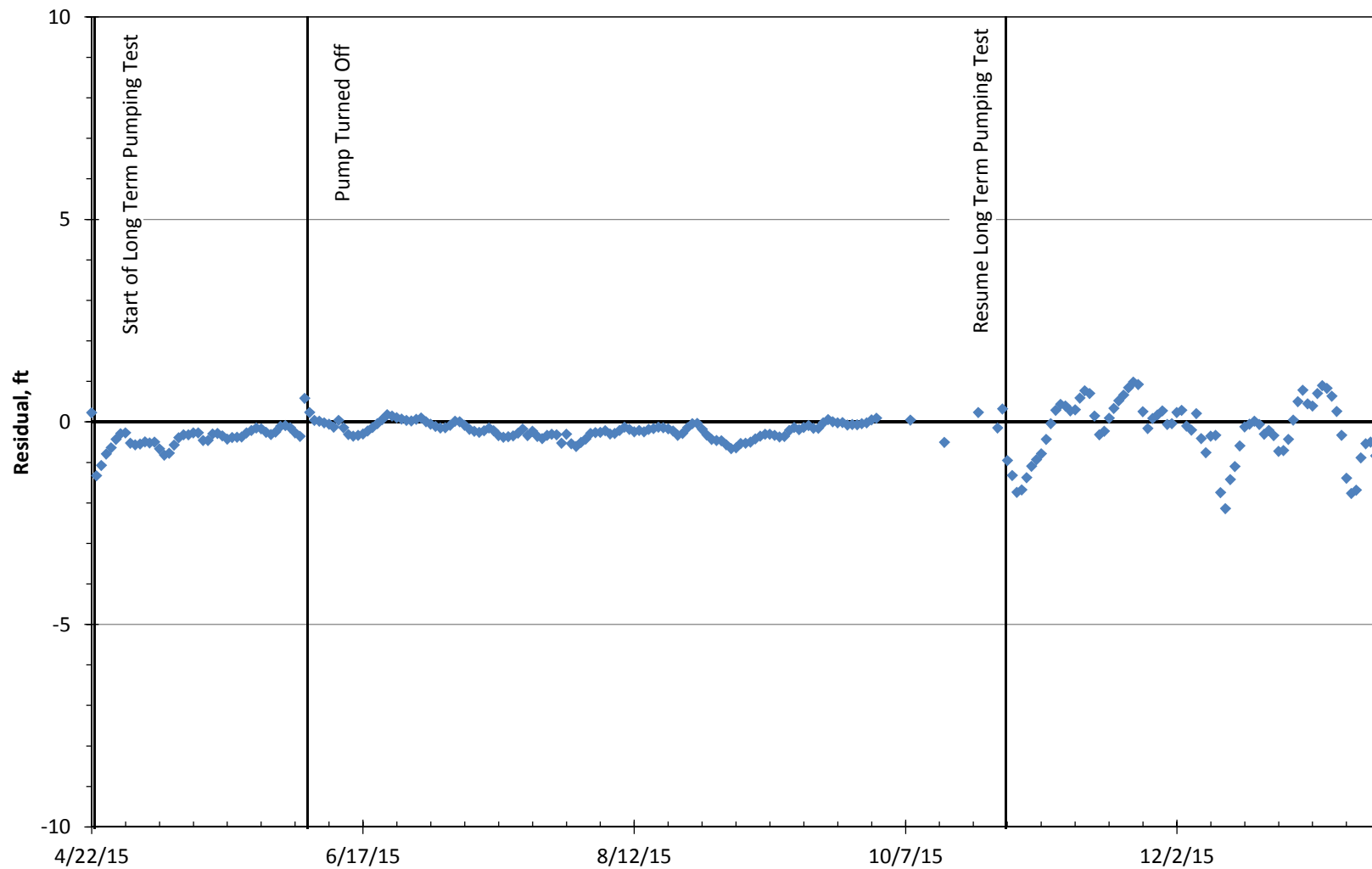


Figure 58

Drawdown Residuals through Time Transient Model Calibration (22-Apr-15 through 13-Jan-16) - MW-1M

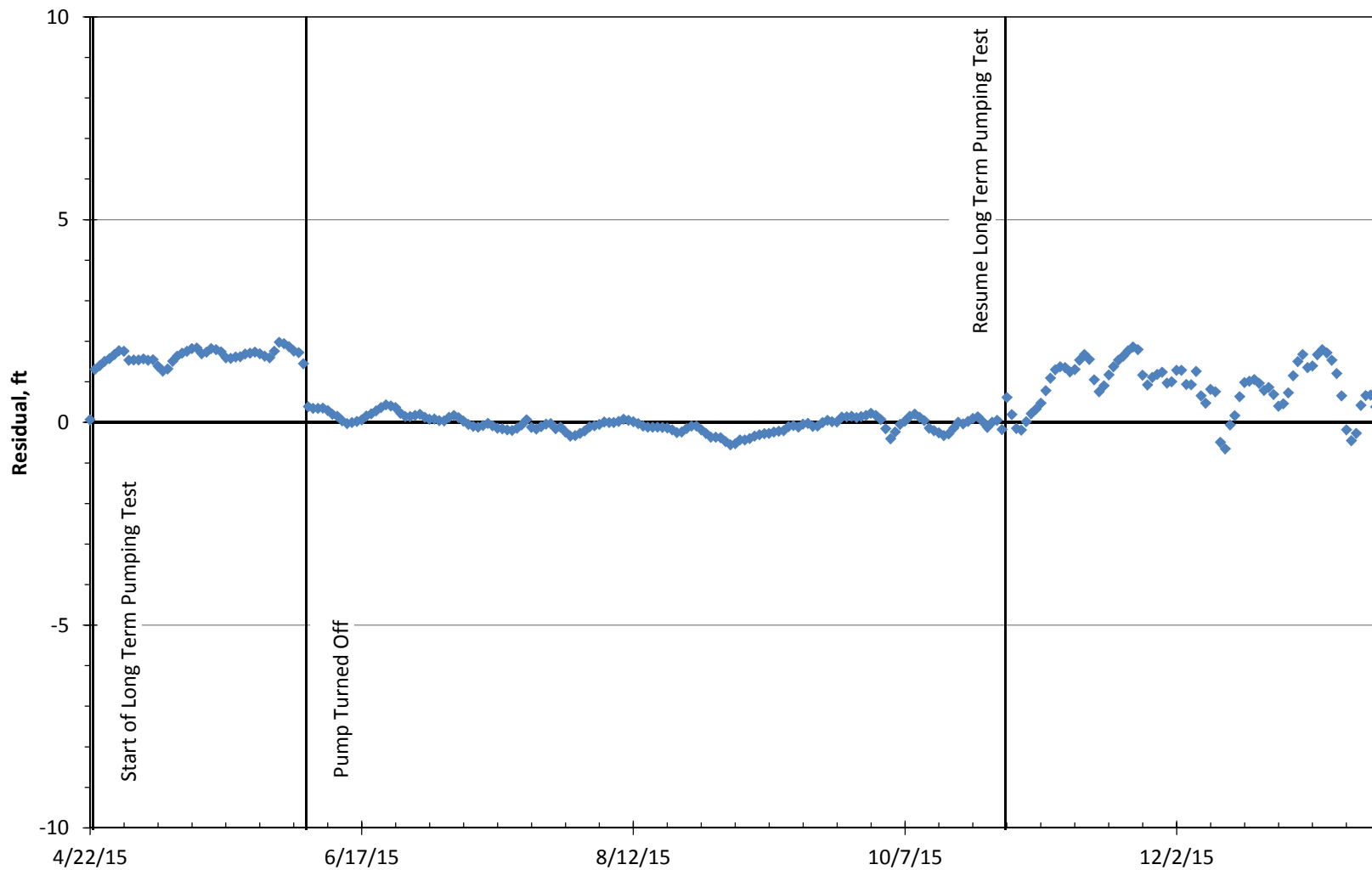


Figure 59

Drawdown Residuals through Time Transient Model Calibration (22-Apr-15 through 13-Jan-16) - MW-3S

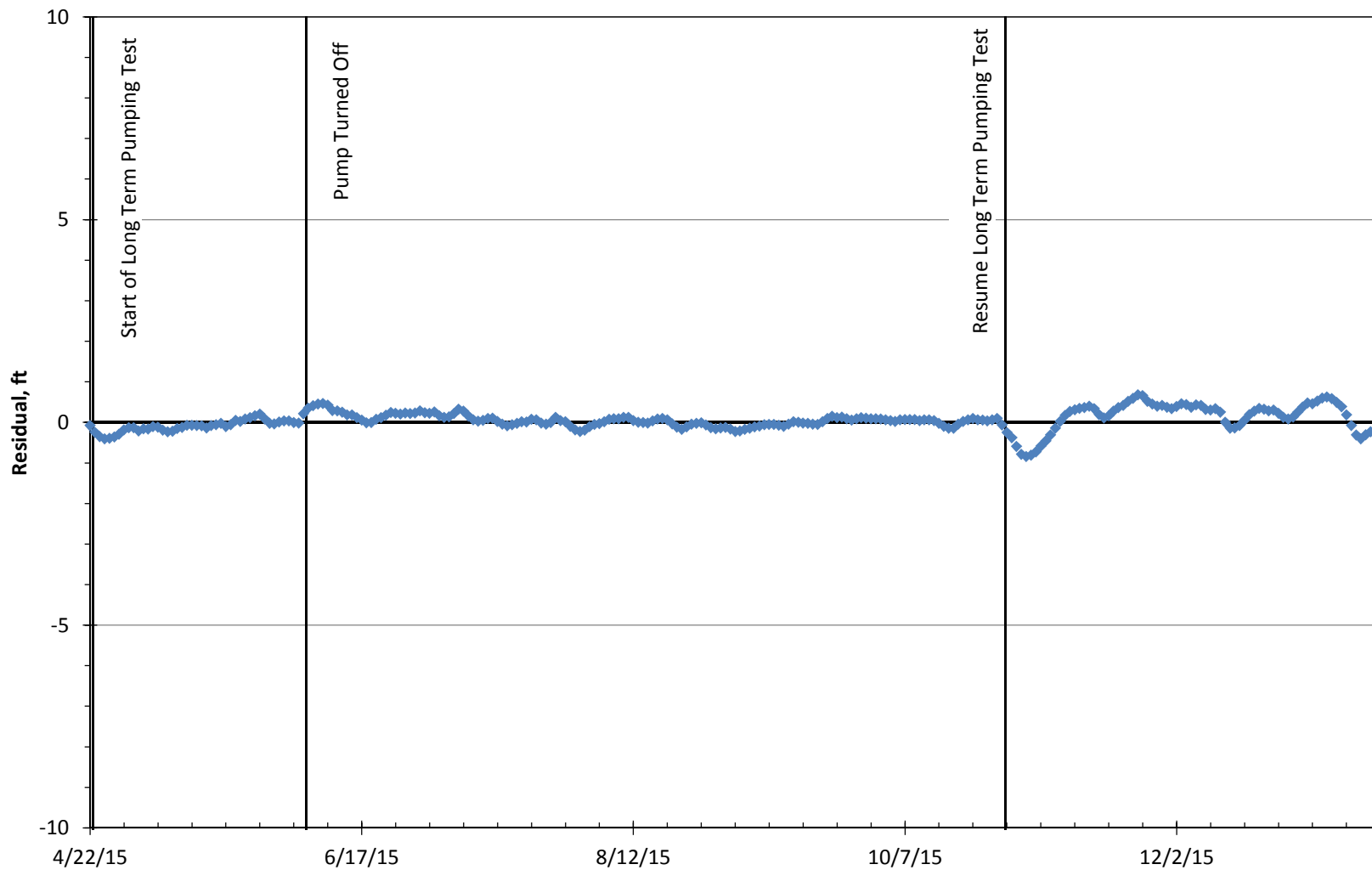


Figure 60

Drawdown Residuals through Time Transient Model Calibration (22-Apr-15 through 13-Jan-16) - MW-3M

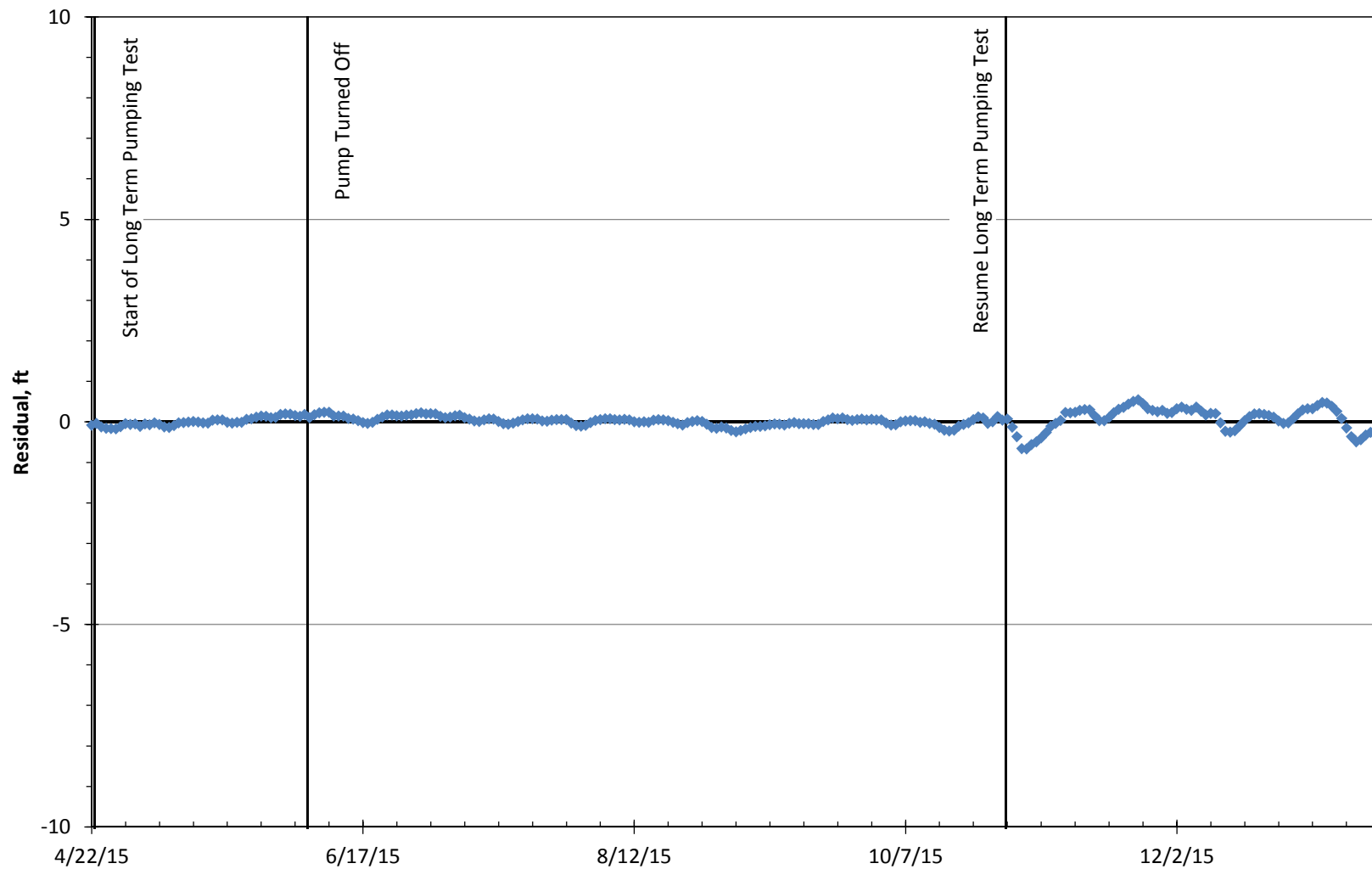


Figure 61

Drawdown Residuals through Time Transient Model Calibration (22-Apr-15 through 13-Jan-16) - MW-4S

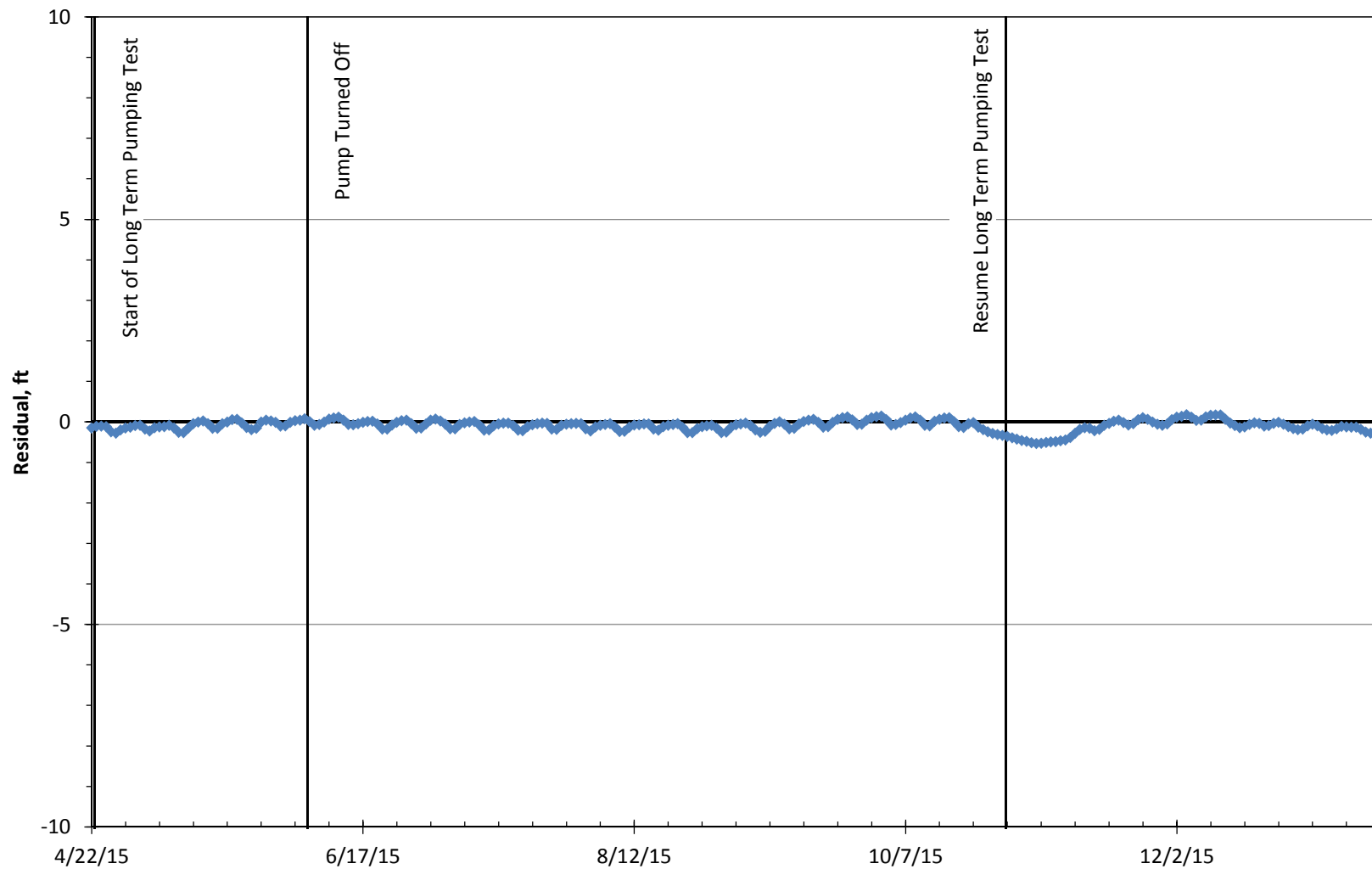


Figure 62

Drawdown Residuals through Time
Transient Model Calibration (22-Apr-15 through 13-Jan-16) - MW-4M

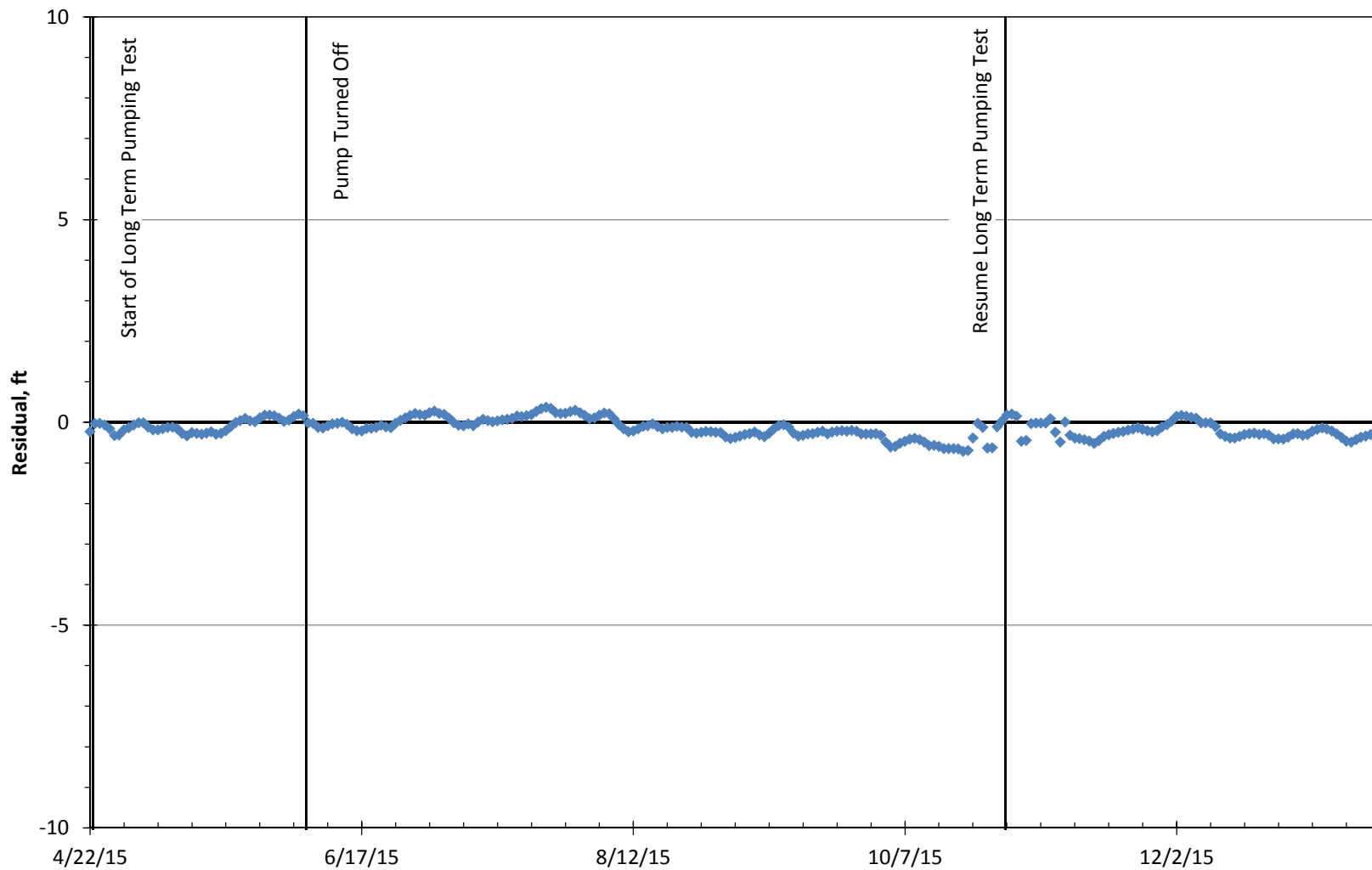


Figure 63

Drawdown Residuals through Time Transient Model Calibration (22-Apr-15 through 13-Jan-16) - MW-7S

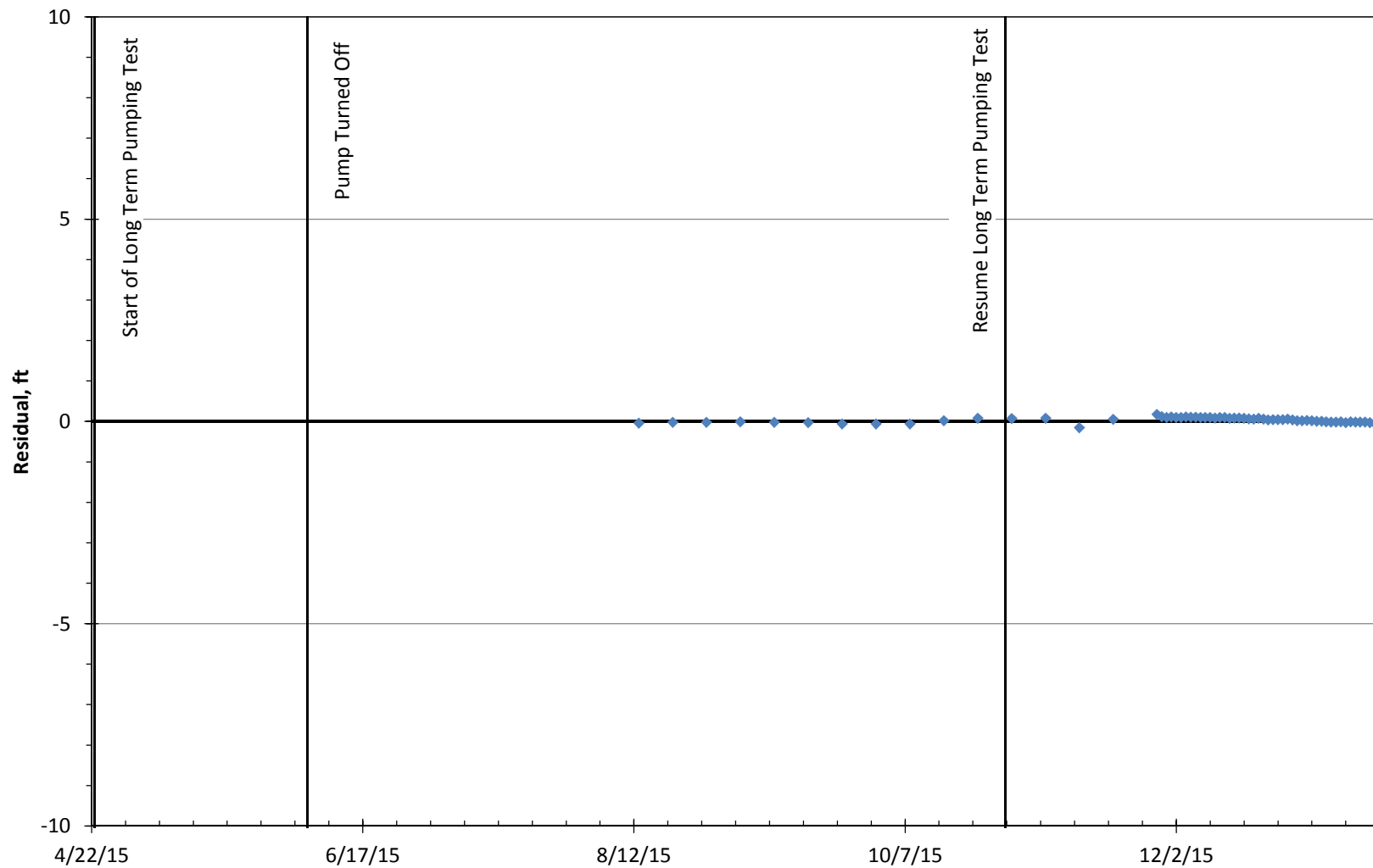


Figure 64

Drawdown Residuals through Time
Transient Model Calibration (22-Apr-15 through 13-Jan-16) - MW-7M

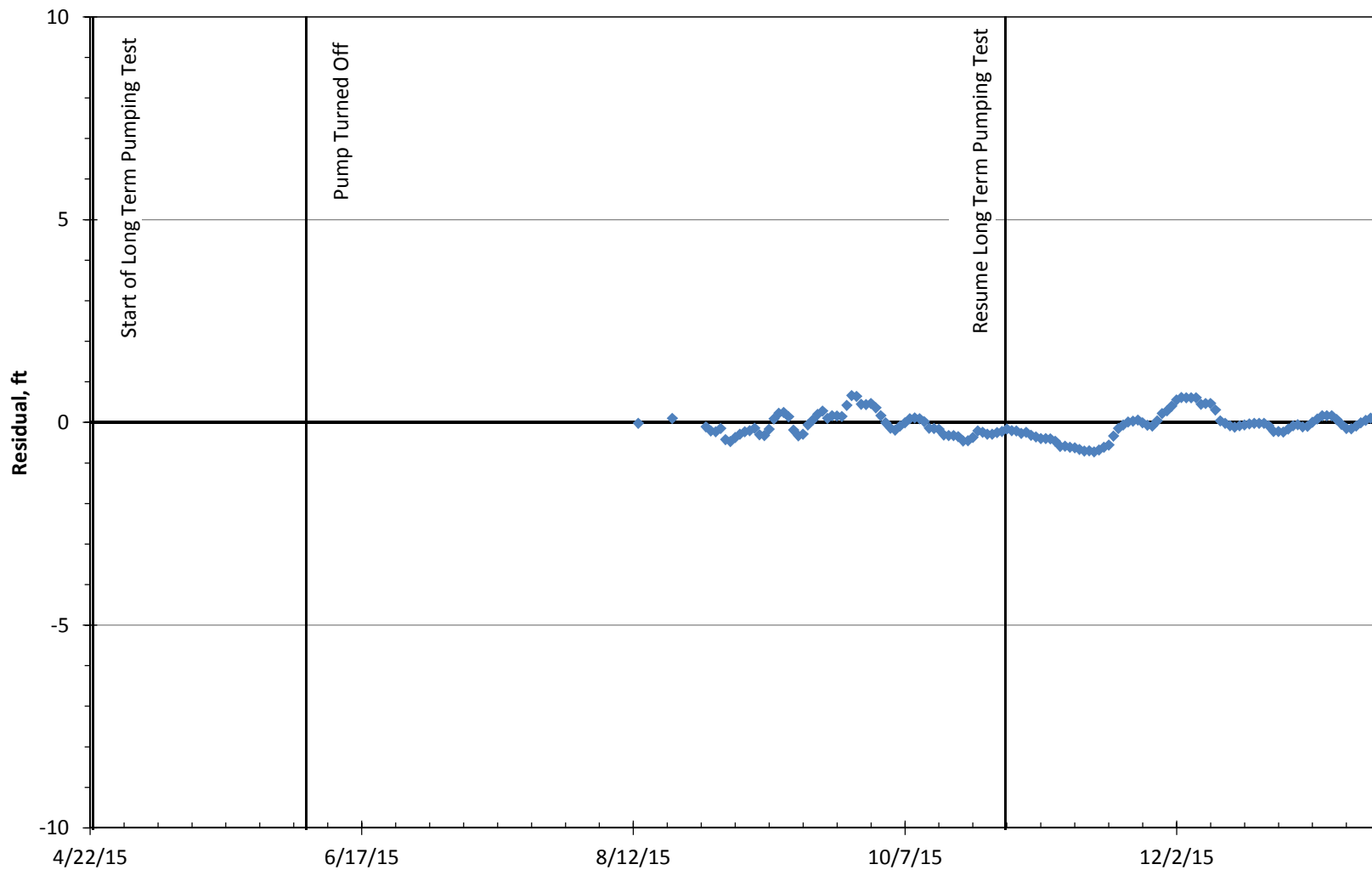
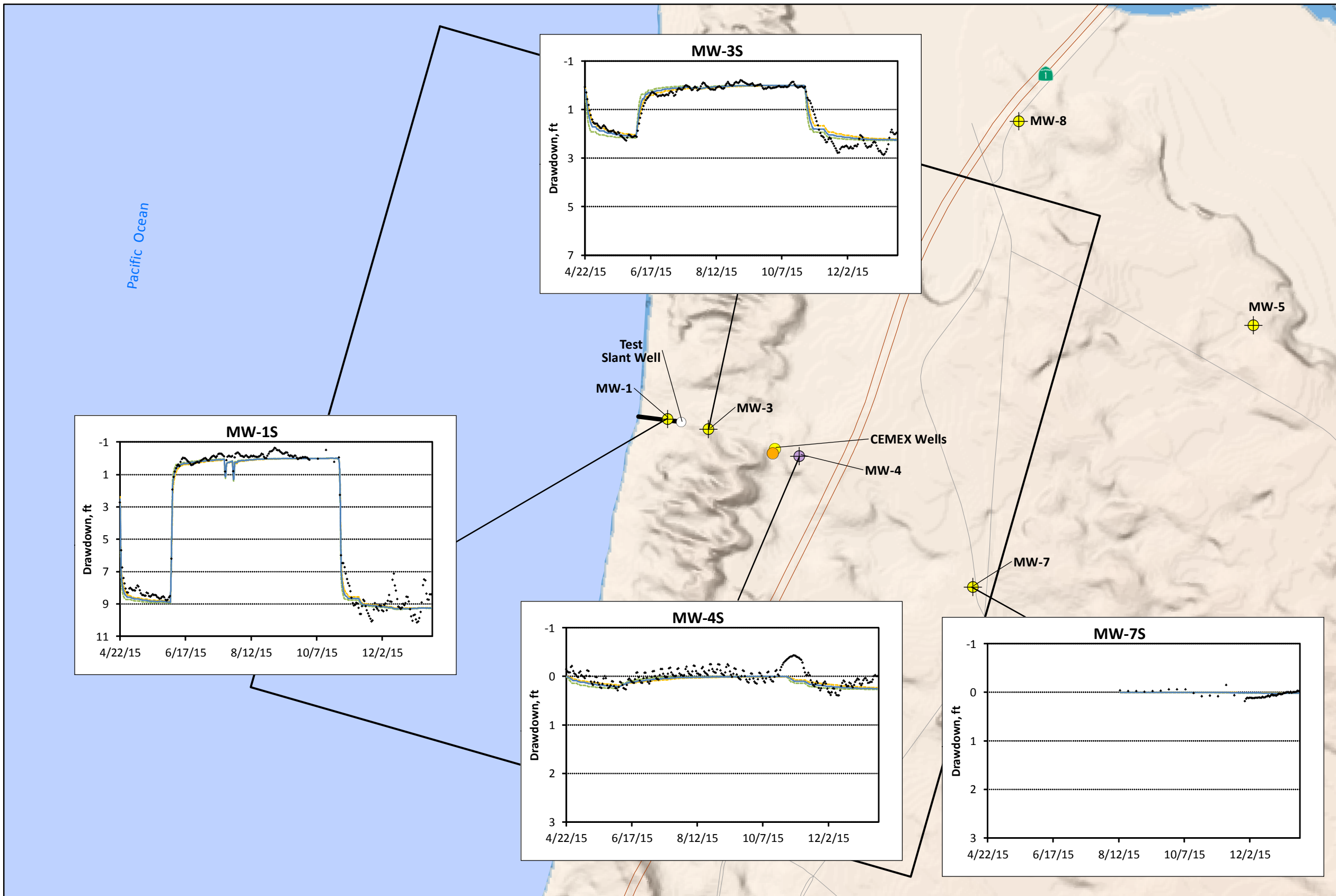


Figure 65

SELECTED HYDROGRAPHS
FOR DUNE SAND AQUIFER -
SENSITIVITY RUN
STORATIVITY OF
DUNE SAND AQUIFER



EXPLANATION

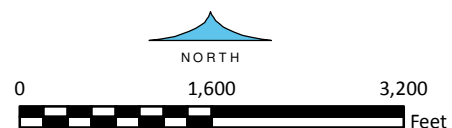
- CEMEX Model Boundary
- Monitoring Well Cluster
- Compliance Monitoring Well Cluster
- CEMEX Well - Inactive (Monitored)
- CEMEX Well - Active (Not Monitored)
- Test Slant Well

- 50% Storativity
- 150% Storativity
- Calibration
- Observed

8-Feb-17

Prepared by: DB. Map Projection: State Plane 1983, Zone IV.

© 2017, GEOSCIENCE Support Services, Inc. All rights reserved.

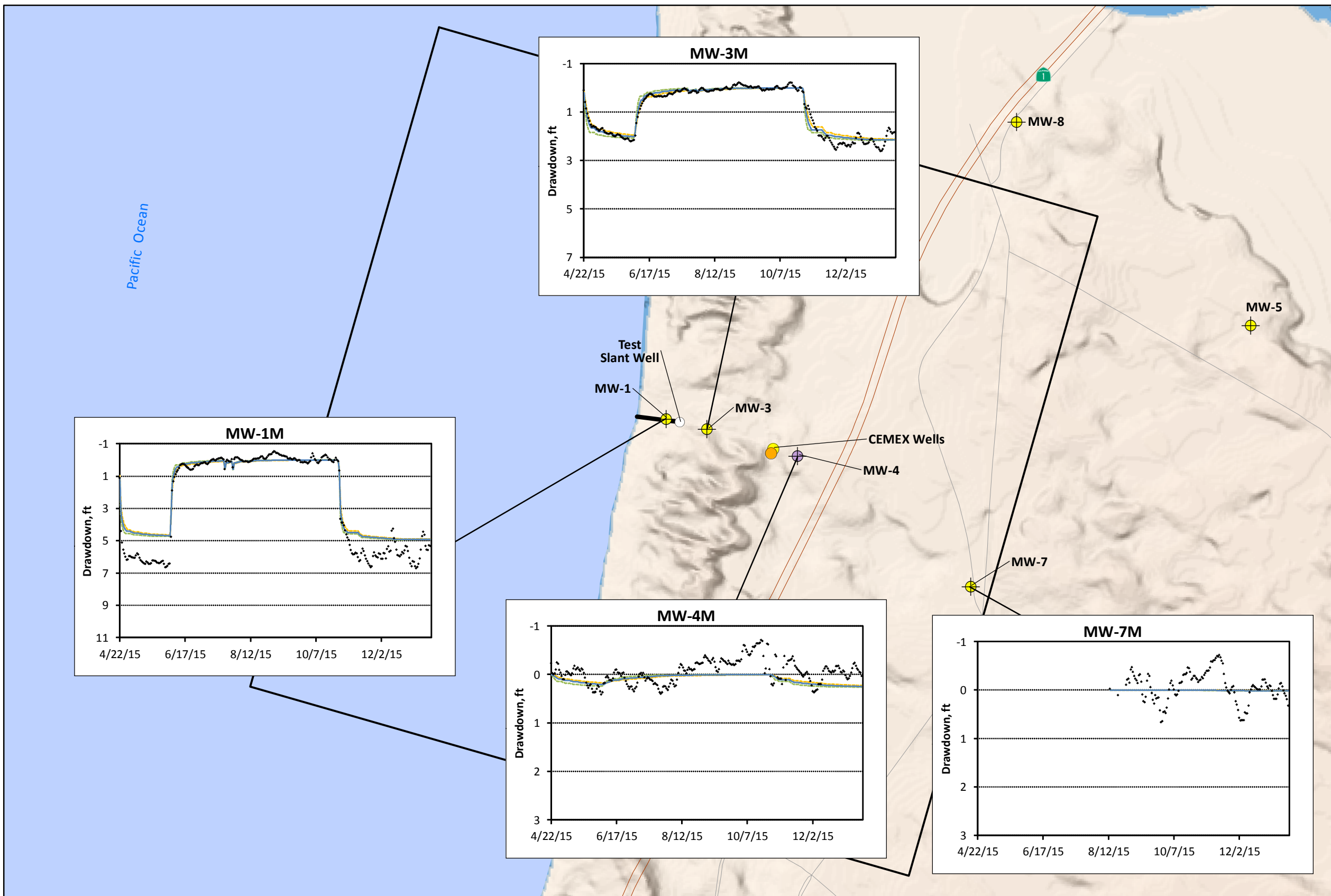


GEOSCIENCE

GEOSCIENCE Support Services, Inc.
P.O. Box 220, Claremont, CA 91711
Tel: (909) 451-6650 Fax: (909) 451-6638
www.gssiwater.com

Figure 66a

**SELECTED HYDROGRAPHS
FOR 180-FTE AQUIFER -
SENSITIVITY RUN
STORATIVITY OF
DUNE SAND AQUIFER**



EXPLANATION

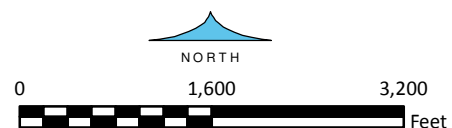
- CEMEX Model Boundary
- Monitoring Well Cluster
- Compliance Monitoring Well Cluster
- CEMEX Well - Inactive (Monitored)
- CEMEX Well - Active (Not Monitored)
- Test Slant Well

- 50% Storativity
- 150% Storativity
- Calibration
- Observed

8-Feb-17

Prepared by: DB. Map Projection: State Plane 1983, Zone IV.

© 2017, GEOSCIENCE Support Services, Inc. All rights reserved.

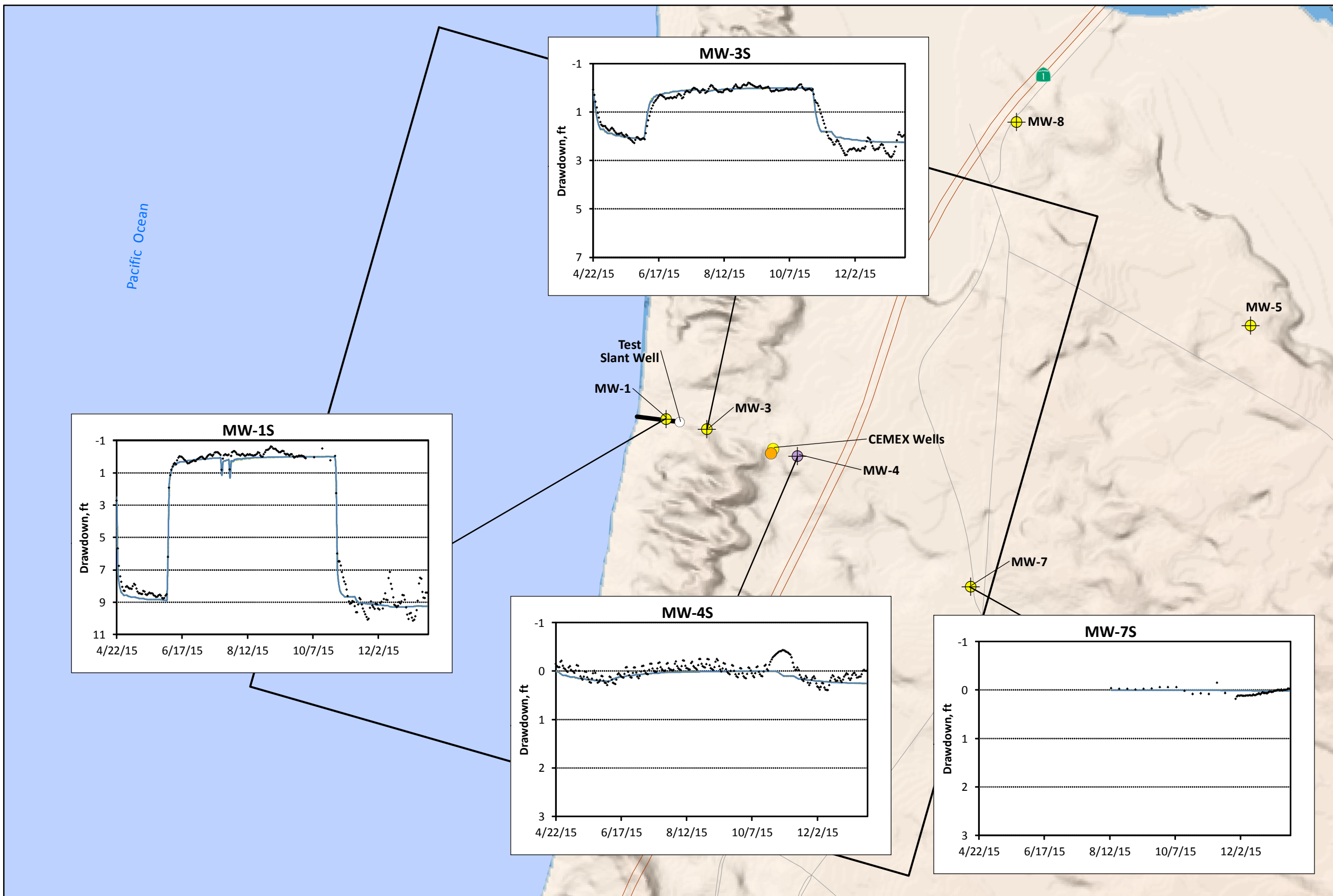


GEOSCIENCE

GEOSCIENCE Support Services, Inc.
P.O. Box 220, Claremont, CA 91711
Tel: (909) 451-6650 Fax: (909) 451-6638
www.gssiwater.com

Figure 66b

**SELECTED HYDROGRAPHS
FOR DUNE SAND AQUIFER -
SENSITIVITY RUN
STORATIVITY OF
180-FTE AQUIFER**



EXPLANATION

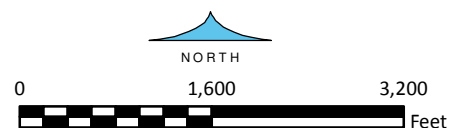
- CEMEX Model Boundary
- Monitoring Well Cluster
- Compliance Monitoring Well Cluster
- CEMEX Well - Inactive (Monitored)
- CEMEX Well - Active (Not Monitored)
- Test Slant Well

- 50% Storativity
- 150% Storativity
- Calibration
- Observed

8-Feb-17

Prepared by: DB. Map Projection: State Plane 1983, Zone IV.

© 2017, GEOSCIENCE Support Services, Inc. All rights reserved.

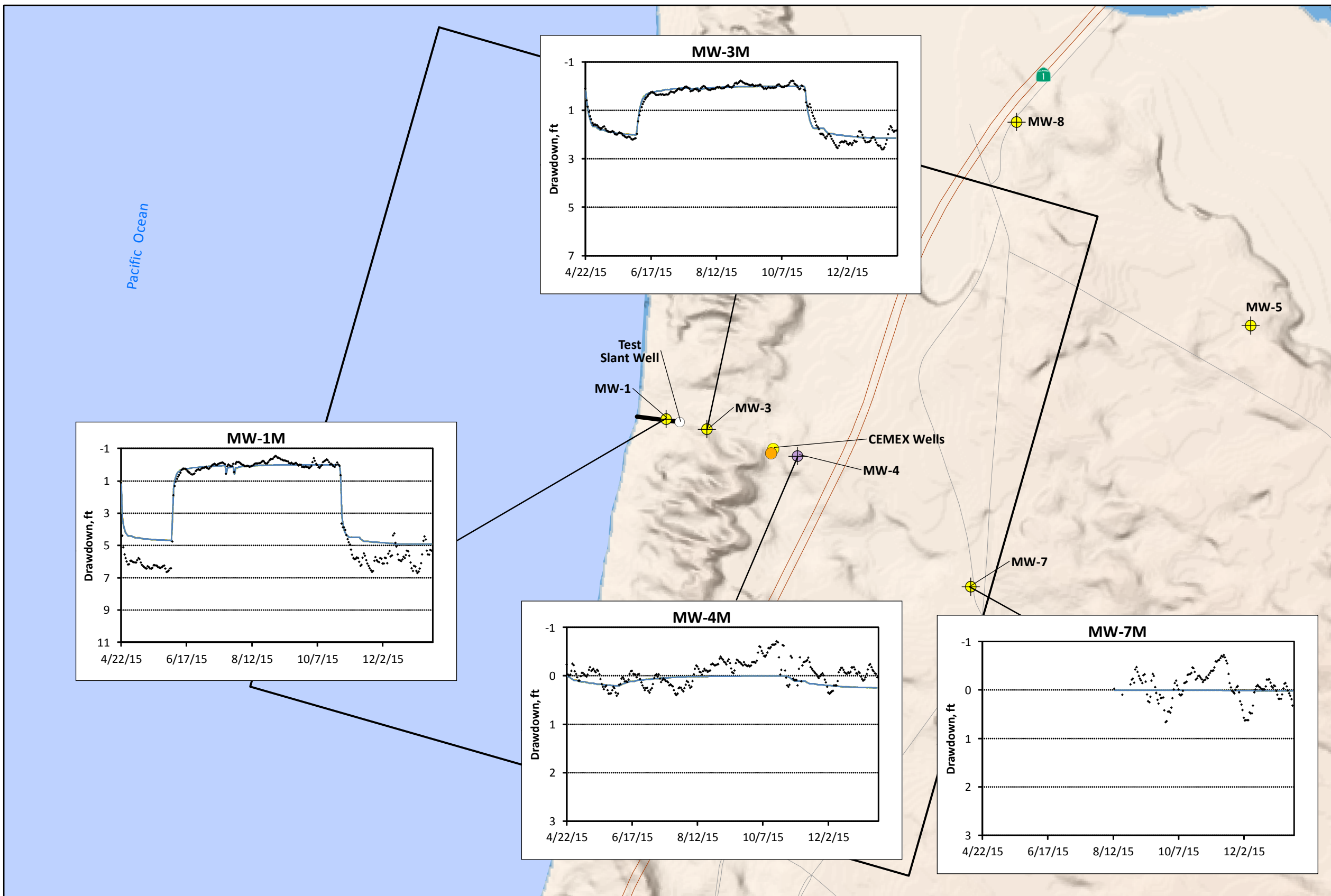


GEOSCIENCE

GEOSCIENCE Support Services, Inc.
P.O. Box 220, Claremont, CA 91711
Tel: (909) 451-6650 Fax: (909) 451-6638
www.gssiwater.com

Figure 67a

**SELECTED HYDROGRAPHS
FOR 180-FTE AQUIFER -
SENSITIVITY RUN
STORATIVITY OF
180-FTE AQUIFER**



EXPLANATION

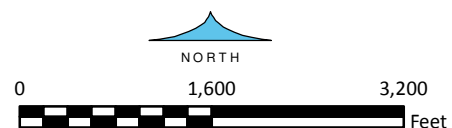
- CEMEX Model Boundary
- Monitoring Well Cluster
- Compliance Monitoring Well Cluster
- CEMEX Well - Inactive (Monitored)
- CEMEX Well - Active (Not Monitored)
- Test Slant Well

- 50% Storativity
- 150% Storativity
- Calibration
- Observed

8-Feb-17

Prepared by: DB. Map Projection: State Plane 1983, Zone IV.

© 2017, GEOSCIENCE Support Services, Inc. All rights reserved.

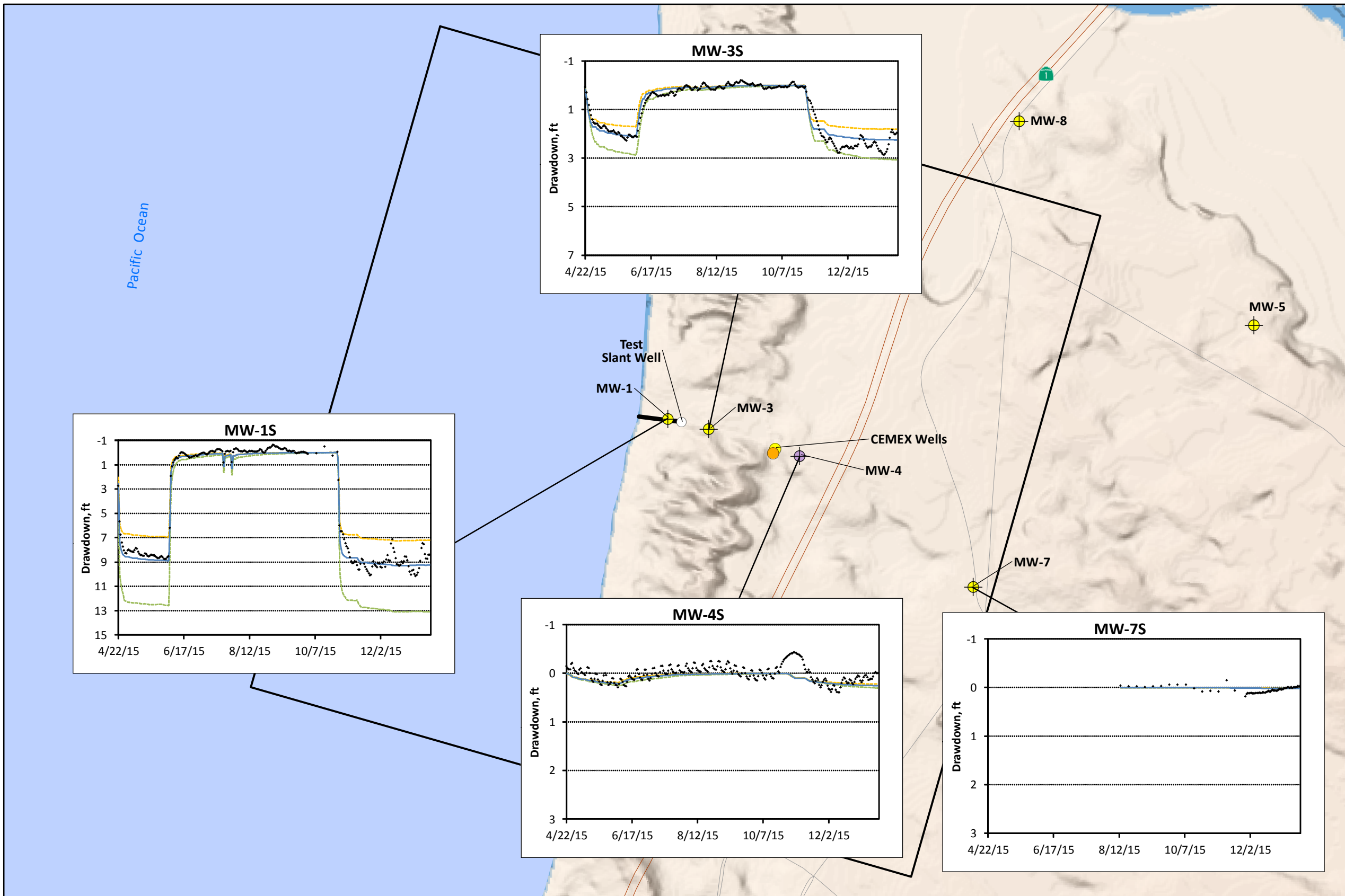


GEOSCIENCE

GEOSCIENCE Support Services, Inc.
P.O. Box 220, Claremont, CA 91711
Tel: (909) 451-6650 Fax: (909) 451-6638
www.gssiwater.com

Figure 67b

**SELECTED HYDROGRAPHS
FOR DUNE SAND AQUIFER -
SENSITIVITY RUN
HORIZONTAL HYDRAULIC
CONDUCTIVITY OF
DUNE SAND AQUIFER**



EXPLANATION

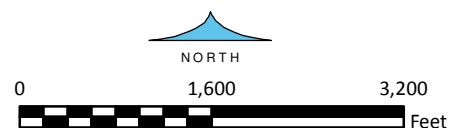
- CEMEX Model Boundary
- Monitoring Well Cluster
- Compliance Monitoring Well Cluster
- CEMEX Well - Inactive (Monitored)
- CEMEX Well - Active (Not Monitored)
- Test Slant Well

- 50% Horiz. Hydraulic Conductivity
- 150% Horiz. Hydraulic Conductivity
- Calibration
- Observed

8-Feb-17

Prepared by: DB. Map Projection: State Plane 1983, Zone IV.

© 2017, GEOSCIENCE Support Services, Inc. All rights reserved.

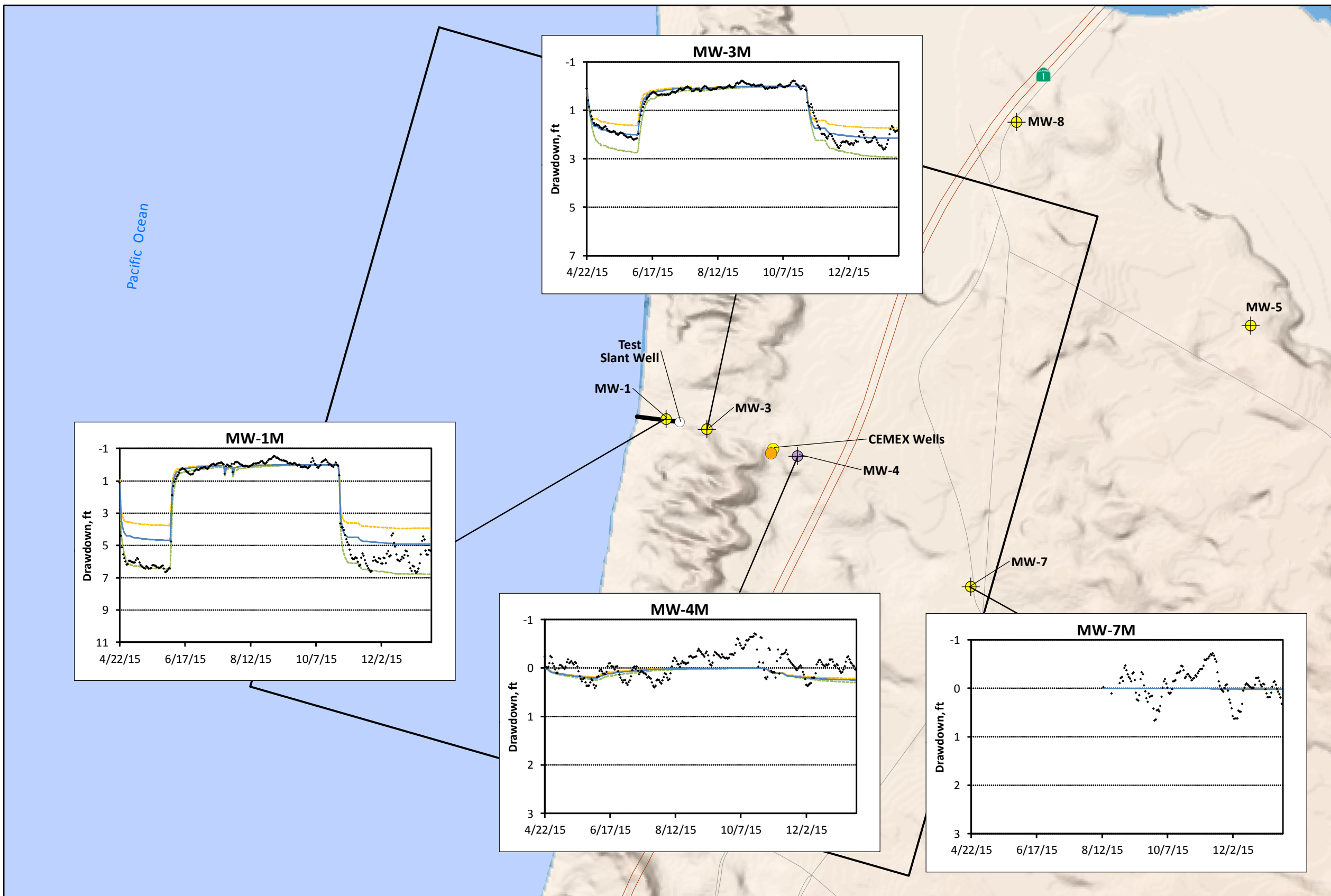


GEOSCIENCE

GEOSCIENCE Support Services, Inc.
P.O. Box 220, Claremont, CA 91711
Tel: (909) 451-6650 Fax: (909) 451-6638
www.gssiwater.com

Figure 68a

**SELECTED HYDROGRAPHS
FOR 180-FTE AQUIFER -
SENSITIVITY RUN
HORIZONTAL HYDRAULIC
CONDUCTIVITY OF
DUNE SAND AQUIFER**



EXPLANATION

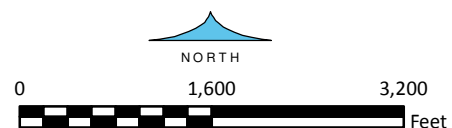
- CEMEX Model Boundary
- Monitoring Well Cluster
- Compliance Monitoring Well Cluster
- CEMEX Well - Inactive (Monitored)
- CEMEX Well - Active (Not Monitored)
- Test Slant Well

- 50% Horiz. Hydraulic Conductivity
- 150% Horiz. Hydraulic Conductivity
- Calibration
- Observed

8-Feb-17

Prepared by: DB. Map Projection: State Plane 1983, Zone IV.

© 2017, GEOSCIENCE Support Services, Inc. All rights reserved.

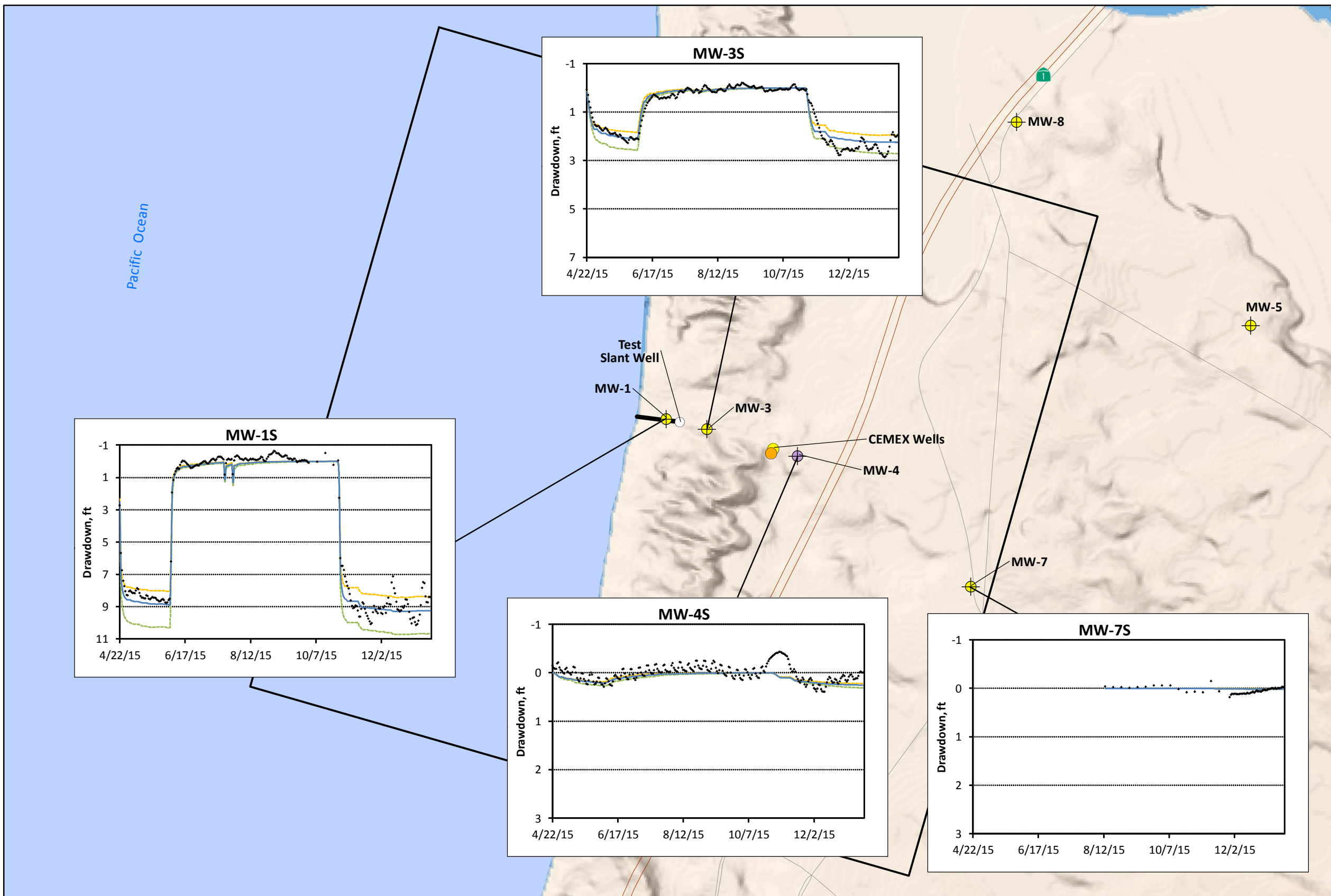


GEOSCIENCE

GEOSCIENCE Support Services, Inc.
P.O. Box 220, Claremont, CA 91711
Tel: (909) 451-6650 Fax: (909) 451-6638
www.gssiwater.com

Figure 68b

**SELECTED HYDROGRAPHS
DUNE SAND AQUIFER -
SENSITIVITY RUN
HORIZONTAL HYDRAULIC
CONDUCTIVITY OF
180-FTE AQUIFER**



EXPLANATION

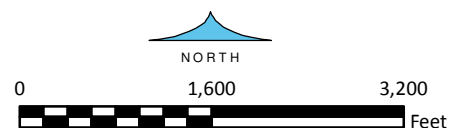
- CEMEX Model Boundary
- Monitoring Well Cluster
- Compliance Monitoring Well Cluster
- CEMEX Well - Inactive (Monitored)
- CEMEX Well - Active (Not Monitored)
- Test Slant Well

- 50% Horiz. Hydraulic Conductivity
- 150% Horiz. Hydraulic Conductivity
- Calibration
- Observed

8-Feb-17

Prepared by: DB. Map Projection: State Plane 1983, Zone IV.

© 2017, GEOSCIENCE Support Services, Inc. All rights reserved.

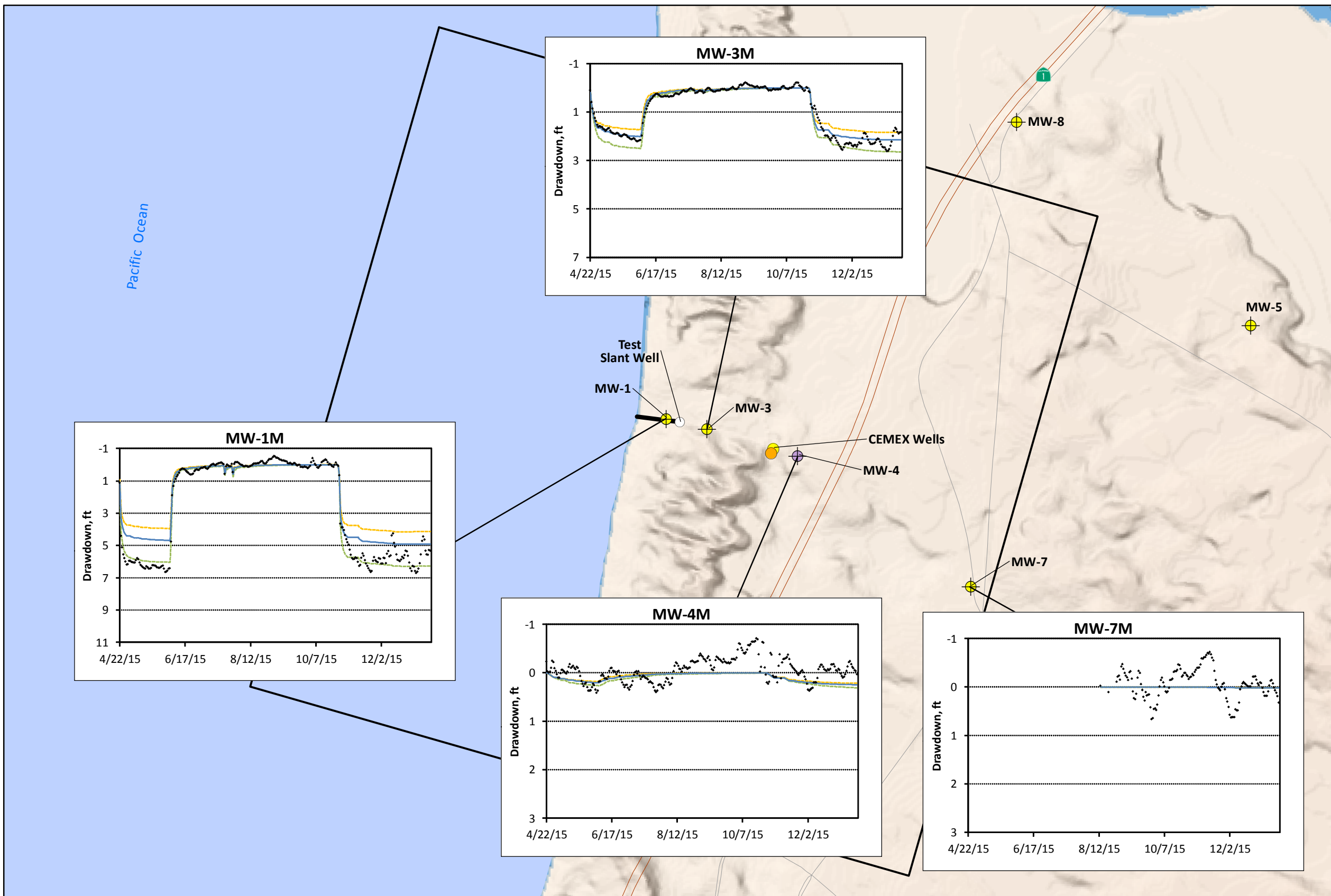


GEOSCIENCE

GEOSCIENCE Support Services, Inc.
P.O. Box 220, Claremont, CA 91711
Tel: (909) 451-6650 Fax: (909) 451-6638
www.gssiwater.com

Figure 69a

**SELECTED HYDROGRAPHS
180-FTE AQUIFER -
SENSITIVITY RUN
HORIZONTAL HYDRAULIC
CONDUCTIVITY OF
180-FTE AQUIFER**

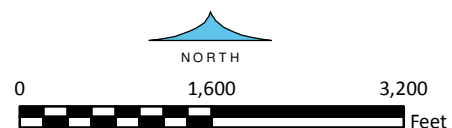


- EXPLANATION**
- CEMEX Model Boundary
 - Monitoring Well Cluster
 - Compliance Monitoring Well Cluster
 - CEMEX Well - Inactive (Monitored)
 - CEMEX Well - Active (Not Monitored)
 - Test Slant Well
-
- 50% Horiz. Hydraulic Conductivity
 - 150% Horiz. Hydraulic Conductivity
 - Calibration
 - Observed

8-Feb-17

Prepared by: DB. Map Projection: State Plane 1983, Zone IV.

© 2017, GEOSCIENCE Support Services, Inc. All rights reserved.

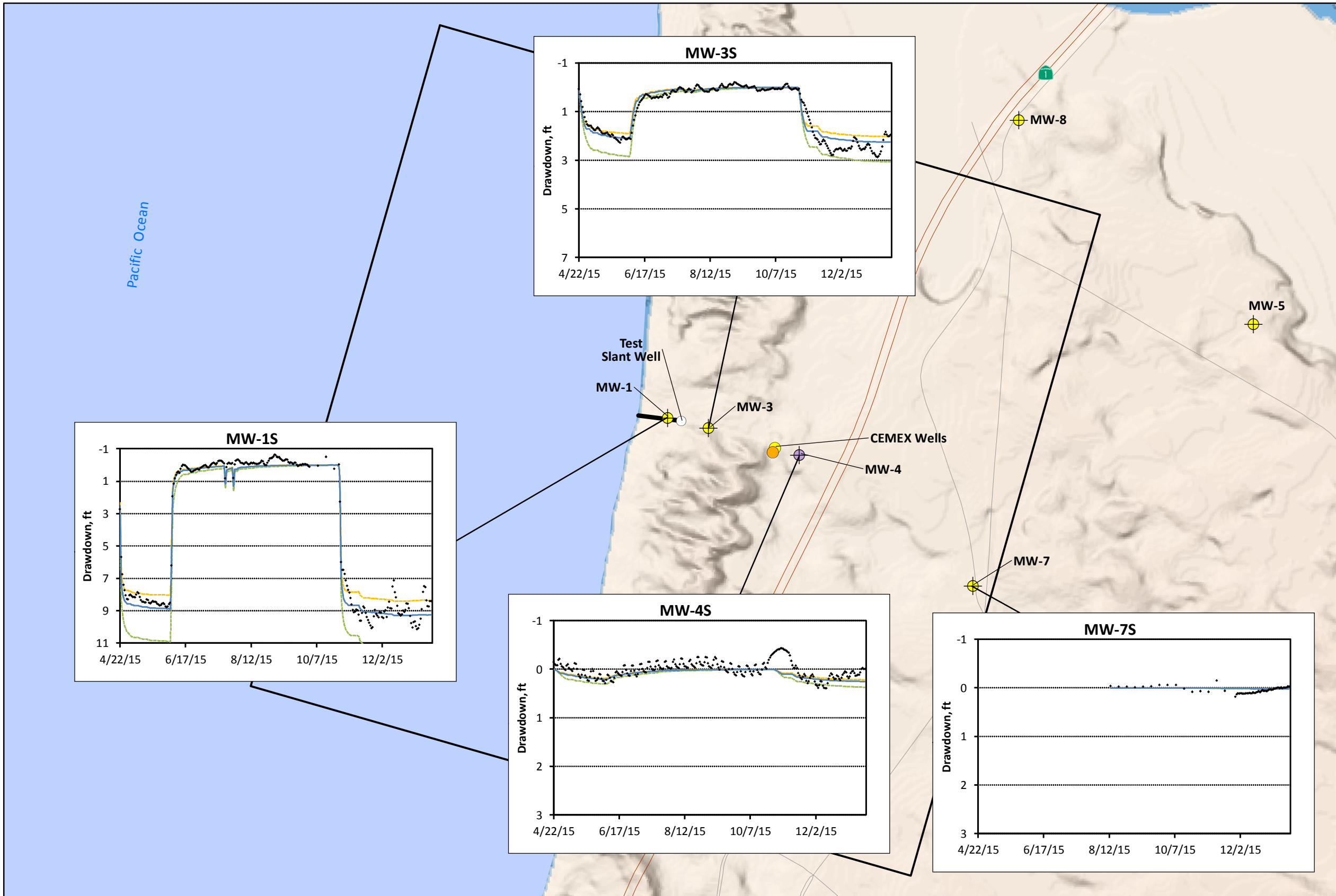


GEOSCIENCE

GEOSCIENCE Support Services, Inc.
P.O. Box 220, Claremont, CA 91711
Tel: (909) 451-6650 Fax: (909) 451-6638
www.gssiwater.com

Figure 69b

**SELECTED HYDROGRAPHS
DUNE SAND AQUIFER -
SENSITIVITY RUN
VERTICAL HYDRAULIC
CONDUCTIVITY OF
DUNE SAND AQUIFER**



EXPLANATION

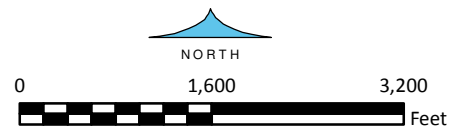
- CEMEX Model Boundary
- Monitoring Well Cluster
- Compliance Monitoring Well Cluster
- CEMEX Well - Inactive (Monitored)
- CEMEX Well - Active (Not Monitored)
- Test Slant Well

- 50% Vert. Hydraulic Conductivity
- 150% Vert. Hydraulic Conductivity
- Calibration
- Observed

8-Feb-17

Prepared by: DB. Map Projection: State Plane 1983, Zone IV.

© 2017, GEOSCIENCE Support Services, Inc. All rights reserved.

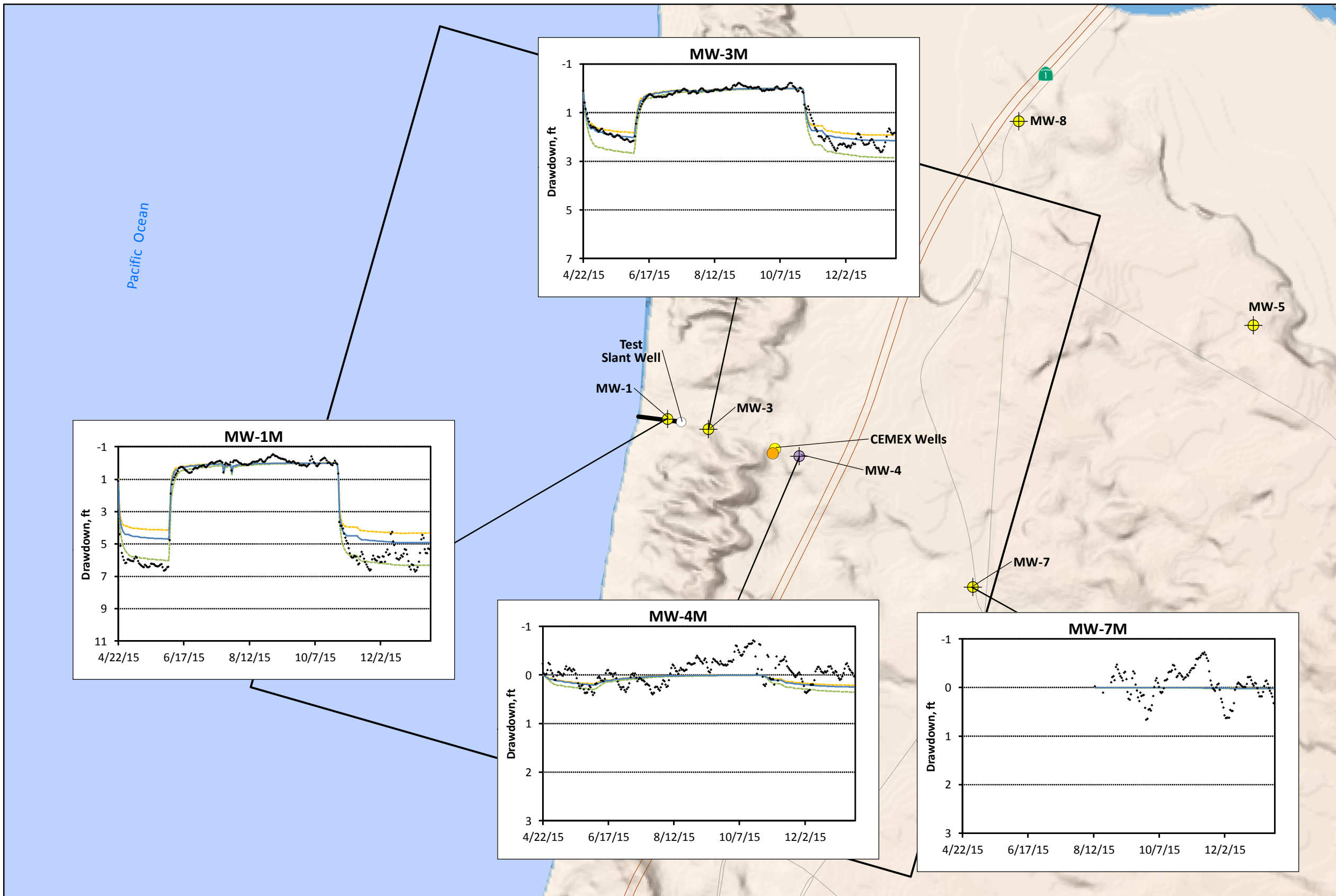


GEOSCIENCE

GEOSCIENCE Support Services, Inc.
P.O. Box 220, Claremont, CA 91711
Tel: (909) 451-6650 Fax: (909) 451-6638
www.gssiwater.com

Figure 70a

**SELECTED HYDROGRAPHS
180-FTE AQUIFER -
SENSITIVITY RUN
VERTICAL HYDRAULIC
CONDUCTIVITY OF
DUNE SAND AQUIFER**



EXPLANATION

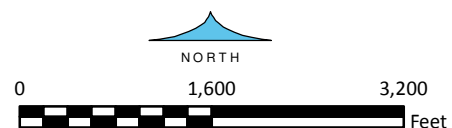
- CEMEX Model Boundary
- Monitoring Well Cluster
- Compliance Monitoring Well Cluster
- CEMEX Well - Inactive (Monitored)
- CEMEX Well - Active (Not Monitored)
- Test Slant Well

- 50% Vert. Hydraulic Conductivity
- 150% Vert. Hydraulic Conductivity
- Calibration
- Observed

8-Feb-17

Prepared by: DB. Map Projection: State Plane 1983, Zone IV.

© 2017, GEOSCIENCE Support Services, Inc. All rights reserved.

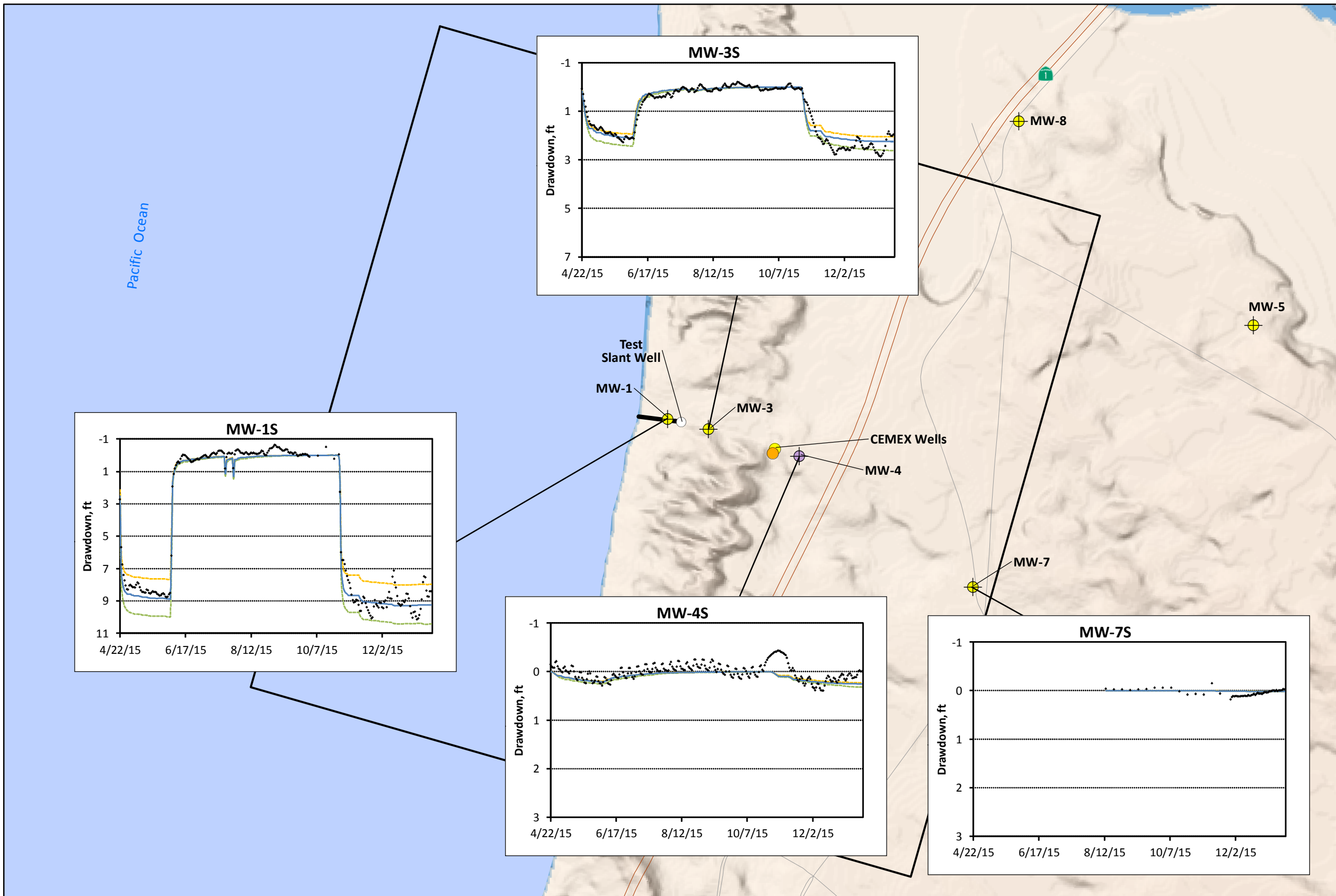


GEOSCIENCE

GEOSCIENCE Support Services, Inc.
P.O. Box 220, Claremont, CA 91711
Tel: (909) 451-6650 Fax: (909) 451-6638
www.gssiwater.com

Figure 70b

**SELECTED HYDROGRAPHS
DUNE SAND AQUIFER -
SENSITIVITY RUN
VERTICAL HYDRAULIC
CONDUCTIVITY OF
180-FTE AQUIFER**



EXPLANATION

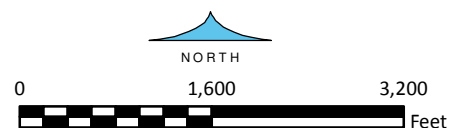
- CEMEX Model Boundary
- Monitoring Well Cluster
- Compliance Monitoring Well Cluster
- CEMEX Well - Inactive (Monitored)
- CEMEX Well - Active (Not Monitored)
- Test Slant Well

- 50% Vert. Hydraulic Conductivity
- 150% Vert. Hydraulic Conductivity
- Calibration
- Observed

8-Feb-17

Prepared by: DB. Map Projection: State Plane 1983, Zone IV.

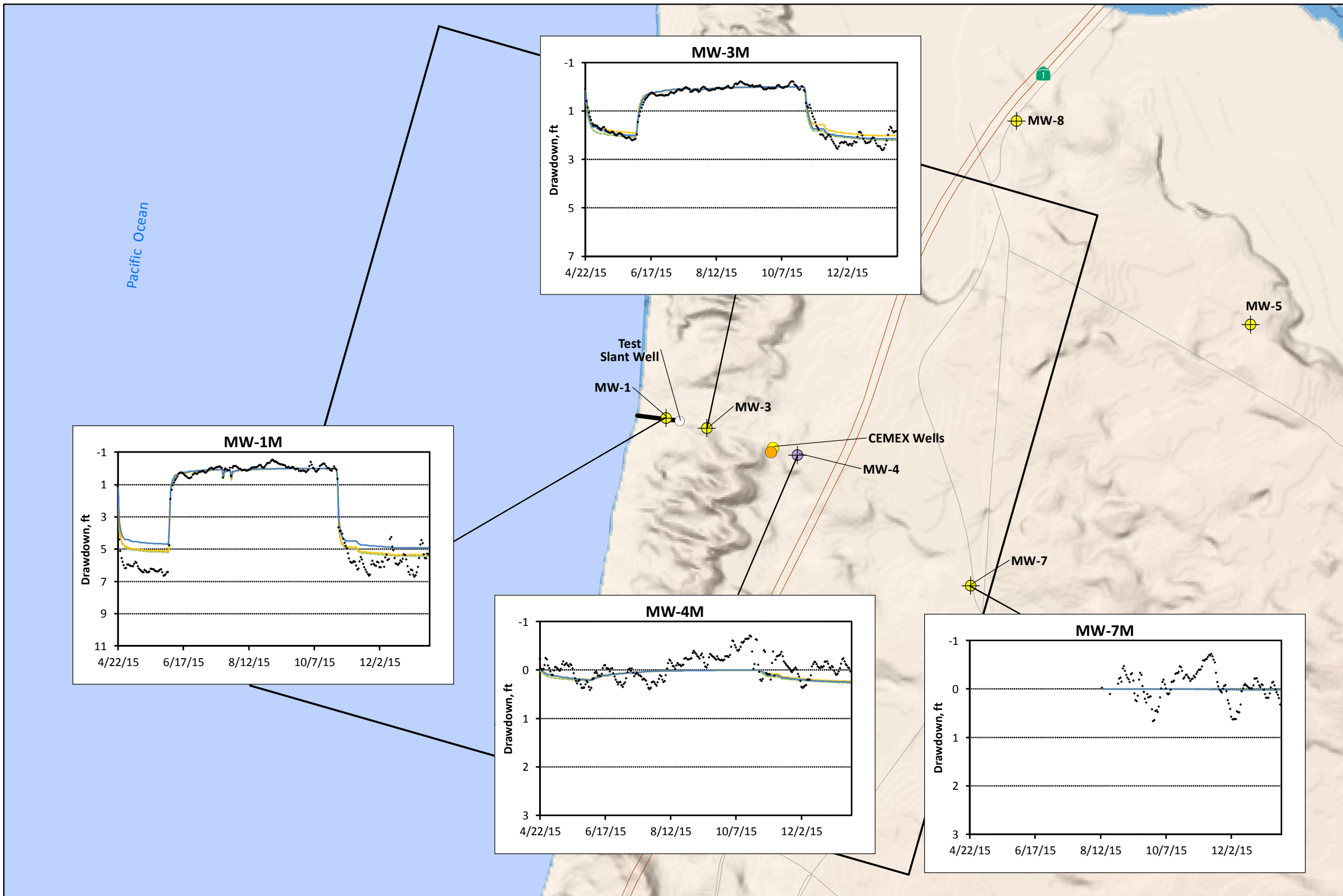
© 2017, GEOSCIENCE Support Services, Inc. All rights reserved.



GEOSCIENCE Support Services, Inc.
P.O. Box 220, Claremont, CA 91711
Tel: (909) 451-6650 Fax: (909) 451-6638
www.gssiwater.com

Figure 71a

**SELECTED HYDROGRAPHS
FOR 180-FTE AQUIFER -
SENSITIVITY RUN
VERTICAL HYDRAULIC
CONDUCTIVITY OF
180-FTE AQUIFER**



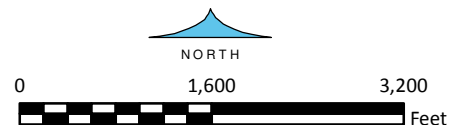
EXPLANATION

- CEMEX Model Boundary
- Monitoring Well Cluster
- Compliance Monitoring Well Cluster
- CEMEX Well - Inactive (Monitored)
- CEMEX Well - Active (Not Monitored)
- Test Slant Well
- 50% Vert. Hydraulic Conductivity
- 150% Vert. Hydraulic Conductivity
- Calibration
- Observed

8-Feb-17

Prepared by: DB. Map Projection: State Plane 1983, Zone IV.

© 2017, GEOSCIENCE Support Services, Inc. All rights reserved.

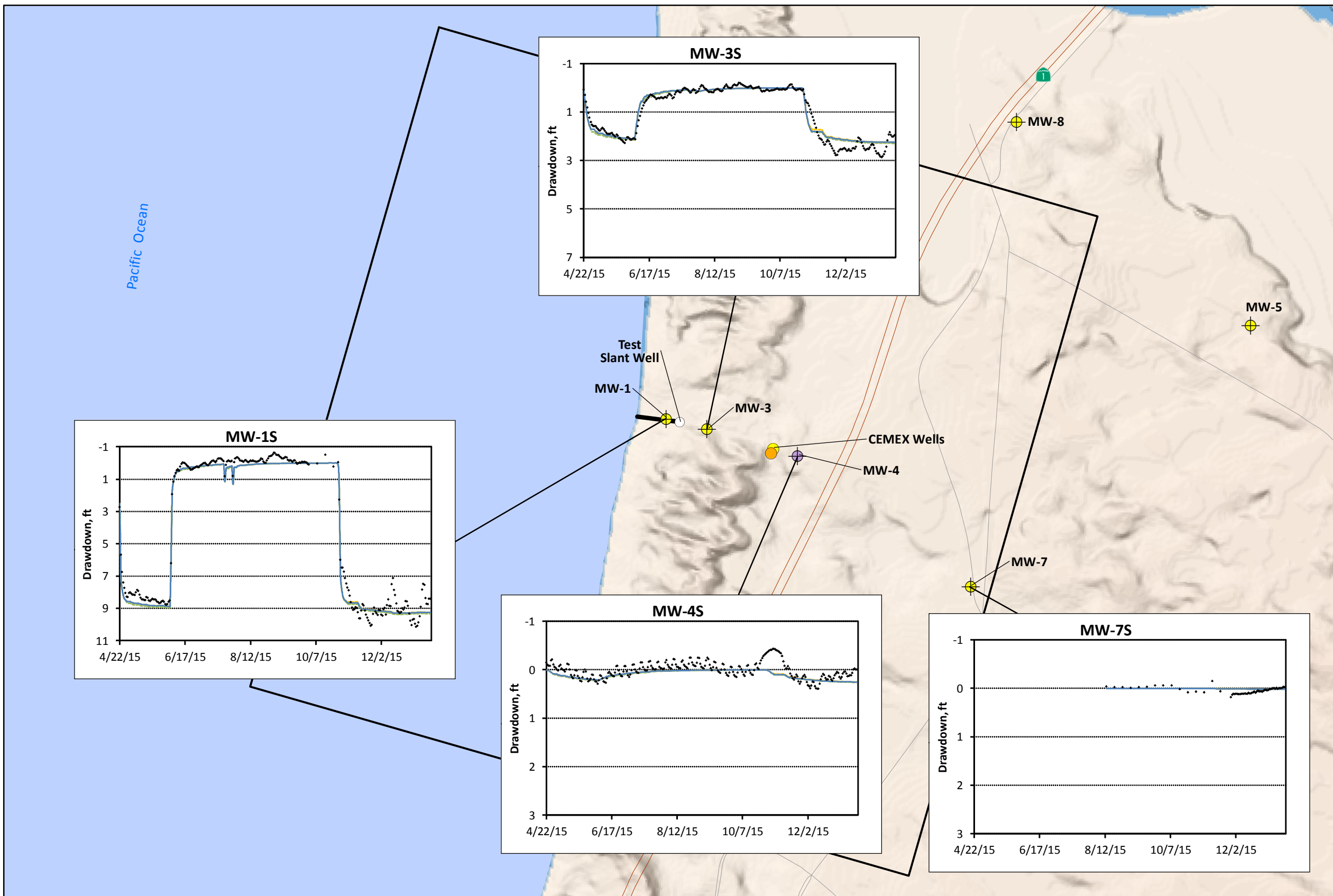


GEOSCIENCE

GEOSCIENCE Support Services, Inc.
P.O. Box 220, Claremont, CA 91711
Tel: (909) 451-6650 Fax: (909) 451-6638
www.gssiwater.com

Figure 71b

**SELECTED HYDROGRAPHS
FOR DUNE SAND AQUIFER -
SENSITIVITY RUN
VERTICAL HYDRAULIC
CONDUCTIVITY OF
OCEAN FLOOR SEDIMENTS**



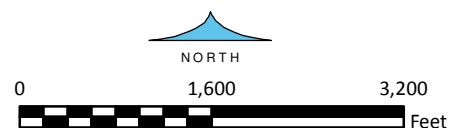
EXPLANATION

- CEMEX Model Boundary
- Monitoring Well Cluster
- Compliance Monitoring Well Cluster
- CEMEX Well - Inactive (Monitored)
- CEMEX Well - Active (Not Monitored)
- Test Slant Well
- 10% Vert. Hydraulic Conductivity
- 1000% Vert. Hydraulic Conductivity
- Calibration
- Observed

8-Feb-17

Prepared by: DB. Map Projection: State Plane 1983, Zone IV.

© 2017, GEOSCIENCE Support Services, Inc. All rights reserved.

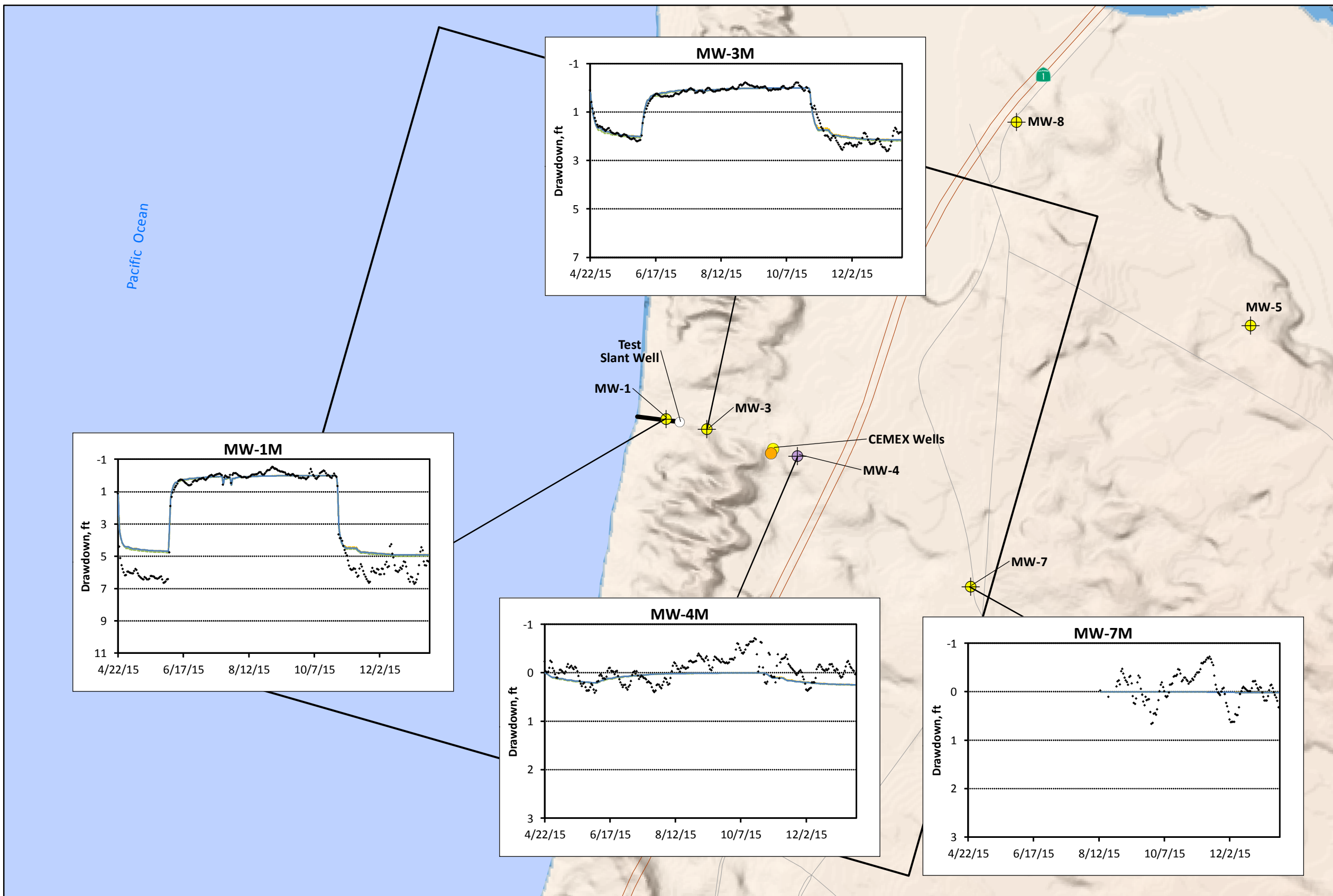


GEOSCIENCE

GEOSCIENCE Support Services, Inc.
P.O. Box 220, Claremont, CA 91711
Tel: (909) 451-6650 Fax: (909) 451-6638
www.gssiwater.com

Figure 72a

**SELECTED HYDROGRAPHS
FOR 180-FTE AQUIFER -
SENSITIVITY RUN
VERTICAL HYDRAULIC
CONDUCTIVITY OF
OCEAN FLOOR SEDIMENTS**



EXPLANATION

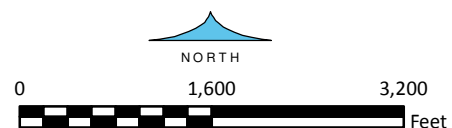
- CEMEX Model Boundary
- Monitoring Well Cluster
- Compliance Monitoring Well Cluster
- CEMEX Well - Inactive (Monitored)
- CEMEX Well - Active (Not Monitored)
- Test Slant Well

- 10% Vert. Hydraulic Conductivity
- 1000% Vert. Hydraulic Conductivity
- Calibration
- Observed

8-Feb-17

Prepared by: DB. Map Projection: State Plane 1983, Zone IV.

© 2017, GEOSCIENCE Support Services, Inc. All rights reserved.



GEOSCIENCE Support Services, Inc.
P.O. Box 220, Claremont, CA 91711
Tel: (909) 451-6650 Fax: (909) 451-6638
www.gssiwater.com

Figure 72b

W:\GIS_proj\mcwsp_cal_am\cal-am_CEMEX_model\Model_Calibration\10_Fig_72b_CEMEX_sens_hydrographs_180FTE_vert-hycon_oceansed_2-17.mxd

Summary of Calibration and Sensitivity Runs

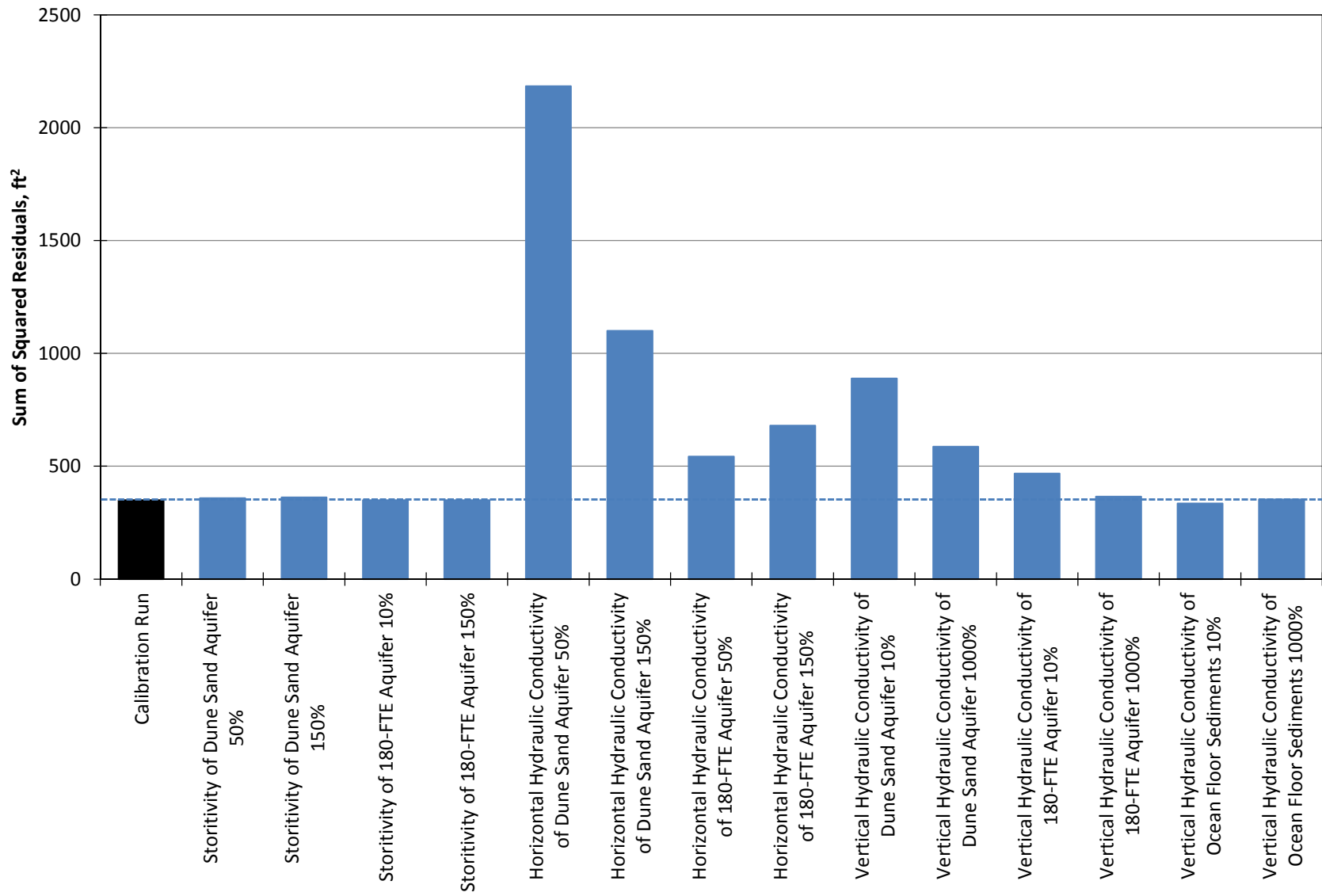


Figure 73

TABLES

Monitoring Well Information Table
State Plane Coordinates

Well Name	Date Drilling Began	Date of Well Completion	Cluster	Monitoring Well Diameter (in) ⁶	Reference Point (RP)	Survey Date	Northing	Easting	RP Elevation (ft) NAVD88	RP Height (ft ags)	Distance of RP from Slant Well Head (ft)	Top of Screen Interval (ft bgs)	Bottom of Screen Interval (ft bgs)	Screen Length (ft)	Total Depth ⁶ (ft)	Protective Cover Type	Transducer Installed Depth ⁷ (ft brp)
MW-1S	24-Jan-15	26-Jan-15	MW-1	4	Top of ABS Transducer Mount	26-Mar-15	2,154,745.35	5,739,355.82	30.51 ¹	2.65 ¹	211	55	95	40	98	Monument Stick Up	76
MW-1M	20-Jan-15	24-Jan-15	MW-1	4	Top of ABS Transducer Mount	26-Mar-15	2,154,751.93	5,739,347.94	29.86	2.48	220	115	225	110	228	Monument Stick Up	182
MW-1D	10-Dec-14	19-Dec-15	MW-1	4	Top of ABS Transducer Mount	26-Mar-15	2,154,753.60	5,739,337.98	29.68 ¹	2.65 ¹	230	277	327	50	337	Monument Stick Up	309
MW-3S	18-Feb-15	19-Feb-15	MW-3	4	Top of ABS Transducer Mount	26-Mar-15	2,154,599.85	5,739,977.02	37.16	2.66	428	50	90	40	92	Monument Stick Up	76
MW-3M	9-Feb-15	17-Feb-15	MW-3	4	Top of ABS Transducer Mount	26-Mar-15	2,154,592.96	5,739,988.54	37.35	2.73	441	105	215	110	230	Monument Stick Up	182
MW-3D	2-Feb-15	9-Feb-15	MW-3	4	Top of ABS Transducer Mount	26-Mar-15	2,154,589.81	5,739,998.68	36.93	2.74	451	285	330	45	333	Monument Stick Up	321
MW-4S	10-Feb-15	11-Feb-15	MW-4	4	Top of ABS Transducer Mount	26-Mar-15	2,154,170.90	5,741,427.62	41.96	2.25	1,940	60	100	40	105	Monument Stick Up	66
MW-4M	6-Feb-15	9-Feb-15	MW-4	4	Top of ABS Transducer Mount	26-Mar-15	2,154,172.79	5,741,416.78	41.99	2.15	1,929	130	260	130	266	Monument Stick Up	208
MW-4D	20-Dec-14	19-Jan-15	MW-4	4	Top of ABS Transducer Mount	26-Mar-15	2,154,174.30	5,741,406.08	41.95	2.15	1,918	290	330	40	333	Monument Stick Up	317
MW-5S(P)	28-Jan-15	2-Feb-15	MW-5	4	Top of ABS Transducer Mount	26-Mar-15	2,156,239.19	5,748,566.86	80.25 ¹	2.20 ¹	9,135	43	83	40	85	Monument Stick Up	71
MW-5M	21-Jan-15	27-Jan-15	MW-5	4	Top of ABS Transducer Mount	26-Mar-15	2,156,230.38	5,748,564.26	80.48 ¹	2.31 ¹	9,131	100	310	210	315	Monument Stick Up	171
MW-5D	16-Dec-14	21-Jan-15	MW-5	4	Top of ABS Transducer Mount	26-Mar-15	2,156,220.77	5,748,560.95	80.06	1.97	9,126	395	435	40	440	Monument Stick Up	417
MW-6S	20-Mar-15	21-Mar-15	MW-6	4	Top of ABS Transducer Mount	1-Oct-15	2,141,142.87	5,756,164.01	35.89	2.45 ¹	21,436	30	60	30	63	Monument Stick Up	61
MW-6M	10-Mar-15	20-Mar-15	MW-6	4	Top of ABS Transducer Mount	1-Oct-15	2,141,138.40	5,756,154.35	35.68	2.44 ¹	21,431	150	210	60	230	Monument Stick Up	103
MW-6M(L)	19-Feb-15	10-Mar-15	MW-6	4	Top of ABS Transducer Mount	1-Oct-15	2,141,133.06	5,756,144.94	35.82	2.42 ¹	21,427	255	325	70	340	Monument Stick Up	201

Monitoring Well Information Table
State Plane Coordinates

Well Name	Date Drilling Began	Date of Well Completion	Cluster	Monitoring Well Diameter (in) ⁶	Reference Point (RP)	Survey Date	Northing	Easting	RP Elevation (ft) NAVD88	RP Height (ft ags)	Distance of RP from Slant Well Head (ft)	Top of Screen Interval (ft bgs)	Bottom of Screen Interval (ft bgs)	Screen Length (ft)	Total Depth ⁶ (ft)	Protective Cover Type	Transducer Installed Depth ⁷ (ft brp)
MW-7S	22-Jul-15	23-Jul-15	MW-7	4	Top of ABS Transducer Mount	1-Oct-15	2,152,099.25	5,744,148.10	50.64	2.06	5,274	60	80	20	83	Monument Stick Up	72
MW-7M	13-Jul-15	22-Jul-15	MW-7	4	Top of ABS Transducer Mount	1-Oct-15	2,152,110.46	5,744,146.08	50.29	2.09	5,266	130	220	90	223	Monument Stick Up	187
MW-7D	27-Jun-15	13-Jul-15	MW-7	4	Top of ABS Transducer Mount	1-Oct-15	2,152,120.50	5,744,144.38	50.24	2.24	5,260	295	345	50	350	Monument Stick Up	322
MW-8S	12-May-15	13-May-15	MW-8	4	Top of ABS Transducer Mount	1-Oct-15	2,159,440.33	5,744,871.52	19.96	2.14 ³	7,116	40	80	40	84	Monument Stick Up	-
MW-8M	4-May-15	12-May-15	MW-8	4	Top of ABS Transducer Mount	1-Oct-15	2,159,430.86	5,744,866.05	19.99	2.17 ²	7,106	125	215	90	220	Monument Stick Up	181
MW-8D	14-Apr-15	3-May-15	MW-8	4	Top of ABS Transducer Mount	1-Oct-15	2,159,421.47	5,744,861.04	20.08	2.10 ³	7,096	300	350	50	360	Monument Stick Up	-
MW-9S	13-Jun-15	14-Jun-15	MW-9	4	Top of ABS Transducer Mount	1-Oct-15	2,162,010.77	5,747,345.03	18.42	2.16 ³	10,677	30	110	80	113	Monument Stick Up	-
MW-9M	3-Jun-15	13-Jun-15	MW-9	4	Top of ABS Transducer Mount	1-Oct-15	2,162,016.58	5,747,353.64	18.32	2.13 ²	10,687	145	225	80	227	Monument Stick Up	182
MW-9D	15-May-15	3-Jun-15	MW-9	4	Top of ABS Transducer Mount	1-Oct-15	2,162,022.89	5,747,362.25	18.32	2.15 ³	10,697	353	393	40	395	Monument Stick Up	-

Horizontal Datum: NAD83 State Plane Zone 4 ¹ RP/elevation change on May 17, 2015 - New caps MD: Measured Depth - lineal feet along the angle of the slant well

Vertical Datum: NAVD88 ² RP/elevation change on July 17, 2015 - New caps GS: Ground Surface - approximate ground surface elevation based on Google Earth

³ RP/elevation change on September 24, 2015 - New caps ⁴ Estimated - not surveyed ⁵ Filter Pack Material used CEMEX Lapis Lustre #3 gradation silica sand

⁶ Casing Type - Schedule 80 4" PVC, Difference between TD of borehole ⁷ Approximate Depth

Summary of Monitoring Well Laboratory Results - First Sampling Event

Constituent	Method	Units	Sample Date:																							
			13-Feb-15	14-Feb-15	14-Feb-15	25-Feb-15	24-Feb-15	21-Feb-15	7-Mar-15	6-Mar-15	19-Feb-15	10-Mar-15	8-Mar-15	17-Feb-15	5-Apr-15	4-Apr-15	2-Apr-15	3-Aug-15	2-Aug-15	9-Aug-15	28-May-15	27-May-15	21-May-15	30-Jun-15	28-Jun-15	25-Jun-15
Alkalinity, Total (as CaCO3)	SM2320B	mg/L	105	112	123	97	105	114	80	97	111	50	195	112	366	397	117	29	98	109	320	140	152	1051	127	170
Aluminum, Total	EPA 200.8	µg/L	ND	ND	ND	166	166	ND	ND	ND	ND	14	ND	ND	ND	ND	ND	18	ND	ND	292	37	11	ND	ND	
Ammonia-N, Dissolved	SM4500NH3 D	mg/L	ND	ND	ND	ND	ND	ND	ND	ND	ND	ND	ND	ND	0.45	0.17	ND	0.08	ND	ND	ND	ND	2.83	0.12	ND	
Arsenic, Total	EPA 200.8	µg/L	43	41	46	34	37	44	15	21	40	4	2	4	16	5	3	1	4	41	1	28	1	11	39	2
Barium, Dissolved	EPA 200.8	µg/L	68	61	141	97	79	162	92	104	166	173	96	562	105	155	255	199	282	110	57	154	88	315	163	59
Bicarbonate (as HCO3-)	SM2320B	mg/L	128	137	150	118	128	139	98	118	135	61	238	137	447	484	143	35	120	133	390	171	185	1282	155	207
Boron, Dissolved	EPA 200.7	mg/L	2.27	2.36	0.89	2.2	1.01	1.06	0.790	1.16	0.65	ND	ND	0.09	ND	ND	ND	ND	ND	1.71	0.22	1.83	0.05	0.69	2.93	0.08
Bromide, Dissolved	EPA 300.0	mg/L	39	46	44	44.8	53.8	44.1	16.7	31	43.8	4.4	0.4	3.3	0.2	0.5	2	1.3	6.6	44.3	0.9	42.1	0.6	4.2	49.6	0.2
Calcium	EPA 200.7	mg/L	661	746	2440	628	826	2470	594	1040	2980	129	96	360	93	139	341	120	507	1900	149	1110	64	209	878	32
Calcium, Dissolved	EPA 200.7	mg/L	646	732	2410	666	844	2370	617	1060	3070	142	99	363	92	140	347	114	520	1890	151	1140	59	242	869	35
Carbamates by HPLC (EPA 531)	EPA 531	µg/L	ND	ND	ND	ND	ND	ND	ND	ND	ND	ND	ND	ND	ND	ND	ND	ND	ND	ND	ND	ND	ND	ND	ND	ND
Carbonate as CaCO3	SM2320B	mg/L	ND	ND	ND	ND	ND	ND	ND	ND	ND	ND	ND	ND	ND	ND	ND	ND	ND	ND	ND	ND	ND	ND	ND	ND
Chloride, Dissolved	EPA 300.0	mg/L	14504	16037	14905	11680	14686	16069	5497	9751	14142	271	120	1168	57	167	814	387	1739	13589	261	12380	220	1199	16519	74
Color, Apparent (Unfiltered)	SM2120B	Color Units	4	ND	10	ND	ND	6	3	4	8	7	ND	ND	20	16	5	ND	ND	ND	3	ND	11	175	6	ND
Copper, Total	EPA 200.8	µg/L	62	61	40	42	62	56	ND	42	46	5	ND	13	ND	ND	8	ND	ND	ND	ND	ND	ND	ND	ND	10
DBCP & EDB	EPA 504.1	µg/L	ND	ND	ND	ND	ND	ND	ND	ND	ND	ND	ND	ND	ND	ND	ND	ND	ND	ND	ND	ND	ND	ND	ND	ND
Diquat (EPA 549)	EPA 549	µg/L	ND	ND	ND	ND	ND	ND	ND	ND	ND	ND	ND	ND	ND	ND	ND	ND	ND	ND	ND	ND	ND	ND	ND	ND
Dissolved Anions	Calculation	Meq/L	451.35	498.35	464.72	364.38	457.96	498.99	172.17	302.13	437.12	16.66	10.72	36.50	10.76	16.33	27.13	15.98	55.01	425.36	21.12	388.93	9.95	59.28	516.84	6.05
Dissolved Cations	Calculation	Meq/L	444.93	493.92	486.32	344.26	432.55	491.63	185.77	303.98	440.77	17.95	10.89	35.32	11.29	17.34	27.74	15.78	56.88	463.32	23.37	400.61	10.83	56.22	504.79	5.87
Fluoride, Dissolved	EPA 300.0	mg/L	0.3	ND	ND	0.4	0.5	ND	ND	ND	ND	ND	0.1	0.1	0.2	ND	0.1	0.1	ND	ND	0.1	0.4	0.3	ND	ND	0.3
Hardness (as CaCO3)	SM2340B/Calc	mg/L	5678	6327	10765	5044	6378	12063	3176	5601	11617	561	367	1484	393	565	1222	547	2044	9030	578	6080	263	1218	6718	133
Hydroxide	SM2320B	mg/L	ND	ND	ND	ND	ND	ND	ND	ND	ND	ND	ND	ND	ND	ND	ND	ND	ND	ND	ND	ND	ND	ND	ND	ND
Iodide	EPA 9056M	µg/L	ND	ND	ND	ND	ND	ND	ND	ND	ND	ND	ND	ND	35	35	ND	ND	ND	ND	ND	ND	ND	500	ND	ND
Iron	EPA 200.7	µg/L	25	ND	146	ND	ND	169	ND	ND	77	ND	ND	39	315	184	77	33	ND	ND	104	ND	81	6964	670	10
Iron, Dissolved	EPA 200.7	µg/L	15	12	118	ND	ND	142	ND	ND	80	ND	ND	351	182	ND	26	ND	ND	99	ND	15	6300	667	ND	
Kjeldahl Nitrogen, Dissolved	SM4500-NH3 B,C,E	mg/L	ND	ND	ND	ND	ND	ND	ND	ND	1.8	0.6	ND	ND	1.0	0.7	ND	0.09	ND	ND	ND	ND	6.12	0.20	ND	
Lithium	EPA 200.8	µg/L	172	201	254	144	159	250	16	34	222	6	7	75	6	17	25	5	29	271	ND	132	49	23	289	38
Magnesium	EPA 200.7	mg/L	978	1080	1130	844	1050	1430	411	730	1020	58	31	142	39	53	90	60	189	1040	50	801	25	169	1100	13
Magnesium, Dissolved	EPA 200.7	mg/L	979	1100	1180	797	1020	1290	421	752	979	62	31	135	37	49	83	58	192	1010	51	828	23	161	1090	13
Manganese, Dissolved	EPA 200.7	µg/L	41	18	440	ND	ND	259	ND	113	268	ND	ND	340	2090	821	714	476	372	230	ND	353	283	4920	1120	247
Manganese, Total	EPA 200.7	µg/L	43	19	484	58	14	289	ND	90	276	ND	ND	336	1880	810	750	500	372	232	ND	354	310	5140	1160	254
MBAS (Surfactants)	SM5540C	mg/L	ND	ND	ND	ND	ND	ND	ND	ND	ND	ND	ND	ND	ND	ND	ND	ND	ND	ND	ND	ND	ND	ND	ND	ND
Nitrate as NO3	EPA 300.0	mg/L	3	2	1	29	5	ND	20	4	1	237	70	3	ND	ND	2	198	15	6	123	5	2	ND	5	2
Nitrate+Nitrite as N	EPA 300.0	mg/L	0.7	1.1	0.4	6.5	1.2	0.1	5.3	1.0	0.2	54.0	16.2	0.8	0.5	0.5	0.7	44.8	3.4	1.4	28.2	1.5	0.7	2.5	1.2	0.9
Nitrite as NO2-N, Dissolved	EPA 300.0	mg/L	ND	0.6	0.2	ND	ND	ND	ND	ND	ND	ND	0.3	ND	0.5	0.1	0.2	0.1	ND	ND	0.4	0.4	0.3	2.5	ND	0.3
Odor Threshold at 60 C	SM2150B	TON	1	1	1	5	3	3	4	1	3	2	2	3	2	1	2	2	2	1	2	1	1	2	1	1
o-Phosphate-P	Hach 8048	mg/L	0.07	0.07	0.03	0.18	0.05	0.06	0.06	ND	0.06	0.05	0.06	0.04	1.55	0.32	0.05	0.035	0.016	0.05	0.10	0.06	0.06	1.34	0.06	0.06
pH (Field Test)	SM4500-H+B	pH	7.15	7.02	6.72	7.25	6.89	6.55	6.77	6.78	6.65	6.46	7.23	7.00	7.07	7.43	7.24	7.05	7.17	6.77	7.13	6.67	7.33	7.06	6.84	7.44
pH (Laboratory)	SM4500-H+B	pH (H)	7.2	7.0	7.1	7.2	7.2	6.9	7.0	7.1	7.0	6.7	7.3	7.5	7.1	7.4	7.4	7.3	7.2	6.9	7.4	7.2	7.6	7.1	6.9	7.5
Phosphorus, Dissolved Total	HACH 8190	mg/L	0.05	0.09	0.04	0.12	ND	0.04	0.06	ND	0.11	0.08	0.06	0.04	1.38	0.31	0.05	0.040	0.017	0.02	0.11	0.07	0.06	-	-	-
Potassium	EPA 200.7	mg/L	228	201	60	168	197	64.4	26	46	51.2	2.0	3.4	7.8	7.6	6.4	7.1	5.9	10	57	4.1	108	5.1	14	197	3.5
Potassium, Dissolved	EPA 200.7	mg/L	224	197	59	157	197	55.7	28.0	50.0	49.1	2.40	3.60	7.10	7.2	7.0	8.0	5.5	10	55	4.3	111	4.6	12.8	196	3.6
QC Ratio TDS/SEC	Calculation		0.68	0.70	0.73	0.68	0.69	0.74	0.70	0.68	0.72	0.67	0.60	0.69	0.61	0.63	0.67	0.68	0.68	0.69	0.62	0.69	0.56	0.60	0.66	0.59
Reg. Org. Compounds (EPA 525)	EPA 525	µg/L	ND	ND	ND	ND	ND	ND	ND	ND	ND	ND	ND	ND	ND	ND	ND	ND	ND	ND	ND	ND	ND	ND	ND	ND
Silica as SiO2, Dissolved	EPA 200.7	mg/L	20	22	33	19	21	32	27	30	36	39	35	32	44	44	37	30	35	37	30	45	43	35	45	
Sodium	EPA 200.7	mg/L	7306	8011	5760	5340	7232	6960	2579	4079	4286	120	71	161	79	140	77	124	338	6834	262	6106	148	732	8407	68
Sodium, Dissolved	EPA 200.7	mg/L	7500	8320	6150	5550	6930	6110	2750	4320	4730	131	76	136	79	141	78	119	342	6540	265	6270	135	698	8430	68
Specific Conductance (E.C)	SM2510B	µmhos/cm	39090	43960	40120	34180	41090	44020	17050	26250	38000	1752	1106	3775	989	1545	2758	1768	5650	38800	2036	35020	1045	5330	44090	624
Specific Conductance (E.C) (Field)	SM2510B	µmhos/cm	39747	43788	40882	33456	42340	41740	16917	26779	5750	1828	962	3961	869	1531	2859	1762	5507	39065	2004	35040	1113	5384	44462	574
Strontium, Dissolved	EPA 200.8	µg/L	7995	8689	15666	7619	9500	16370	5208	9637	17499	1231	630	2777	561	761	1826	1327	3689	12676	868	8504	470	3064	8148	273
Sulfate, Dissolved	EPA 300.0	mg/L	-	-	-	1533	1960	2058	716	1184	-	197	110	-	87	175	85	61	176	1882	258	1743	32	210	2286	25
Temperature (Field)	SM2550	°C	18.8	17.2	19.2	17.5	16.3	19.6	17.7	18.4	19.9	16.7	16.97	21.3	3.0	16.8	10.6	18.2	18.4	19.7	16.83	17.17	21.2	17.3	17.2	21.2
Total Anions	Calculation	Meq/L	451.35	498.35	464.72	364.38	457.96	498.99	172.17	302.13	437.12	16.66	10.72	36.50	10.76	16.33	27.13	15.98	55.01	425.36	21.12	388.93	9.95	59.28	516.84	6.05
Total Cations	Calculation	Meq/L																								

GEOSCIENCE



GEOSCIENCE Support Services, Inc. | P (909) 451-6650 | F (909) 451-6638
620 Arrow Highway, Suite 2000, La Verne, CA 91750 | Mailing: P.O. Box 220, Claremont, CA 91711

Monterey Peninsula Water Supply Project Hydrogeologic Investigation

Technical Memorandum (TM2) Monitoring Well Completion Report and CEMEX Model Update

Part 2 of 2:
Appendices

PREPARED FOR:
California American Water

February 8, 2017

GEOSCIENCE Support Services, Inc., **Ground Water Resources Development**
P.O. Box 220, Claremont, CA 91711 | P (909) 451-6650 | F (909) 451-6638 | www.gssiwater.com



APPENDICES

Ltr.	Description
A	Coastal Development Permit
B	County Well Permits
C	Monitoring Well Information
D	Well Logs Used for Cross-Sections
E	Fort Ord Monitoring Wells – Water Levels used for Contours
F	Water Quality Data – Initial Samples following Development

APPENDIX A
Coastal Development Permit



CALIFORNIA COASTAL COMMISSION

45 FREMONT, SUITE 2000
SAN FRANCISCO, CA 94105-2219
VOICE (415) 904-5200
FAX (415) 904-5400
TDD (415) 597-5885

**COASTAL DEVELOPMENT PERMIT**

On November 12, 2014, by a vote of 11-0, the California Coastal Commission granted to California American Water Company (Cal-Am) Coastal Development Permit #A-3-MRA-14-0050 subject to the attached standard and special conditions, for development consisting of:

Construction, operation, and decommissioning of a test slant well at the CEMEX sand mining facility in the City of Marina and beneath Monterey Bay in the County of Monterey.

Issued on behalf of the Coastal Commission on December 8, 2014.

CHARLES LESTER
Executive Director

A handwritten signature in cursive script, appearing to read "Alison J. Dettmer".

By: ALISON J. DETTMER
Deputy Director
Energy, Ocean Resources, and Federal Consistency Division

Permit A-3-MRA-14-0050

December 8, 2014

Page 2 of 12

Acknowledgment:

The undersigned Permittee acknowledges receipt of this permit and agrees to abide by all terms and conditions thereof.

The undersigned Permittee acknowledges that Government Code Section 818.4, which states in pertinent part, that: "A public entity is not liable for injury caused by the issuance... of any permit..." applies to the issuance of this permit.

IMPORTANT: THIS PERMIT IS NOT VALID UNLESS AND UNTIL A COPY OF THE PERMIT WITH THE SIGNED ACKNOWLEDGMENT HAS BEEN RETURNED TO THE COMMISSION OFFICE (14 Cal. Admin. Code Section 13158(a).)

12/8/14
Date


Signature of Permittee or Representative

STANDARD CONDITIONS

This permit is subject to the following standard conditions:

1. **Notice of Receipt and Acknowledgment.** The permit is not valid and development shall not commence until a copy of the permit, signed by the Permittee or authorized agent, acknowledging receipt of the permit and acceptance of the terms and conditions, is returned to the Commission office.
2. **Expiration.** If development has not commenced, the permit will expire two years from the date on which the Commission voted on the application. Development shall be pursued in a diligent manner and completed in a reasonable period of time. Application for extension of the permit must be made prior to the expiration date.
3. **Interpretation.** Any questions of intent of interpretation of any condition will be resolved by the Executive Director or the Commission.
4. **Assignment.** The permit may be assigned to any qualified person, provided assignee files with the Commission an affidavit accepting all terms and conditions of the permit.
5. **Terms and Conditions Run with the Land.** These terms and conditions shall be perpetual, and it is the intention of the Commission and the Permittee to bind all future owners and possessors of the subject property to the terms and conditions.

SPECIAL CONDITIONS

This permit is subject to the following special conditions:

1. **Proof of Legal Interest and Other Approvals.** The Permittee shall provide to the Executive Director a copy of each of the following approvals or documentation from the relevant agency that such approval is not required:
 - a. PRIOR TO PERMIT ISSUANCE, proof of legal interest in the project site.
 - b. PRIOR TO CONNECTING TO THE OUTFALL, the negotiated agreement or memorandum of understanding between the applicant and the Monterey Regional Water Pollution Control Agency (“MRWPCA”) regarding connection and use of the ocean outfall for discharge of water produced from the test well.
 - c. PRIOR TO ISSUANCE OF CDP 9-14-1735, a lease from the State Lands Commission.

The Permittee shall inform the Executive Director of any changes to the project required by, or resulting from, these permits or approvals. Such changes shall not be incorporated into the project until the Permittee obtains a Commission amendment to this permit, unless the Executive Director determines that no amendment is legally required.

2. **Liability for Costs and Attorneys Fees.** The Permittee shall reimburse the Coastal Commission in full for all Coastal Commission costs and attorneys fees – including (a) those charged by the Office of the Attorney General; and (b) any court costs and attorneys fees that the Coastal Commission may be required by a court to pay – that the Coastal Commission incurs in connection with the defense of any action brought by a party other than the Permittee against the Coastal Commission, its officers, employees, agents, successors, and assigns challenging the approval or issuance of this permit, the interpretation and/or enforcement of permit conditions, or any other matter related to this permit. The Coastal Commission retains complete authority to conduct and direct the defense of any such action against the Coastal Commission.

3. **Project Construction.** The Permittee shall conduct project construction as described and conditioned herein, including the following measures:
 - a. Project-related construction shall occur only in areas as described in the permit application.
 - b. Project-related construction, including site preparation, equipment staging, and installation or removal of equipment or wells, occurring between February 28 and October 1 of any year is subject to the timing and species protection requirements of Special Condition 14.
 - c. Construction equipment and materials, including project-related debris, shall be placed or stored where it cannot enter a storm drain or coastal waters. The Permittee shall ensure that all construction personnel keep all food-related trash items in sealed containers and remove them daily to discourage the concentration of potential predators in snowy plover habitat. All trash and construction debris shall be removed from work areas and properly disposed of at the end of each work day at an approved upland location. All vegetation removed from the construction site shall be taken to a certified landfill to prevent the spread of invasive species.
 - d. To reduce construction noise, noise attenuation devices (e.g., noise blankets, sound baffles, etc.) shall be installed around all stationary construction equipment, including drill rigs.
 - e. All project vehicles shall maintain speeds of 10 miles per hour or less when at the project site. Prior to moving any vehicle, project personnel shall visually inspect for special-status species under and around the vehicle, and shall notify the on-site biologist should any be detected.
 - f. To avoid predation of special-status species, wire excluders or similar anti-perching devices shall be installed and maintained on the top of all aboveground structures (e.g., electrical panel) to deter perching by avian predators.

No changes to these requirements shall occur without a Commission amendment to this permit unless the Executive Director determines that no amendment is legally required.

4. **Protection of Water Quality.** PRIOR TO COMMENCEMENT OF CONSTRUCTION, the Permittee shall submit an erosion control plan for Executive Director review and approval. The Plan shall include a schedule for the completion of erosion- and sediment-control structures, which ensures that all such erosion-control structures are in place by mid-November of the year that construction begins and maintained thereafter. The plan

shall identify standard Best Management Practices to be implemented to address both temporary and permanent measures to control erosion and reduce sedimentation. Site monitoring by the applicant's erosion-control specialist shall be undertaken and a follow-up report shall be prepared that documents the progress and/or completion of required erosion-control measures both during and after construction and decommissioning activities. No synthetic plastic mesh products shall be used in any erosion control materials. All plans shall show that sedimentation and erosion control measures are installed prior to any other ground disturbing work.

5. Hazardous Material Spill Prevention and Response.

(a) PRIOR TO COMMENCEMENT OF CONSTRUCTION, the Permittee shall submit for Executive Director review and approval a project-specific Hazardous Materials Spill Prevention and Response Plan that includes:

- an estimate of a reasonable worst case release of fuel or other hazardous materials onto the project site or into adjacent sensitive habitat areas or coastal waters resulting from project operations;
- all identified locations within the project footprint of known or suspected buried hazardous materials, including current or former underground storage tanks, septic systems, refuse disposal areas, and the like;
- specific protocols for monitoring and minimizing the use of fuel and hazardous materials during project operations, including Best Management Practices that will be implemented to ensure minimal impacts to the environment;
- a detailed response and clean-up plan in the event of a spill or accidental discharge or release of fuel or hazardous materials;
- a list of all spill prevention and response equipment that will be maintained on-site;
- the designation of the onsite person who will have responsibility for implementing the plan;
- a telephone contact list of all regulatory and public trustee agencies, including Coastal Commission staff, having authority over the development and/or the project site and its resources to be notified in the event of a spill or material release; and,
- a list of all fuels and hazardous materials that will be used or might be used during the proposed project, together with Material Safety Data Sheets for each of these materials.

The Permittee shall implement the Plan as approved by the Executive Director. The Permittee shall also ensure that all onsite project personnel participate in a training program that describes the above-referenced Plan, identifies the Plan's requirements for implementing Best Management Practices to prevent spills or releases, specifies the location of all clean-up materials and equipment available on site, and specifies the measures that are to be taken should a spill or release occur.

- (b) In the event that a spill or accidental discharge of fuel or hazardous materials occurs during project construction or operations, all non-essential project construction and/or operation shall cease and the Permittee shall implement spill response measures of the approved Plan, including notification of Commission staff. Project construction and/or operation shall not start again until authorized by Commission staff.
- (c) If project construction or operations result in a spill or accidental discharge that causes adverse effects to coastal water quality, ESHA, or other coastal resources, the Permittee shall submit an application to amend this permit, unless the Executive Director determines no amendment is required. The application shall identify proposed measures to prevent future spills or releases and shall include a proposed restoration plan for any coastal resources adversely affected by the spill or release.

The Permittee shall implement the Plan as approved by the Executive Director.

6. **Monitoring and Removal of Temporary Structures, Well Head Burial & Well Closure/Destruction.** The Permittee shall monitor beach erosion at least once per week over the duration of the project to ensure the slant well and monitoring wells remain covered. If the wellheads, linings, casings, or other project components become exposed due to erosion, shifting sand or other factors, the Permittee shall immediately take action to reduce any danger to the public or to marine life and shall submit within one week of detecting the exposed components a complete application for a new or amended permit to remedy the exposure.

Upon project completion, and no later than February 28, 2018, the Permittee shall cut off, cap, and bury the slant well head at least 40 feet below the ground surface, and shall completely remove all other temporary facilities approved by this coastal development permit. To ensure timely removal, the Permittee shall post the bond or other surety device as required by **Special Condition 17** to ensure future removal measures would be appropriately supported and timed to prevent any future resurfacing of the well casing or other project components.

7. **Assumption of Risk, Waiver of Liability and Indemnity.** By acceptance of this permit, the Permittee acknowledges and agrees:
- a. that the site may be subject to hazards from coastal erosion, storm conditions, wave uprush, and tsunami runup;
 - b. to assume the risks to the Permittee and the property that is the subject of this permit of injury and damage from such hazards in connection with this permitted development;
 - c. to unconditionally waive any claim of damage or liability against the Commission, its officers, agents, and employees for injury or damage from such hazards; and
 - d. to indemnify and hold harmless the Commission, its officers, agents, and employees with respect to the Commission's approval of the project against any and all liability, claims, demands, damages, costs (including costs and fees incurred in defense of such claims), expenses, and amounts paid in settlement arising from any injury or damage due to such hazards.

8. **No Future Shoreline Protective Device.** By acceptance of this permit, the Permittee agrees, on behalf of itself and all other successors and assigns, that no shoreline protective device(s) shall ever be constructed to protect the development approved pursuant to this permit, including the wells, supporting infrastructure, and any future improvements, in the event that the development is threatened with damage or destruction from waves, erosion, storm conditions or other natural hazards in the future. By acceptance of this permit, the Permittee hereby waives, on behalf of itself and all successors and assigns, any rights to construct such devices that may exist under Public Resources Code Section 30235.

By acceptance of this permit, the Permittee further agrees, on behalf of itself and all successors and assigns, that the Permittee shall remove the development authorized by this permit, including the wells, supporting infrastructure, and any future improvements, if any government agency with the requisite jurisdiction and authority has ordered, and the Executive Director has concurred, that the development is not to be used due to any of the hazards identified in **Special Condition 7**. In the event that portions of the development fall to the beach before they are removed, the Permittee shall remove all recoverable debris associated with the development from the beach and ocean and lawfully dispose of the material in an approved disposal site. Such removal shall require a coastal development permit.

9. **Geology/Hazards.** The project shall be designed to meet or exceed all applicable requirements of the California Building Code. Project design and construction shall meet or exceed all applicable feasible conclusions and recommendations in the *Geotechnical Investigation for the California American Water Temporary Slant Test Well Project, Marina, Monterey County, California*, dated April 3, 2014 (GeoSoils 2014). Project components shall be sited to avoid areas identified in the coastal erosion memorandum prepared by ESA-PWA (March 2014) as subject to coastal erosion during the duration of the project.
10. **Visual Resources.** PRIOR TO PERMIT ISSUANCE, the Permittee shall submit for Executive Director review and approval a Lighting Plan prepared by a qualified engineer that includes the following:
- a. Identifies all lighting and associated infrastructure proposed for use during the test well project, such as towers, poles, electrical lines, etc. The Lighting Plan shall identify the locations, heights, dimensions, and intensity of the lighting and associated lighting infrastructure.
 - b. Evaluates the effects of project lighting and associated infrastructure on wildlife in the project area and describes proposed measures to avoid or minimize any adverse effects. These measures may include shielding project lighting from off-site locations, directing lighting downward, using the minimum amount of lighting necessary to ensure project safety, and other similar measures.
 - c. Affirms that all lighting structures and fixtures installed for use during the project and visible from public areas, including shoreline areas of Monterey Bay, will be painted or finished in neutral tones that minimize their visibility from those public areas.
- The Permittee shall implement the Lighting Plan as approved by the Executive Director.

11. Protection of Nearby Wells. PRIOR TO STARTING PROJECT-RELATED PUMP TESTS, the Permittee shall install monitoring devices a minimum of four wells on the CEMEX site, within 2000 feet of the test well, and one or more offsite wells to record water and salinity levels within the wells and shall provide to the Executive Director the baseline water and Total Dissolved Solids (“TDS”) levels in those wells prior to commencement of pumping from the test well. The Hydrogeology Working Group shall establish the baseline water and TDS levels for the monitoring wells. During the project pump tests, the Permittee shall, at least once per day, monitor water and TDS levels within those wells in person and/or with electronic logging devices. The Permittee shall post data collected from all monitoring wells on a publicly-available internet site at least once per week and shall provide all monitoring data to the Executive Director upon request. If water levels drop more than one-and-one-half foot, or if TDS levels increase more than two thousand parts per million from pre-pump test conditions, the Permittee shall immediately stop the pump test and inform the Executive Director. The Hydrogeology Working Group shall examine the data from Monitoring Well 4 if the test well is shut down due to either of these causes. The Hydrogeology Working Group shall determine whether the drop in water level or increase in TDS is from a cause or causes other than the test well, and it will submit its determination to the Executive Director. If the Executive Director agrees with the Hydrogeology Working Group that the cause of the drop in water level or increase in TDS was a source or sources other than the test well, then the Executive Director may allow testing to resume. If, however, the Executive Director determines that the drop in water level was caused at least in part by the test well, then the Permittee shall not re-start the pump test until receiving an amendment to this permit.

12. Protection of Biological Resources – Biological Monitor(s). PRIOR TO COMMENCEMENT OF CONSTRUCTION, the Permittee shall retain one or more qualified biologists approved by the Executive Director to ensure compliance with all relevant mitigation measures and Special Conditions. The approved biologist(s) shall conduct the required preconstruction surveys, implement ongoing monitoring and inspections, keep required records, and notify Commission staff and staff of other agencies as necessary regarding project conformity to these measures and Special Conditions.

The approved biologist(s) shall be present during daylight hours for all project construction and decommissioning activities and on a periodic basis when the biologist determines operational activities may affect areas previously undisturbed by project activities. The biologist(s) shall monitor construction equipment access and shall have authority to halt work activities, if the potential for impacts to special-status species or habitat is identified, until the issue can be resolved. The qualified biologist(s) shall immediately report any observations of significant adverse effects on special-status species to the Executive Director.

- 13. Protection of Biological Resources – Training of On-site Personnel.** Prior to starting construction and decommissioning activities, the approved biologist(s) shall conduct an environmental awareness training for all construction personnel that are on-site during activities. The training shall include, at a minimum, the following:
- Descriptions of the special-status species with potential to occur in the project area;
 - Habitat requirements and life histories of those species as they relate to the project;
 - Avoidance, minimization, and mitigation measures that will be implemented to avoid impacts to the species and their habitats;
 - Identification of the regulatory agencies and regulations that manage their protection; and,
 - Consequences that may result from unauthorized impacts or take of special-status species and their habitats.

The training shall include distribution of an environmental training brochure, and collection of signatures from all attendees acknowledging their participation in the training. Subsequent trainings shall be provided by the qualified biologist as needed for additional construction or operations workers through the life of the project.

14. Protection of Biological Resources – Pre-Construction and Pre-Disturbance

Surveys. The approved biologist(s) shall conduct pre-construction surveys for special-status species as described below:

- a. No more than 14 days before the start of onsite activities or any activities planned for areas previously undisturbed by project activities, the biologist(s) shall conduct a field evaluation of the nature and extent of Western snowy plover activity in the project area and shall identify measures needed to ensure construction activities minimize potential effects to the species. Those measures shall, at a minimum, meet the standards and requirements of the mitigation measures included in Exhibit 5 as well as those included in subsection (d) of this special condition. Those measures shall also be submitted for Executive Director review and approval at least five days before the start of construction activities. The Permittee shall implement the measures as approved by the Executive Director.
- b. Prior to construction or activities planned for areas previously undisturbed by project activities, the approved biologist(s) shall coordinate with construction crews to identify and mark the boundaries of project disturbance, locations of special-status species and suitable habitat, avoidance areas, and access routes. GPS data collected during preconstruction surveys completed in 2012, 2013, and 2014 shall be used to flag the known locations of Monterey spineflower and buckwheat for avoidance during construction. Avoidance buffers shall be established and flagged or fenced as necessary to avoid surface disturbance or vegetation removal. The monitoring biologist shall fit the placement of flags and fencing to minimize impacts to any sensitive resources. At a minimum, the biologist shall direct the placement of highly visible exclusion fencing (snow fence or similar) at the following locations:
 - around sensitive snowy plover habitat areas that do not require regular access;
 - areas along the northern edge of the CEMEX accessway in the vicinity of the settling ponds; and
 - between the work area and any identified occurrence of Monterey spineflower or buckwheat within 10 feet of the existing accessway or work area.

- All delineated areas of temporary fencing shall be shown on grading plans and shall remain in place and functional throughout the duration of construction and decommissioning activities.
- c. The approved biologist(s) shall conduct surveys for Monterey spineflower and buckwheat (host plant for Smith's blue butterfly) within all project disturbance areas and within 20 feet of project boundaries during the blooming period for the spineflower (April-June) to identify and record the most current known locations of these species in the project vicinity. Surveys shall be conducted by a qualified botanist, and shall include collection of Global Positioning System (GPS) data points for use during flagging of sensitive plant species locations and avoidance buffers prior to construction.
 - d. Starting no later than February 1 of each year of project construction, operation, and decommissioning, the approved biologist(s) shall conduct breeding and nesting surveys of sensitive avian species within 500 feet of the project footprint. The approved biologist(s) shall continue those surveys at least once per week during periods of project construction, well re-packing, and decommissioning that occur between February 1 and October 1 each year.

In the event that any sensitive species are present in the project area but do not exhibit reproductive behavior and are not within the estimated breeding/reproductive cycle of the subject species, the qualified biologist shall either: (1) initiate a salvage and relocation program prior to any excavation/maintenance activities to move sensitive species by hand to safe locations elsewhere along the project reach or (2) as appropriate, implement a resource avoidance program with sufficient buffer areas to ensure adverse impacts to such resources are avoided. The Permittee shall also immediately notify the Executive Director of the presence of such species and which of the above actions are being taken. If the presence of any such sensitive species requires review by the United States Fish and Wildlife Service and/or the California Department of Fish and Game, then no development activities shall be allowed or continue until any such review and authorizations to proceed are received and also authorizes construction to proceed.

If an active nest of a federally or state-listed threatened or endangered species, species of special concern, or any species of raptor or heron is found, the Permittee shall notify the appropriate State and Federal wildlife agencies within 24 hours, and shall develop an appropriate action specific to each incident. The Permittee shall notify the California Coastal Commission in writing by facsimile or e-mail within 24 hours and consult with the Commission regarding determinations of State and Federal agencies.

If the biologist(s) identify an active nest of any federally- or state-listed threatened or endangered species, species of special concern, or any species of raptor or heron within 300 feet of construction activities (500 feet for raptors), the biologist(s) shall monitor bird behavior and construction noise levels. The biologist(s) shall be present at all relevant construction meetings and during all significant construction activities (those with potential noise impacts) to ensure that nesting birds are not disturbed by

construction-related noise. The biologist(s) shall monitor birds and noise every day at the beginning of the project and during all periods of significant construction activities. Construction activities may occur only if construction noise levels are at or below a peak of 65 dB at the nest(s) site. If construction noise exceeds a peak level of 65 dB at the nest(s) site, sound mitigation measures such as sound shields, blankets around smaller equipment, mixing concrete batches off-site, use of mufflers, and minimizing the use of back-up alarms shall be employed. If these sound mitigation measures do not reduce noise levels, construction within 300 ft. (500 ft. for raptors) of the nesting areas shall cease and shall not re-start until either new sound mitigation can be employed or nesting is complete.

If active plover nests are located within 300 feet of the project or access routes, avoidance buffers shall be established to minimize potential disturbance of nesting activity, and the biologist shall coordinate with and accompany the Permittee's operational staff as necessary during the nesting season to guide access and activities to avoid impacts to nesting plovers. The biologist shall contact the USFWS and CDFW immediately if a nest is found in areas near the wellhead that could be affected by project operations. Operations shall be immediately suspended until the Permittee submits to the Executive Director written authorization to proceed from the USFWS.

If, after starting project activities, the Permittee must stop construction due to the presence of sensitive species or due to the lack of necessary approvals or permits (e.g., a lease from the State Lands Commission), the Permittee shall remove and properly store all project-related equipment and vehicles away from the project site in a manner that does not adversely affect sensitive species.

- 15. Project Area Restoration.** PRIOR TO COMMENCEMENT OF CONSTRUCTION, the Permittee shall prepare a Restoration Plan for review and approval by the Executive Director that is consistent with the City of Marina restoration requirements as codified in Municipal Code Section 17.41.100. The Plan shall include, at a minimum:
- a. a description of the habitat characteristics and extent of the area to be restored, which shall include, at a minimum, all areas of temporary disturbance in the project footprint other than those areas actively in use by CEMEX for mining purposes;
 - b. performance standards and success criteria to be used;
 - c. a minimum 3:1 ratio of native plants to be replaced within the affected area;
 - d. an invasive species control program to be implemented for the duration of the project;
 - e. the timing of proposed restoration activities;
 - f. proposed methods to monitor restoration performance and success for at least five years following initiation of the Plan; and
 - g. identification of all relevant conditions, requirements, and approvals by regulatory agencies needed to implement the Plan.

The Permittee shall implement the Plan: (1) during and immediately following construction and prior to operation of the test well, and (2) during and immediately following decommissioning activities.

Success criteria will include plant cover and species composition/diversity, which shall meet or exceed adjacent undisturbed dune habitat on the CEMEX parcel as determined by the biological monitor. Success criteria shall, at a minimum, be consistent with the requirements of the existing Lapis Revegetation Plan prepared for the RMC Lonestar Lapis Sand Plant (25 percent average vegetative cover and species diversity of all species listed in Group A of the Plan present and providing at least 1 percent cover).

16. **Invasive Species Control.** The Permittee shall remove and properly dispose of at a certified landfill all invasive or exotic plants disturbed or removed during project activities. The Permittee shall use existing on-site soils for fill material to the extent feasible. If the use of imported fill material is necessary, the imported material must be obtained from a source that is known to be free of invasive plant species, or the material must consist of purchased clean material.

17. **Posting of Bond.** To ensure timely removal, **PRIOR TO COMMENCEMENT OF CONSTRUCTION**, the Permittee shall provide to the Commission a surety bond or similar security device acceptable to the Executive Director for \$1,000,000 (one million dollars), and naming the Coastal Commission as the assured, to guarantee the Permittee's compliance with Special Conditions 6 and 15. The surety bond or other security device shall be maintained in full force and effect at all times until Special Conditions 6 and 15 have been met.

CALIFORNIA COASTAL COMMISSION

45 FREMONT, SUITE 2000
SAN FRANCISCO, CA 94105-2219
VOICE AND TDD (415) 904-5200
FAX (415) 904-5400



Page 1 of 3
October 13, 2015
Permit No. **A-3-MRA-14-0050-A1**

COASTAL DEVELOPMENT PERMIT AMENDMENT

On October 6, 2015, by a vote of 12-0, the California Coastal Commission granted to California American Water Company Coastal Development Permit Amendment No. A-3-MRA-14-0050-A1, subject to the attached standard and special conditions, for development consisting of:

Construction, operation, and decommissioning of a test slant well and associated monitoring wells, equipment, and infrastructure at the CEMEX sand mining facility.

The development is located in the coastal zone in the City of Marina, County of Monterey, and in the Commission's retained jurisdiction.

Issued on behalf of the Coastal Commission on October 13, 2015.

CHARLES LESTER
Executive Director

A handwritten signature in black ink, appearing to read "Charles Lester", written over the printed name and title.

for By: ALISON DETTMER
Deputy Director, Energy, Ocean Resources, and Federal Consistency Division

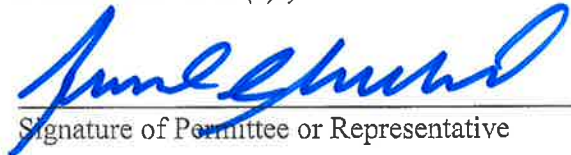
Acknowledgment:

The undersigned permittee(s) acknowledges receipt of this permit and agrees to abide by all terms and conditions thereof.

The undersigned permittee(s) acknowledges that Government Code Section 818.4, which states in pertinent part, that: "A public entity is not liable for injury caused by the issuance...of any permit..." applies to the issuance of this permit.

IMPORTANT: THE PERMIT IS NOT VALID UNLESS AND UNTIL A COPY OF THE PERMIT WITH THE SIGNED ACKNOWLEDGMENT HAS BEEN RETURNED TO THE COMMISSION OFFICE. (14 Cal. Admin. Code Section 13158(a).)

10/13/15
Date


Signature of Permittee or Representative

SPECIAL CONDITIONS

This **Special Condition** modifies **Special Condition 11** as initially imposed by the Commission in Coastal Development Permit A-3-MRA-14-0050. Standard Conditions 1-5 and Special Conditions 1-10 and 12-17 of that permit shall remain in full force and effect. **Special Condition 11** now requires:

“Protection of Nearby Wells. PRIOR TO STARTING PROJECT-RELATED PUMPING TESTS, the Permittee shall install monitoring devices at a minimum of four wells on the CEMEX site, within 2000 feet of the test well, and one or more offsite wells to record groundwater and salinity levels within the wells and shall provide to the Executive Director the baseline groundwater and Total Dissolved Solids (“TDS”) levels in those wells prior to commencement of pumping from the test well.

The Permittee, in coordination with the Hydrogeology Working Group, shall identify groundwater elevation trends and TDS level trends in the groundwater basin resulting from regional influences such as groundwater withdrawals, rainfall events, increases or decreases in streamflow contributions, and other influences. During the project pumping tests, the Permittee shall, at least once per day, monitor groundwater and TDS levels within the monitoring wells in person and/or with electronic logging devices. The Permittee shall post data collected from all monitoring wells on a publicly-available internet site at least once per week and shall provide all monitoring data to the Executive Director upon request.

The Hydrogeology Working Group shall review data from the monitoring wells and prepare a monthly report that shall be submitted to the Executive Director that documents the groundwater elevation trends and TDS level trends resulting from regional influences. If during the pumping tests, data collected from Monitoring Well-4S (“MW4-S”) or Monitoring Well-4M (“MW-4M”) during any weekly monitoring period show either a decrease in groundwater levels that exceeds an identified decrease in regional groundwater level trends by 1.5 feet or more or show an increase in TDS levels that exceeds an identified increase in regional TDS level trends by two thousand parts per million or more, the Permittee shall immediately stop the pumping test and inform the Executive Director. The Hydrogeology Working Group shall examine the data from Monitoring Well 4 if the pumping test is stopped due to either of these causes.

If, based on the above review of monitoring data, the Executive Director or the Hydrogeology Working Group determines that the pumping test caused, at MW-4S or MW4-M, either a decrease in groundwater level of 1.5 feet or more or caused an increase in TDS levels of two thousand parts per million or more in excess of identified regional trends, then the Permittee shall not re-start the pumping test until receiving an amendment to this permit; otherwise the Executive Director will allow the pumping test to resume.”

APPENDIX B
County Well Permits





MONITORING WELL PERMIT

PERMIT NO: 14-12453

-MONITORING WELL

-CONSTRUCTION

-PIEZOMETER

-DESTRUCTION

SITE LOCATION: Cemex Plant end of Lapis Rd (MW-1S, MW-1M, MW-1D)

APN #: 203-011-019-000

<p>SITE CONTACT PERSON: MARIO ROMERO</p> <p>PHONE: (909)946-1640</p>	<p>OWNER: CAL AM – IAN CROOKS 511 FOREST LODGE RD, STE 100 PACIFIC GROVE, CA 93950 PHONE: (831)646-3217</p>
<p>CONSULTANT:</p> <p>PHONE:</p>	<p>DRILLER: CASCADE DRILLING 1333 WEST 9TH STREET UPLAND, CA 91786 LICENSE #: C-57 938110 PHONE : (909)946-1640</p>

CONDITIONS:

1. All requirements set forth in Monterey Code Chapter 15.08 and Bulletins 74-81 and 74-90, shall be complied with at all times.
2. The well shall be at least 100 feet from any septic tank; any portion of any leach field or animal enclosure; 50 feet from any sewer main, line or lateral; and 150 feet from any seepage pit. If type of absorption field is unknown, the distance shall be 150 feet.
3. Location of the well shall not prevent the installation, relocation or expansion of the septic system on any adjoining lot.
4. Permit shall be kept on site at all times while work is in progress.
5. The well shall be drilled in the approved location delineated on the attached map, Exhibit A. The well cannot be drilled in any other location without prior approval from Monterey County Health Department, Environmental Health Bureau (EHB) and receipt of an amended permit.
6. The well shall be constructed per attached design, Exhibit B.
7. Any well on the premises which is to be abandoned, or which has been abandoned shall be properly destroyed within six months of the completion of this well.

8. Notify the EHB at least 24 hours prior to moving on site.
9. Notify the EHB 24 hours prior to the time you expect to place any seal.
10. The sealing material shall be neat cement.
11. If the seal(s) cannot be witnessed by the EHB, a detailed, written description of the seal(s) shall be submitted to the EHB within ten days.
12. Surface construction features of the completed well shall be in accordance with the California Well Standards Bulletin 74-81 and Bulletin 74-90 Section 10.
13. The permit applicants shall indemnify and hold harmless the County and its officers, agents, and employees from actions or claims of any description brought on account of any injury or damages sustained, by any person or property resulting from the issuance of the permit and the conduct of the activities authorized under said permit.
14. Issuance of this permit to construct a well does not create, transfer, assign or acknowledge any legal rights to water associated with this property.
15. Submit a Well Completion Report within 60 days upon completion.

DATE ISSUED: 11/21/2014

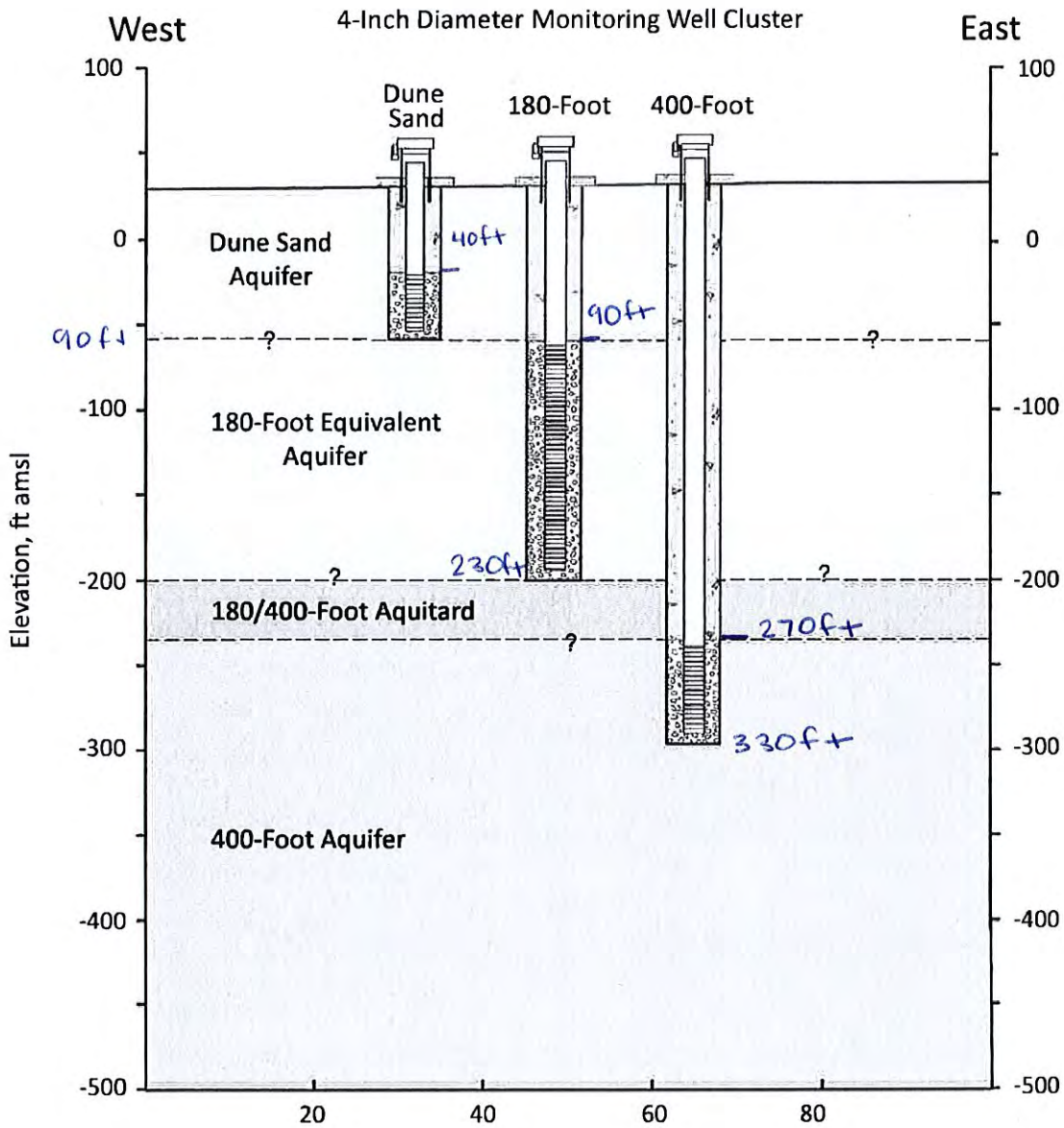
EXPIRATION DATE: 11/21/2015

ISSUED BY:



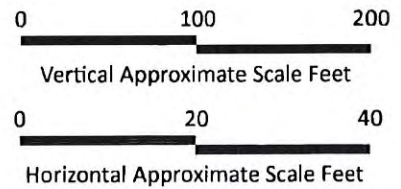
Marni Flagg, REHS
Senior Environmental Health Specialist

(Rev. 1/04,10/13)



Geologic Units

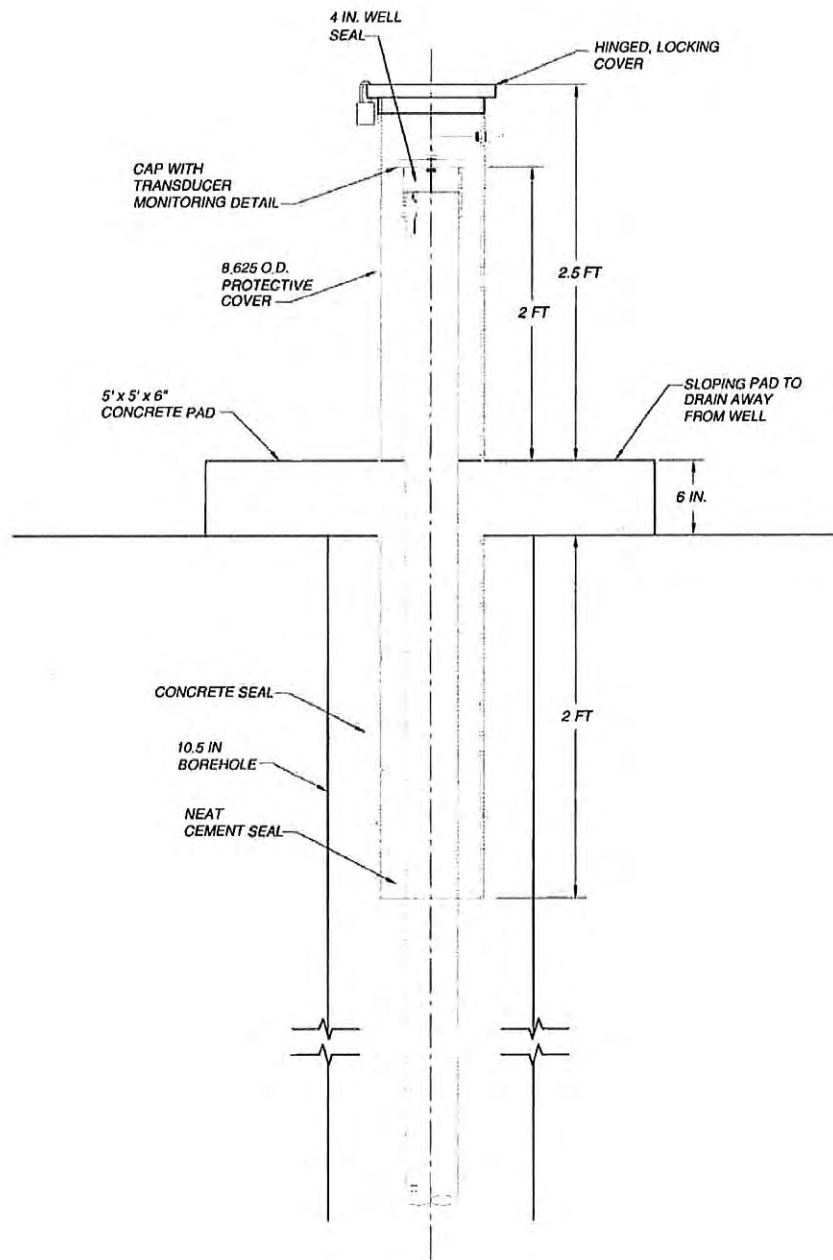
- Dune Sand Aquifer
- 180/400-Foot Aquitard
- 180-Foot Equivalent Aquifer
- 400-Foot Aquifer
- Geologic Contact (approximate)



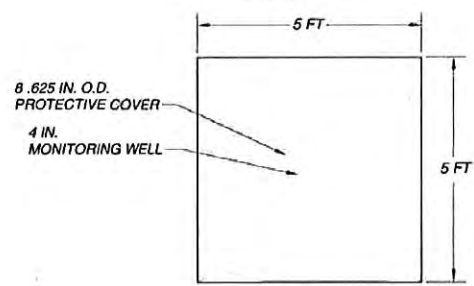
Source of Lithology: GEOSCIENCE (2014)
Well dimensions not to scale.

DRAFT


<p><small>GEOSCIENCE</small></p> <p><small>14011 Rockledge Blvd, Suite 200, Jacksonville, FL 32226</small></p> <p><small>904 444-1111</small></p> <p><small>www.geoscience.com</small></p>	<p>CALIFORNIA AMERICAN WATER/RBF CONSULTING</p> <p>CONCEPTUAL MONITORING WELL DESIGN</p> <p>CEMEX AREA</p>	<p>Figure</p> <p>3</p>
<p>Date: 27-Jun-14</p>		



PROFILE
NOT TO SCALE



PLAN
NOT TO SCALE

 <small>'SETTING THE STANDARD IN WATER WELL DESIGN SINCE 1978' 909.451.6650 gsewater.com</small>	MONTEREY PENINSULA WATER SUPPLY PROJECT	Date: 27-JUN-14	FIGURE
	HYDROGEOLOGIC INVESTIGATION REPORT -ATTACHMENT 1	Designed: MDW	4
	MONITORING WELL WELLHEAD DETAIL - MONUMENT COVER AND WELL PAD	Checked: DEW	
		File: NSL-CLM-04-09	



MONITORING WELL PERMIT

PERMIT NO: 14-12454

-MONITORING WELL

-CONSTRUCTION

-PIEZOMETER

-DESTRUCTION

SITE LOCATION: Cemex Plant end of Lapis Rd (MW-2S, MW-2M, MW-2D)

APN #: 203-011-019-000

<p>SITE CONTACT PERSON: MARIO ROMERO</p> <p>PHONE: (909)946-1640</p>	<p>OWNER: CAL AM – IAN CROOKS 511 FOREST LODGE RD, STE 100 PACIFIC GROVE, CA 93950 PHONE: (831)646-3217</p>
<p>CONSULTANT:</p> <p>PHONE:</p>	<p>DRILLER: CASCADE DRILLING 1333 WEST 9TH STREET UPLAND, CA 91786 LICENSE #: C-57 938110 PHONE : (909)946-1640</p>

CONDITIONS:

1. All requirements set forth in Monterey Code Chapter 15.08 and Bulletins 74-81 and 74-90, shall be complied with at all times.
2. The well shall be at least 100 feet from any septic tank; any portion of any leach field or animal enclosure; 50 feet from any sewer main, line or lateral; and 150 feet from any seepage pit. If type of absorption field is unknown, the distance shall be 150 feet.
3. Location of the well shall not prevent the installation, relocation or expansion of the septic system on any adjoining lot.
4. Permit shall be kept on site at all times while work is in progress.
5. The well shall be drilled in the approved location delineated on the attached map, Exhibit A. The well cannot be drilled in any other location without prior approval from Monterey County Health Department, Environmental Health Bureau (EHB) and receipt of an amended permit.
6. The well shall be constructed per attached design, Exhibit B.
7. Any well on the premises which is to be abandoned, or which has been abandoned shall be properly destroyed within six months of the completion of this well.

8. Notify the EHB at least 24 hours prior to moving on site.
9. Notify the EHB 24 hours prior to the time you expect to place any seal.
10. The sealing material shall be neat cement.
11. If the seal(s) cannot be witnessed by the EHB, a detailed, written description of the seal(s) shall be submitted to the EHB within ten days.
12. Surface construction features of the completed well shall be in accordance with the California Well Standards Bulletin 74-81 and Bulletin 74-90 Section 10.
13. The permit applicants shall indemnify and hold harmless the County and its officers, agents, and employees from actions or claims of any description brought on account of any injury or damages sustained, by any person or property resulting from the issuance of the permit and the conduct of the activities authorized under said permit.
14. Issuance of this permit to construct a well does not create, transfer, assign or acknowledge any legal rights to water associated with this property.
15. Submit a Well Completion Report within 60 days upon completion.

DATE ISSUED: 11/21/2014

EXPIRATION DATE: 11/21/2015

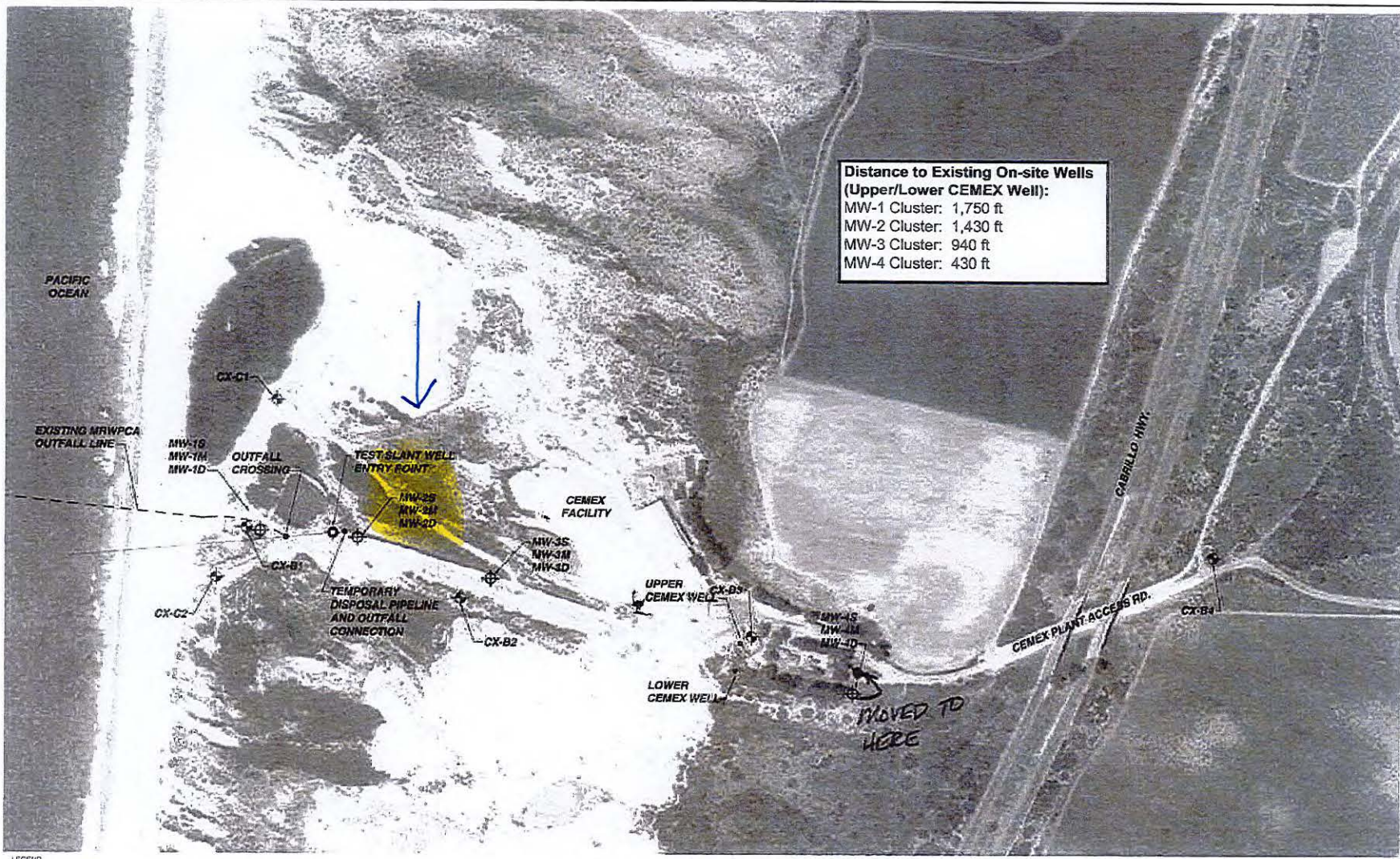
ISSUED BY:



Marni Flagg, REHS
Senior Environmental Health Specialist

(Rev. 1/04,10/13)

Exhibit A

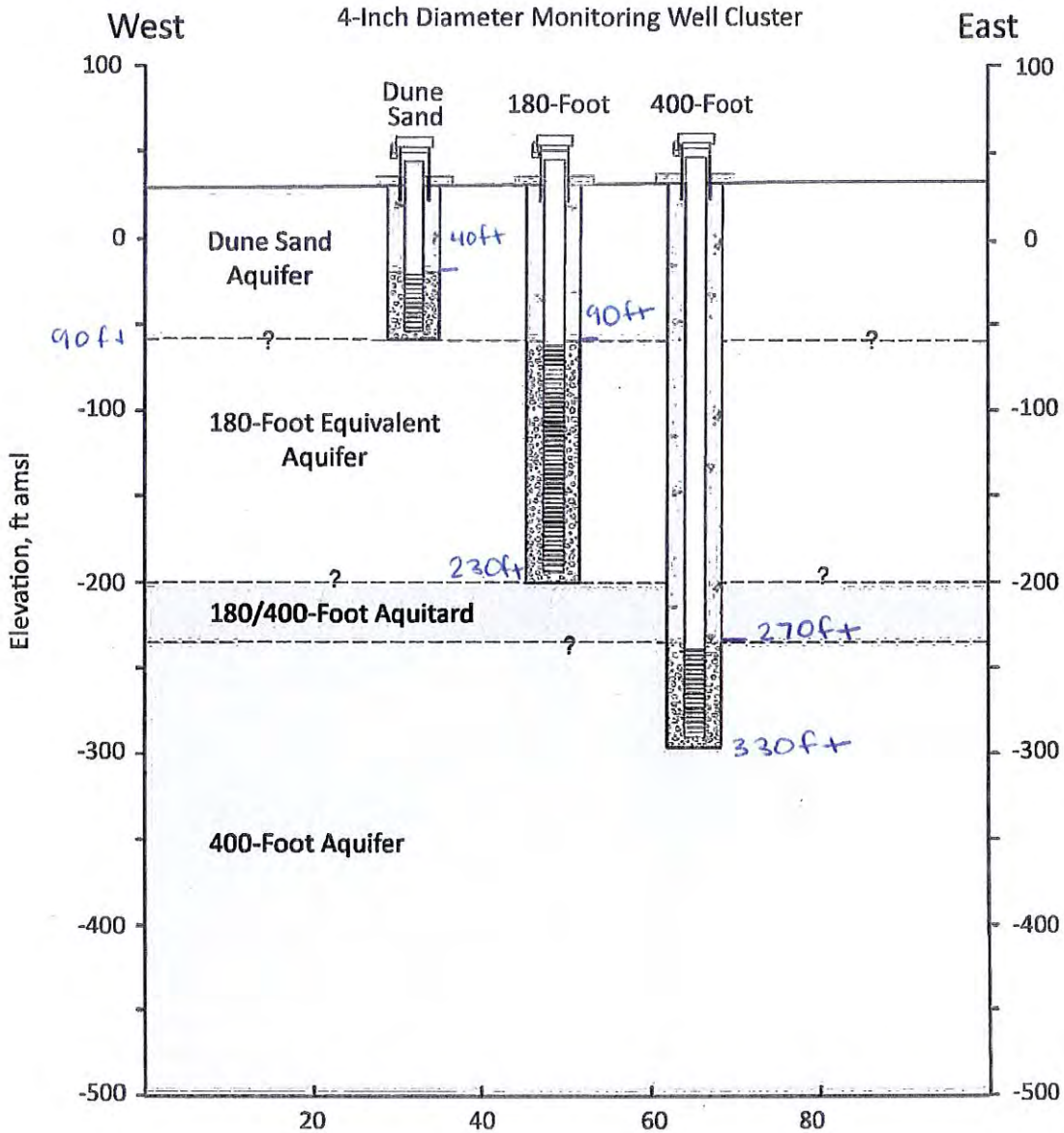


**Distance to Existing On-site Wells
(Upper/Lower CEMEX Well):**
 MW-1 Cluster: 1,750 ft
 MW-2 Cluster: 1,430 ft
 MW-3 Cluster: 940 ft
 MW-4 Cluster: 430 ft

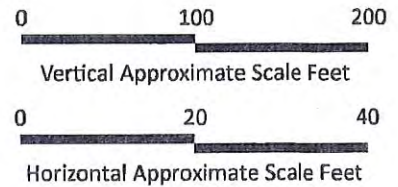
- LEGEND**
- ⊕ PROPOSED EXPLORATORY BORING LOCATIONS
 - ⊕ PROPOSED TEST SLANT WELL
 - ⊕ EXISTING CEMEX WELL
 - ⊕ PROPOSED MONITORING WELLS



	PROJECT NUMBER: 140 DATE:			PROPOSED CEMEX AREA MONITORING WELL LOCATIONS	Rev. Desc. By	Date: 08-AUG-14	FIGURE 2	
	DRAWING NUMBER:			TECHNICAL SPECIFICATIONS - MONITORING WELLS	1			Designed AS
	DRAWING TITLE:			PREPARED FOR: CALIFORNIA AMERICAN WATER / RBF CONSULTING	2			Checked: MW
	DATE:				4			File: 140-001-001.dwg



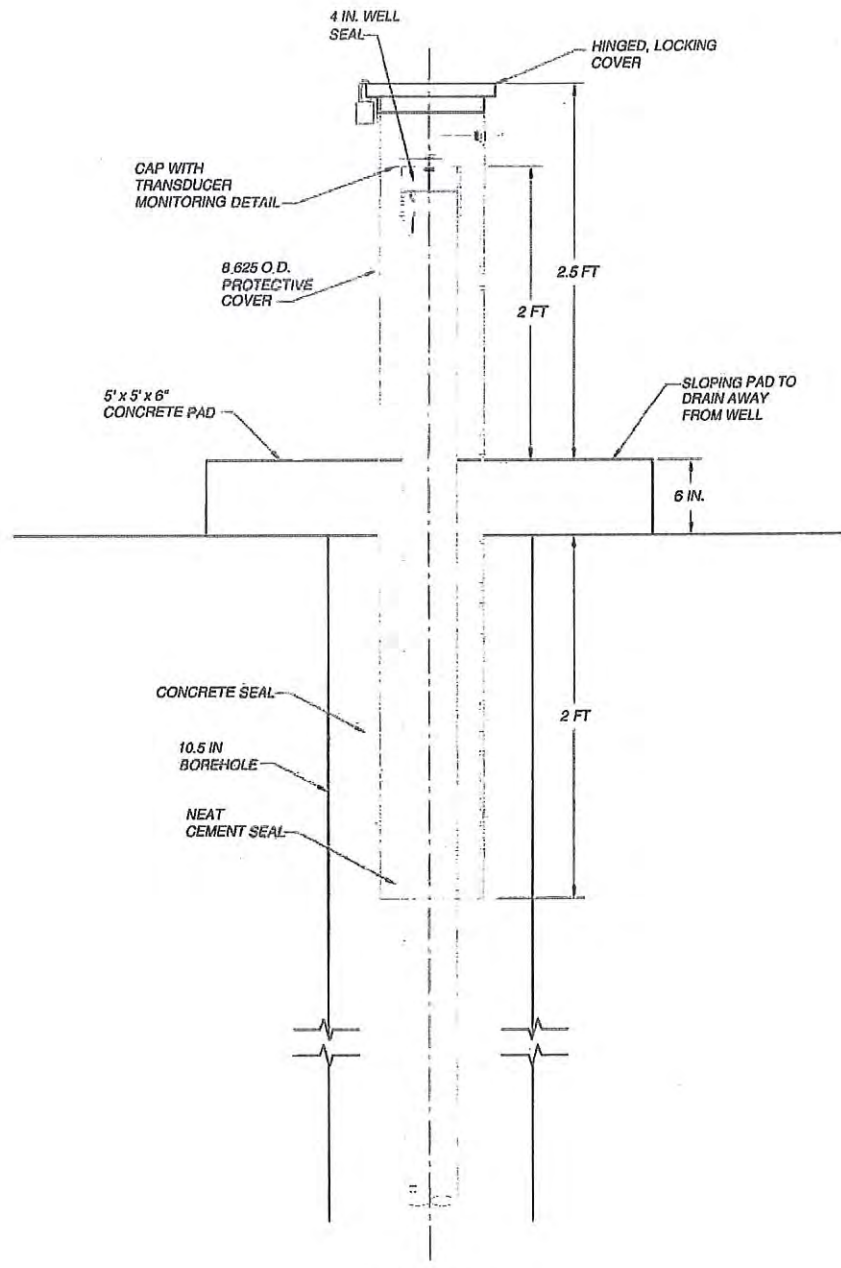
- Geologic Units**
- Dune Sand Aquifer
 - 180/400-Foot Aquitard
 - 180-Foot Equivalent Aquifer
 - 400-Foot Aquifer
- Geologic Contact (approximate)



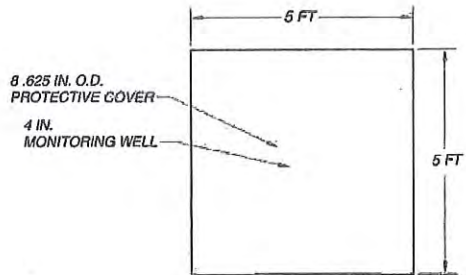
Source of Lithology: GEOSCIENCE (2014)
Well dimensions not to scale.

DRAFT

<p>GEOSCIENCE <small>CENTRAL CALIFORNIA REGIONAL OFFICE 70 Box 220, Clearlake, CA 94527 Tel: (707) 438-1234 • Fax: (707) 438-1235 E-mail: central@geoscience.com</small></p>	<p>CALIFORNIA AMERICAN WATER/RBF CONSULTING</p> <p>CONCEPTUAL MONITORING WELL DESIGN</p> <p>CEMEX AREA</p>	<p>Figure</p> <p>3</p>
<p>Date: 27-Jun-14</p>		



PROFILE
NOT TO SCALE



PLAN
NOT TO SCALE



MONITORING WELL PERMIT

PERMIT NO: 14-12455

-MONITORING WELL

-CONSTRUCTION

-PIEZOMETER

-DESTRUCTION

SITE LOCATION: Cemex Plant end of Lapis Rd (MW-3S, MW-3M, MW-3D)

APN #: 203-011-019-000

<p>SITE CONTACT PERSON: MARIO ROMERO</p> <p>PHONE: (909)946-1640</p>	<p>OWNER: CAL AM – IAN CROOKS 511 FOREST LODGE RD, STE 100 PACIFIC GROVE, CA 93950 PHONE: (831)646-3217</p>
<p>CONSULTANT:</p> <p>PHONE:</p>	<p>DRILLER: CASCADE DRILLING 1333 WEST 9TH STREET UPLAND, CA 91786 LICENSE #: C-57 938110 PHONE : (909)946-1640</p>

CONDITIONS:

1. All requirements set forth in Monterey Code Chapter 15.08 and Bulletins 74-81 and 74-90, shall be complied with at all times.
2. The well shall be at least 100 feet from any septic tank; any portion of any leach field or animal enclosure; 50 feet from any sewer main, line or lateral; and 150 feet from any seepage pit. If type of absorption field is unknown, the distance shall be 150 feet.
3. Location of the well shall not prevent the installation, relocation or expansion of the septic system on any adjoining lot.
4. Permit shall be kept on site at all times while work is in progress.
5. The well shall be drilled in the approved location delineated on the attached map, Exhibit A. The well cannot be drilled in any other location without prior approval from Monterey County Health Department, Environmental Health Bureau (EHB) and receipt of an amended permit.
6. The well shall be constructed per attached design, Exhibit B.
7. Any well on the premises which is to be abandoned, or which has been abandoned shall be properly destroyed within six months of the completion of this well.

8. Notify the EHB at least 24 hours prior to moving on site.
9. Notify the EHB 24 hours prior to the time you expect to place any seal.
10. The sealing material shall be neat cement.
11. If the seal(s) cannot be witnessed by the EHB, a detailed, written description of the seal(s) shall be submitted to the EHB within ten days.
12. Surface construction features of the completed well shall be in accordance with the California Well Standards Bulletin 74-81 and Bulletin 74-90 Section 10.
13. The permit applicants shall indemnify and hold harmless the County and its officers, agents, and employees from actions or claims of any description brought on account of any injury or damages sustained, by any person or property resulting from the issuance of the permit and the conduct of the activities authorized under said permit.
14. Issuance of this permit to construct a well does not create, transfer, assign or acknowledge any legal rights to water associated with this property.
15. Submit a Well Completion Report within 60 days upon completion.

DATE ISSUED: 11/21/2014

EXPIRATION DATE: 11/21/2015

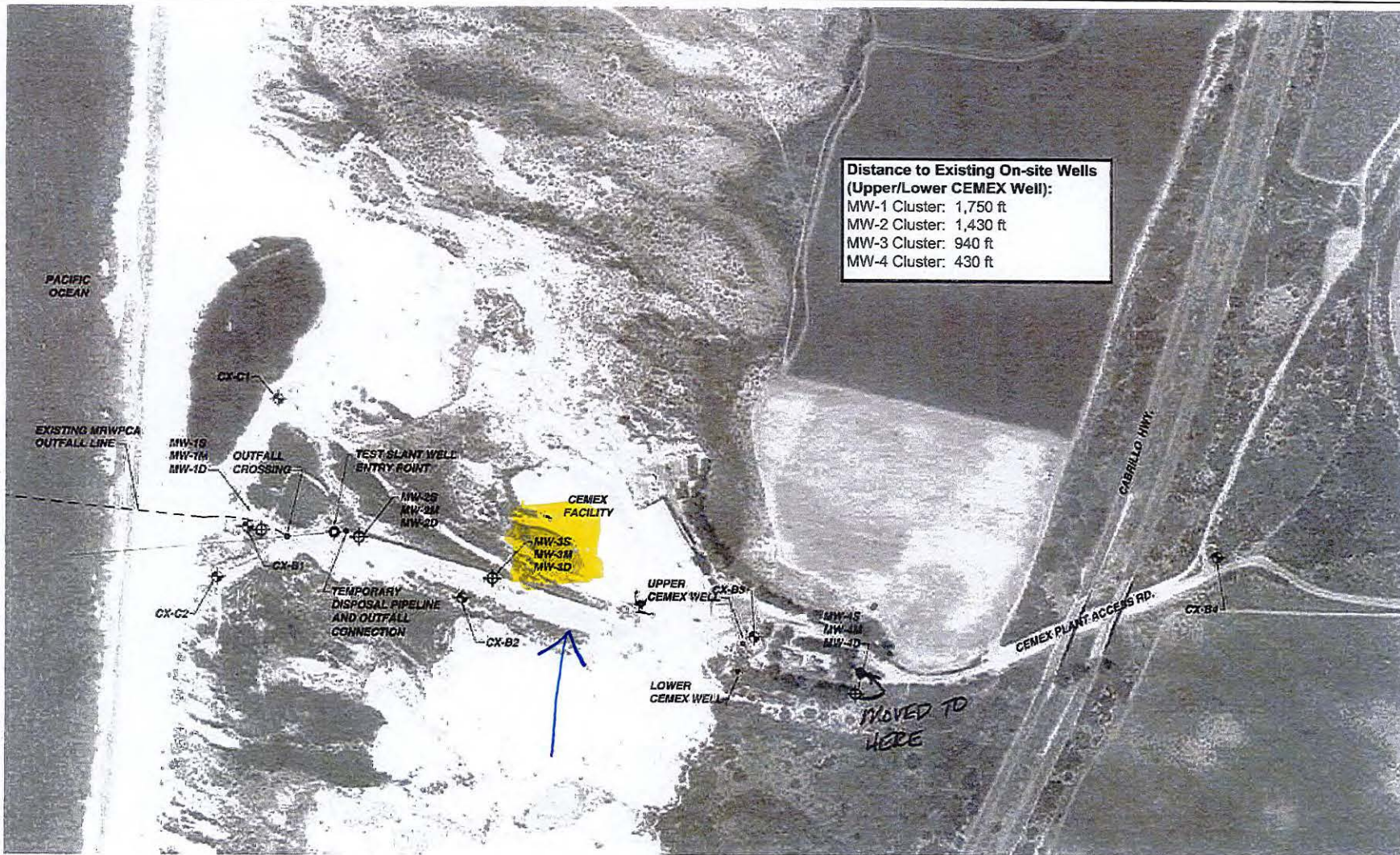
ISSUED BY:



Marni Flagg, REHS
Senior Environmental Health Specialist

(Rev. 1/04,10/13)

Exhibit A

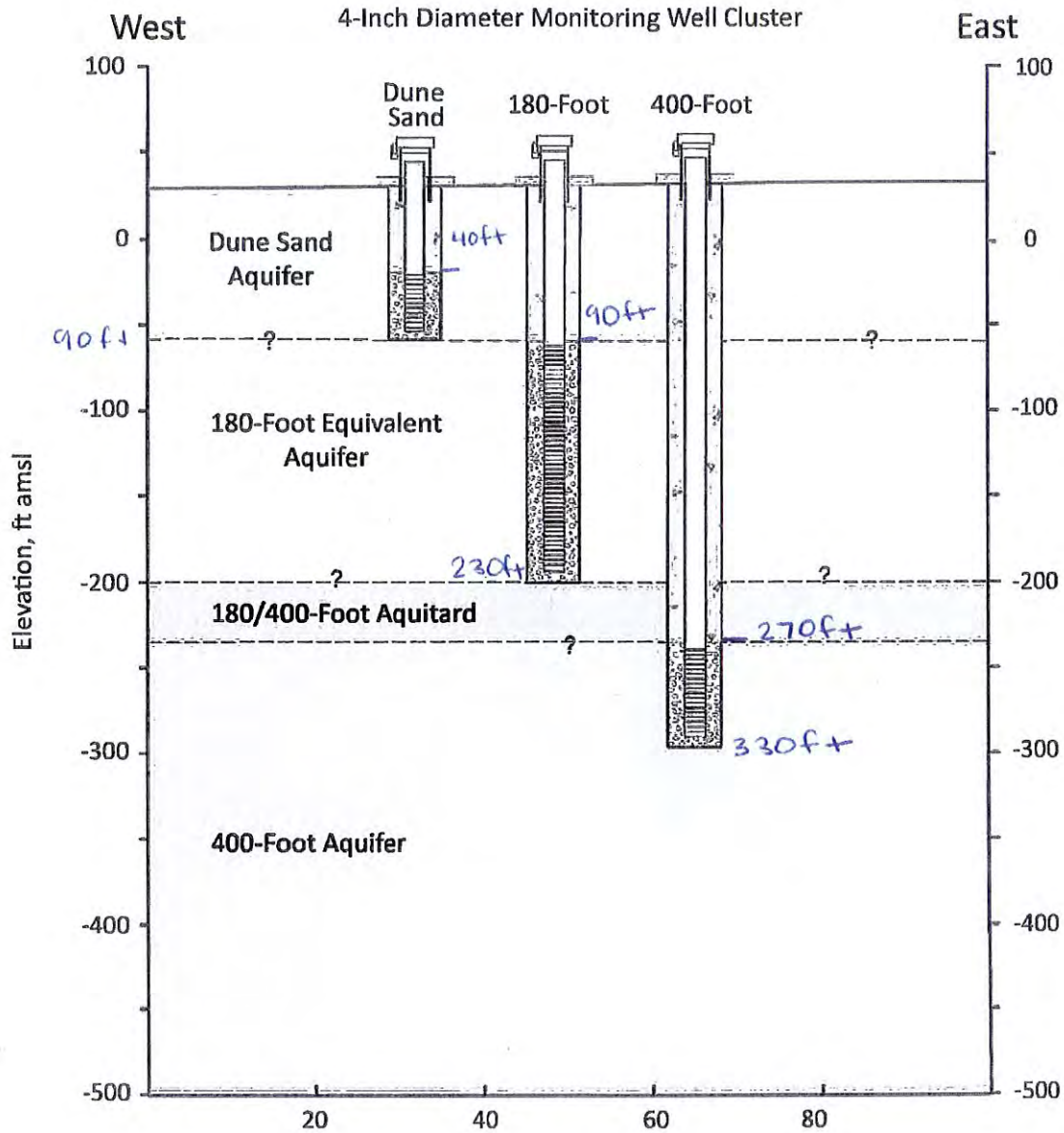


Distance to Existing On-site Wells (Upper/Lower CEMEX Well):
 MW-1 Cluster: 1,750 ft
 MW-2 Cluster: 1,430 ft
 MW-3 Cluster: 940 ft
 MW-4 Cluster: 430 ft

- LEGEND**
- ⊕ PROPOSED EXPLORATORY BORING LOCATIONS
 - ⊕ PROPOSED TEST SLANT WELL
 - ⊕ EXISTING CEMEX WELL
 - ⊕ PROPOSED MONITORING WELLS

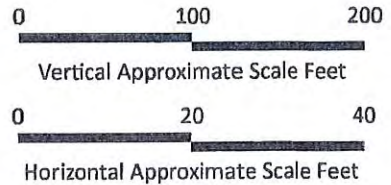


	PROPOSED CEMEX AREA MONITORING WELL LOCATIONS			Date 08-AUG-14	FIGURE 2
	TECHNICAL SPECIFICATIONS - MONITORING WELLS			Designed AS	
	PREPARED FOR CALIFORNIA AMERICAN WATER / RBF CONSULTING			Checked MW	
	PROJECT ENGINEER: [Name]	DATE: [Date]	CHECKED BY: [Name]	FILE: [File Path]	



Geologic Units

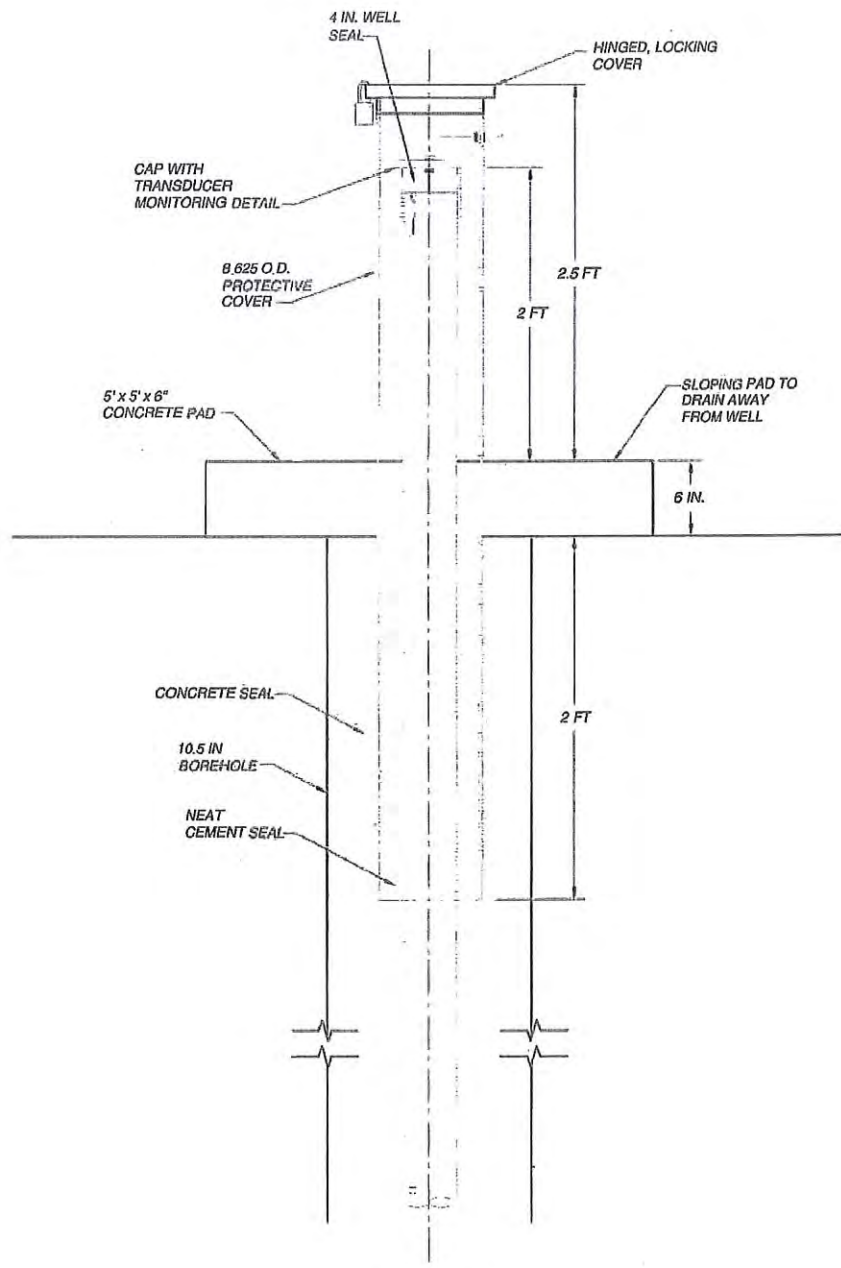
- Dune Sand Aquifer
- 180/400-Foot Aquitard
- 180-Foot Equivalent Aquifer
- 400-Foot Aquifer
- Geologic Contact (approximate)



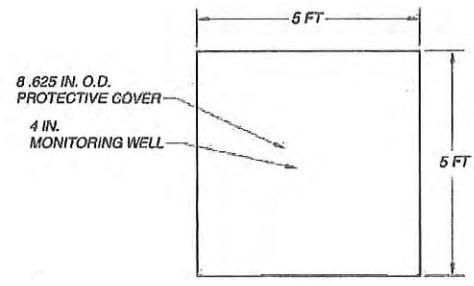
Source of Lithology: GEOSCIENCE (2014)
Well dimensions not to scale.

DRAFT


<p>GEOSCIENCE <small>California American Water/RBF Consulting 10000 California Blvd., Suite 1000, San Diego, CA 92123 Tel: 619.594.1111 Fax: 619.594.1112 Email: gsc@caawater.com</small></p>	<p>CALIFORNIA AMERICAN WATER/RBF CONSULTING</p> <p>CONCEPTUAL MONITORING WELL DESIGN</p> <p>CEMEX AREA</p>	<p>Figure</p> <p>3</p>
<p>Date: 27-Jun-14</p>		



PROFILE
NOT TO SCALE



PLAN
NOT TO SCALE

 "SETTING THE STANDARD IN WATER WELL DESIGN SINCE 1970" 809.451.6650 gsswater.com	MONTEREY PENINSULA WATER SUPPLY PROJECT	Date: 27-JUN-14	FIGURE
	HYDROGEOLOGIC INVESTIGATION REPORT - ATTACHMENT 1	Designed: MDW	4
	MONITORING WELL WELLHEAD DETAIL - MONUMENT COVER AND WELL PAD	Checked: DEW	
	File: MSL-CLM-01-4.dwg		



MONITORING WELL PERMIT

PERMIT NO: 14-12456

-MONITORING WELL

-CONSTRUCTION

-PIEZOMETER

-DESTRUCTION

SITE LOCATION: Cemex Plant end of Lapis Rd (MW-4S, MW-4M, MW-4D)

APN #: 203-011-019-000

<p>SITE CONTACT PERSON: MARIO ROMERO</p> <p>PHONE: (909)946-1640</p>	<p>OWNER: CAL AM – IAN CROOKS 511 FOREST LODGE RD, STE 100 PACIFIC GROVE, CA 93950</p> <p>PHONE: (831)646-3217</p>
<p>CONSULTANT:</p> <p>PHONE:</p>	<p>DRILLER: CASCADE DRILLING 1333 WEST 9TH STREET UPLAND, CA 91786</p> <p>LICENSE #: C-57 938110 PHONE : (909)946-1640</p>

CONDITIONS:

1. All requirements set forth in Monterey Code Chapter 15.08 and Bulletins 74-81 and 74-90, shall be complied with at all times.
2. The well shall be at least 100 feet from any septic tank; any portion of any leach field or animal enclosure; 50 feet from any sewer main, line or lateral; and 150 feet from any seepage pit. If type of absorption field is unknown, the distance shall be 150 feet.
3. Location of the well shall not prevent the installation, relocation or expansion of the septic system on any adjoining lot.
4. Permit shall be kept on site at all times while work is in progress.
5. The well shall be drilled in the approved location delineated on the attached map, Exhibit A. The well cannot be drilled in any other location without prior approval from Monterey County Health Department, Environmental Health Bureau (EHB) and receipt of an amended permit.
6. The well shall be constructed per attached design, Exhibit B.
7. Any well on the premises which is to be abandoned, or which has been abandoned shall be properly destroyed within six months of the completion of this well.

8. Notify the EHB at least 24 hours prior to moving on site.
9. Notify the EHB 24 hours prior to the time you expect to place any seal.
10. The sealing material shall be neat cement.
11. If the seal(s) cannot be witnessed by the EHB, a detailed, written description of the seal(s) shall be submitted to the EHB within ten days.
12. Surface construction features of the completed well shall be in accordance with the California Well Standards Bulletin 74-81 and Bulletin 74-90 Section 10.
13. The permit applicants shall indemnify and hold harmless the County and its officers, agents, and employees from actions or claims of any description brought on account of any injury or damages sustained, by any person or property resulting from the issuance of the permit and the conduct of the activities authorized under said permit.
14. Issuance of this permit to construct a well does not create, transfer, assign or acknowledge any legal rights to water associated with this property.
15. Submit a Well Completion Report within 60 days upon completion.

DATE ISSUED: 11/25/2014

EXPIRATION DATE: 11/25/2015

ISSUED BY:

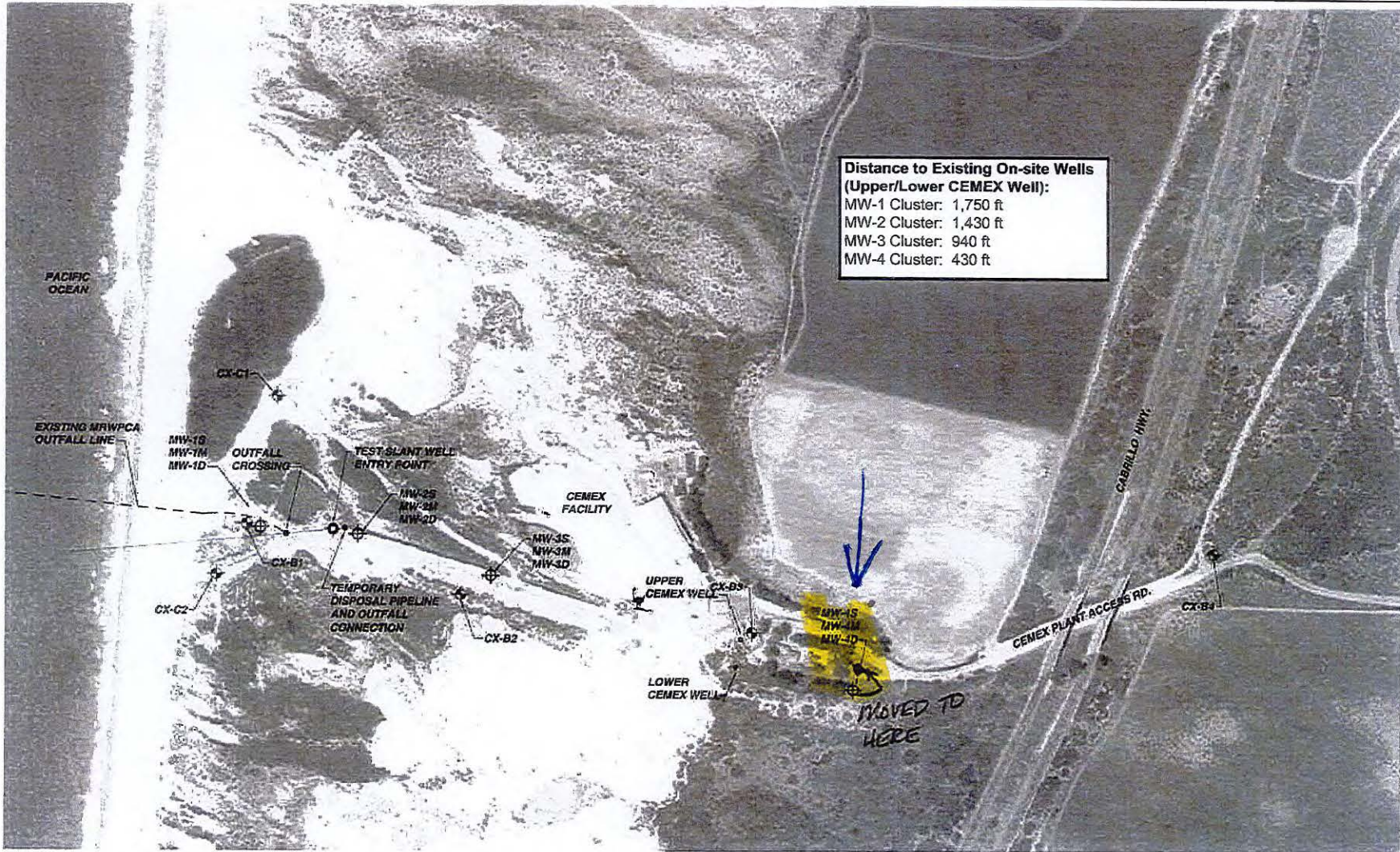


Marni Flagg, REHS
Senior Environmental Health Specialist

(Rev. 1/04,10/13)

Exhibit A

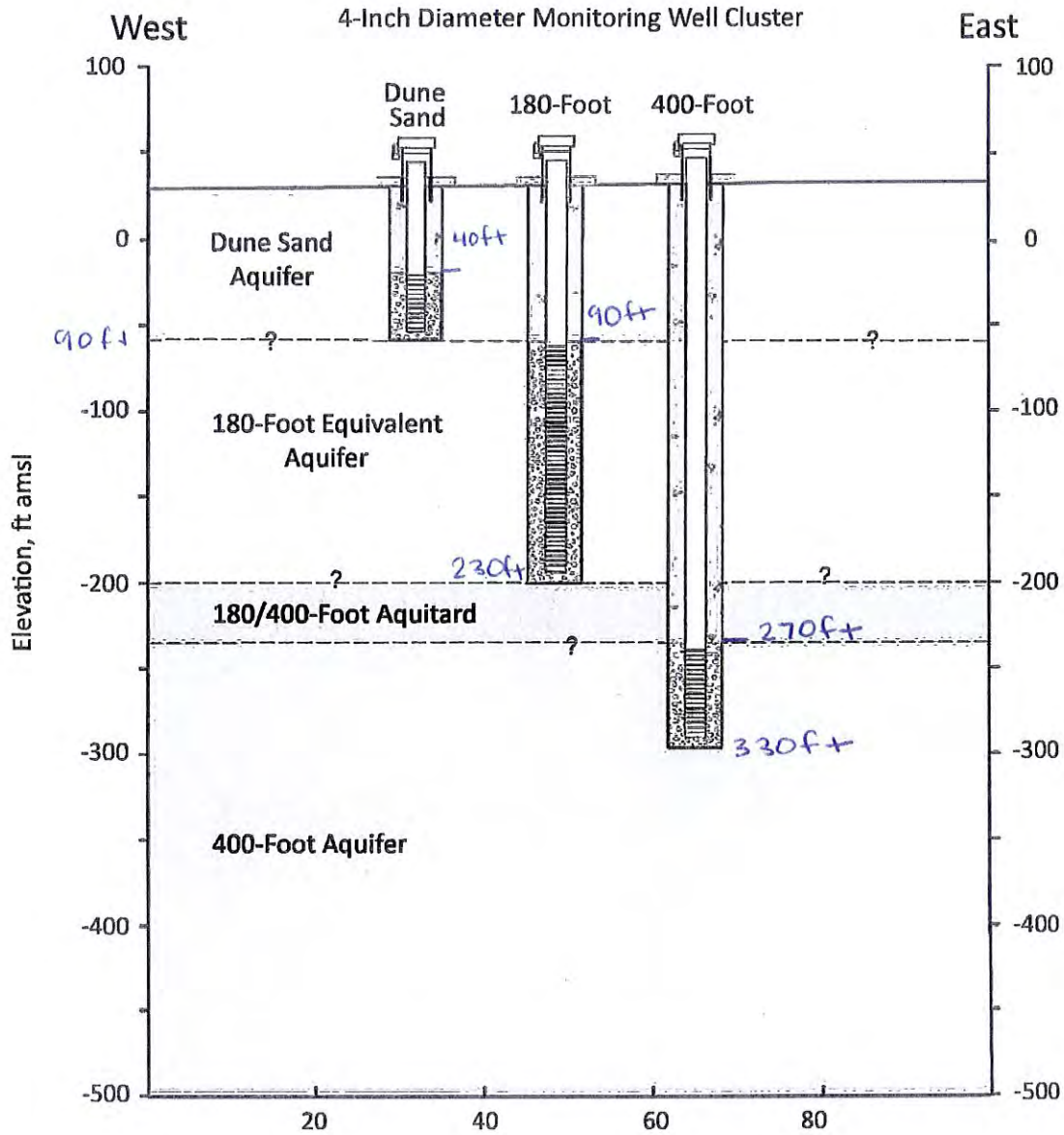
**Distance to Existing On-site Wells
(Upper/Lower CEMEX Well):**
 MW-1 Cluster: 1,750 ft
 MW-2 Cluster: 1,430 ft
 MW-3 Cluster: 940 ft
 MW-4 Cluster: 430 ft



- LEGEND**
- ⊕ PROPOSED EXPLORATORY BORING LOCATIONS
 - ⊙ EXISTING CEMEX WELL
 - ⊕ PROPOSED TEST SLANT WELL
 - ⊕ PROPOSED MONITORING WELLS

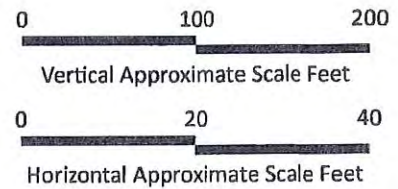


	PROJECT ENGINEER: [Name] NO DATE			PROPOSED CEMEX AREA MONITORING WELL LOCATIONS			Rev.	Qty	Sr	Description	Date	FIGURE 2
	PROJECT ENGINEER: [Name] NO DATE			TECHNICAL SPECIFICATIONS - MONITORING WELLS			1				08-AUG-14	
	PROJECT ENGINEER: [Name] NO DATE			PREPARED FOR CALIFORNIA AMERICAN WATER / RBF CONSULTING			2				Designed AS	
	PROJECT ENGINEER: [Name] NO DATE			PREPARED FOR CALIFORNIA AMERICAN WATER / RBF CONSULTING			3				Checked MW	
PROJECT ENGINEER: [Name] NO DATE			PREPARED FOR CALIFORNIA AMERICAN WATER / RBF CONSULTING			4				File: 108-0148-0002		



Geologic Units

- Dune Sand Aquifer
- 180/400-Foot Aquitard
- 180-Foot Equivalent Aquifer
- 400-Foot Aquifer
- Geologic Contact (approximate)



Source of Lithology: GEOSCIENCE (2014)
Well dimensions not to scale.

DRAFT

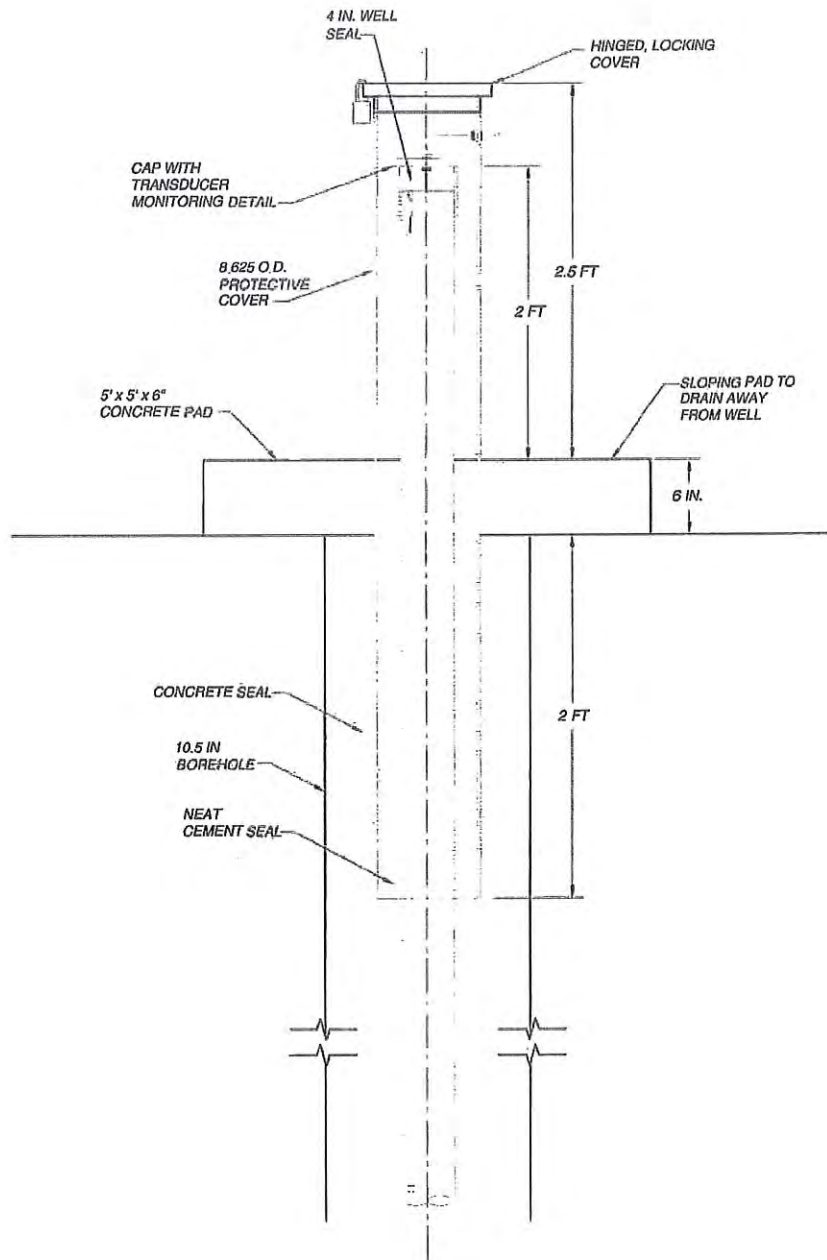
GEOSCIENCE
CONSULTING ENGINEERS & GEOLOGISTS, INC.
 10000 Wilshire Blvd., Suite 200
 Los Angeles, CA 90024
 Tel: 310.206.1111
 Fax: 310.206.1112
 www.geoscience.com

Date: 27-Jun-14

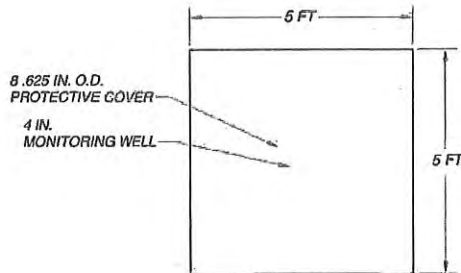
CALIFORNIA AMERICAN WATER/RBF CONSULTING

**CONCEPTUAL MONITORING WELL DESIGN
CEMEX AREA**

**Figure
3**



PROFILE
NOT TO SCALE



PLAN
NOT TO SCALE

GEOSCIENCE

“SETTING THE STANDARD IN WATER WELL DESIGN SINCE 1970”
809.451.6650 | gsswater.com

MONTEREY PENINSULA WATER SUPPLY PROJECT

HYDROGEOLOGIC INVESTIGATION REPORT - ATTACHMENT 1

MONITORING WELL WELLHEAD DETAIL - MONUMENT COVER AND WELL PAD

Date: 27-JUN-14

Designed: MDW

Checked: DEW

File: NSL-CLM-01-4-010

FIGURE

4



MONITORING WELL PERMIT

PERMIT NO: 14-12460

-MONITORING WELL

-CONSTRUCTION

-PIEZOMETER

-DESTRUCTION

SITE LOCATION: Charles Benson Rd (MW-1S, MW-1M, MW-1D)

APN #: 229-011-021-000

<p><i>SITE CONTACT PERSON:</i> MARIO ROMERO</p> <p><i>PHONE:</i> (909)946-1640</p>	<p><i>OWNER:</i> CAL AM – IAN CROOKS 511 FOREST LODGE RD, STE 100 PACIFIC GROVE, CA 93950</p> <p><i>PHONE:</i> (831)646-3217</p>
<p><i>CONSULTANT:</i></p> <p><i>PHONE:</i></p>	<p><i>DRILLER:</i> CASCADE DRILLING 1333 WEST 9TH STREET UPLAND, CA 91786</p> <p><i>LICENSE #:</i> C-57 938110</p> <p><i>PHONE :</i> (909)946-1640</p>

CONDITIONS:

1. All requirements set forth in Monterey Code Chapter 15.08 and Bulletins 74-81 and 74-90, shall be complied with at all times.
2. The well shall be at least 100 feet from any septic tank; any portion of any leach field or animal enclosure; 50 feet from any sewer main, line or lateral; and 150 feet from any seepage pit. If type of absorption field is unknown, the distance shall be 150 feet.
3. Location of the well shall not prevent the installation, relocation or expansion of the septic system on any adjoining lot.
4. Permit shall be kept on site at all times while work is in progress.
5. The well shall be drilled in the approved location delineated on the attached map, Exhibit A. The well cannot be drilled in any other location without prior approval from Monterey County Health Department, Environmental Health Bureau (EHB) and receipt of an amended permit.
6. The well shall be constructed per attached design, Exhibit B.
7. Any well on the premises which is to be abandoned, or which has been abandoned shall be properly destroyed within six months of the completion of this well.

8. Notify the EHB at least 24 hours prior to moving on site.
9. Notify the EHB 24 hours prior to the time you expect to place any seal.
10. The sealing material shall be neat cement.
11. If the seal(s) cannot be witnessed by the EHB, a detailed, written description of the seal(s) shall be submitted to the EHB within ten days.
12. Surface construction features of the completed well shall be in accordance with the California Well Standards Bulletin 74-81 and Bulletin 74-90 Section 10.
13. The permit applicants shall indemnify and hold harmless the County and its officers, agents, and employees from actions or claims of any description brought on account of any injury or damages sustained, by any person or property resulting from the issuance of the permit and the conduct of the activities authorized under said permit.
14. *If, during the course of construction, cultural, archaeological, historical or paleontological resources are uncovered at the site (surface or subsurface resources) work shall be halted immediately within 50 meters (165 feet) of the find until a qualified professional archaeologist can evaluate it. Monterey County RMA - Planning and a qualified archaeologist (i.e., an archaeologist registered with the Register of Professional Archaeologists) shall be immediately contacted by the responsible individual present on-site. When contacted, the project planner and the archaeologist shall immediately visit the site to determine the extent of the resources and to develop proper mitigation measures required for the discovery. See **Exhibit C**.
15. * Proposed well site has been issued the attached archeological waiver, **Exhibit C**. The construction must meet the limitations in the attached archeological waiver.
16. Issuance of this permit to construct a well does not create, transfer, assign or acknowledge any legal rights to water associated with this property.
17. Submit a Well Completion Report within 60 days upon completion.

***Exhibit C**: Questions regarding these conditions can be directed to RMA-Planning Department, 755-6414

DATE ISSUED: 12/11/2014

EXPIRATION DATE: 12/11/2015

ISSUED BY:



Marni Flagg, REHS
Senior Environmental Health Specialist

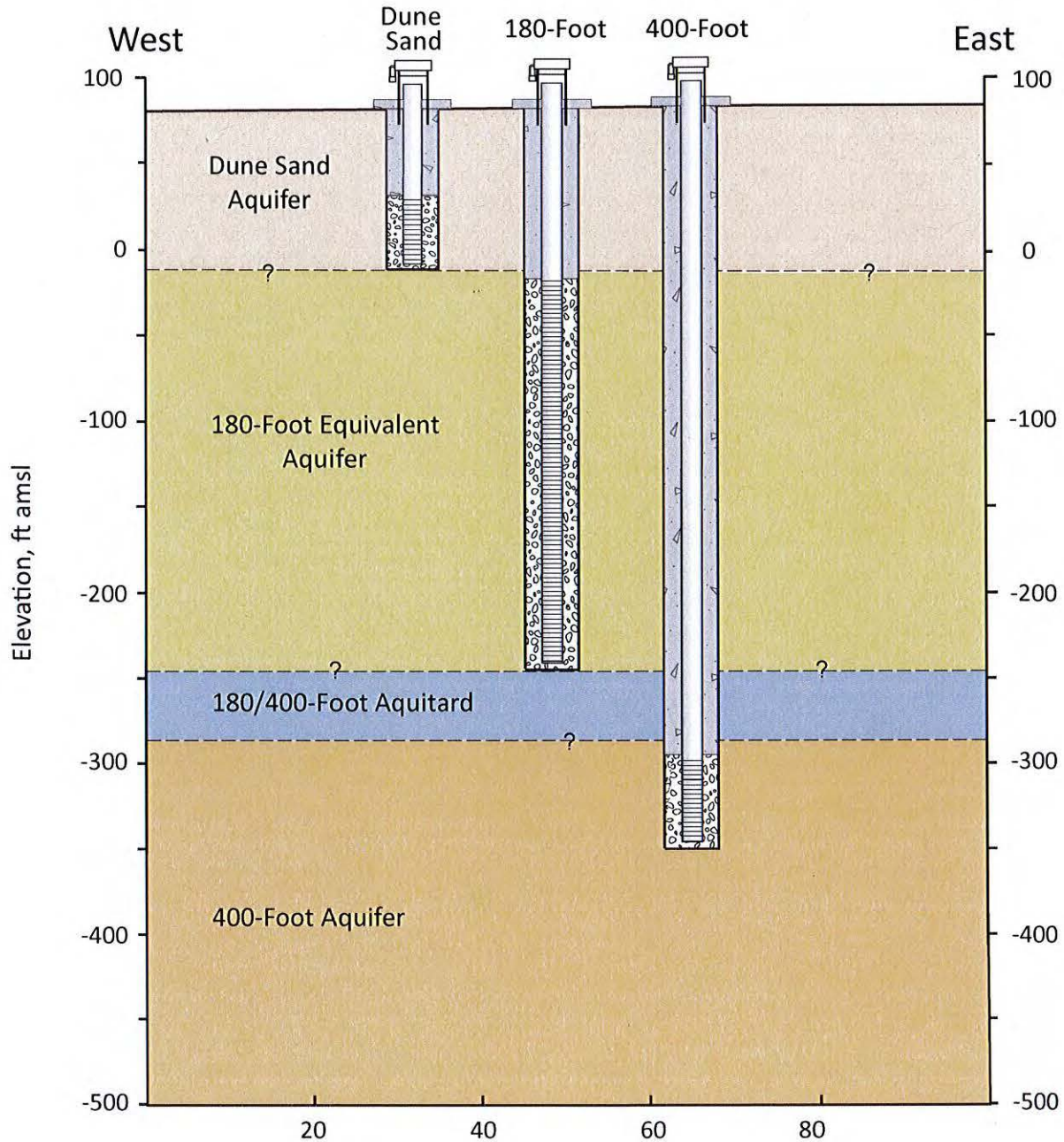
(Rev. 1/04,10/13)

Exhibit A



Exhibit B1

4-Inch Diameter Monitoring Well Cluster



Geologic Units

- Dune Sand Aquifer
- 180/400-Foot Aquitard
- 180-Foot Equivalent Aquifer
- 400-Foot Aquifer

--- Geologic Contact (approximate)

0 100 200

Vertical Approximate Scale Feet

0 20 40

Horizontal Approximate Scale Feet

Source of Lithology: GEOSCIENCE (2014)
Well dimensions not to scale.

DRAFT

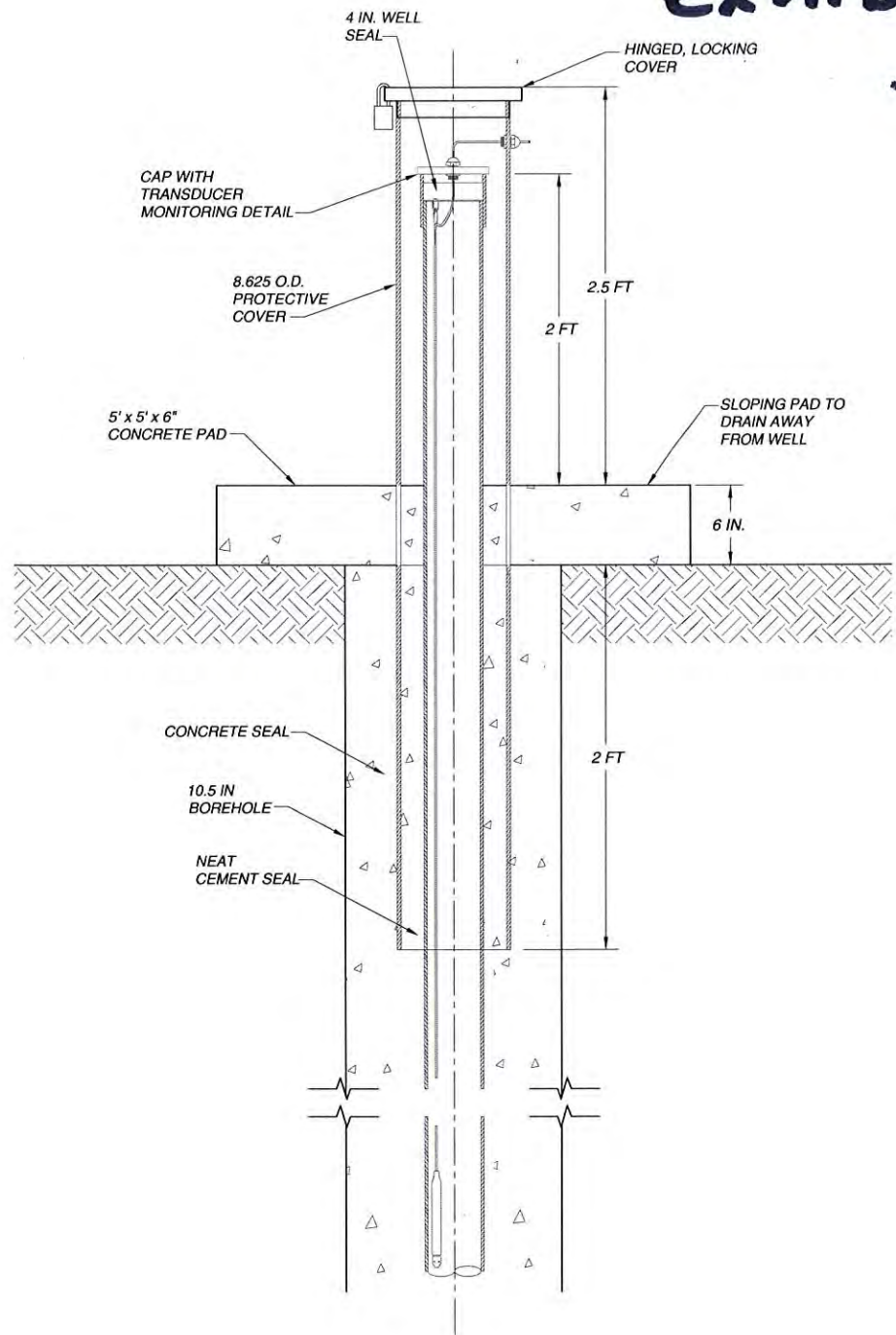
GEOSCIENCE
GEOSCIENCE Support Services, Inc.
P.O. Box 220, Claremont, CA 91711
Tel: (909) 920-0717 Fax: (909) 920-0403
E-mail: email@geoscience-water.com

CALIFORNIA AMERICAN WATER/RBF CONSULTING

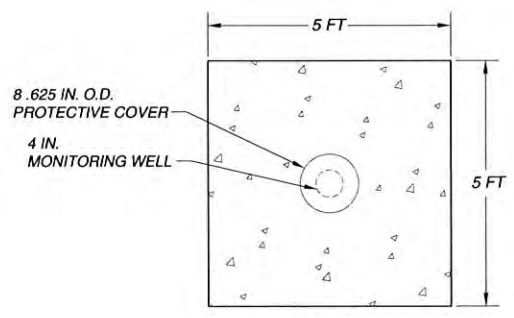
**PRELIMINARY MONITORING WELL DESIGN
MONTEREY PENINSULA LANDFILL AREA**

**Figure
2**

Date: 13-Nov-14



PROFILE
NOT TO SCALE



PLAN
NOT TO SCALE

DRAFT



"SETTING THE STANDARD IN WATER WELL DESIGN SINCE 1978"
909.451.6650 | gsswater.com

MONTEREY PENINSULA WATER SUPPLY PROJECT
PRELIMINARY MONITORING WELL DESIGN
MONITORING WELL WELLHEAD DETAIL - MONUMENT COVER AND WELL PAD

Date:
Designed: MDW
Checked: DEW
File: MSL-CLAM 04-4.dwg

FIGURE

3

Exhibit C

RESOURCE MANAGEMENT AGENCY - PLANNING <u>CONDITION COMPLIANCE & MITIGATION MONITORING AND</u> <u>REPORTING PLAN</u>	PROJECT NAME: CAL-AM <u>File No: #14-12460</u> <u>APNs: 229-011-021-000</u> <u>Approval by: Grace Bogdan</u> <u>Date: December 9, 2014</u>
--	---

**Monitoring or Reporting refers to projects with an EIR or adopted Mitigated Negative Declaration per Section 21081.6 of the Public Resources Code.*

<i>Permit Cond. Number</i>	<i>Conditions of Approval and/or Mitigation Measures and Responsible Land Use Department</i>	<i>Compliance or Monitoring Actions to be performed. Where applicable, a certified professional is required for action to be accepted. Timing</i>
PD003(A) – CULTURAL RESOURCES – NEGATIVE ARCHAEOLOGI CAL REPORT	<p>If, during the course of construction, cultural, archaeological, historical or paleontological resources are uncovered at the site (surface or subsurface resources) work shall be halted immediately within 50 meters (165 feet) of the find until a qualified professional archaeologist can evaluate it. Monterey County RMA - Planning and a qualified archaeologist (i.e., an archaeologist registered with the Register of Professional Archaeologists) shall be immediately contacted by the responsible individual present on-site. When contacted, the project planner and the archaeologist shall immediately visit the site to determine the extent of the resources and to develop proper mitigation measures required for the discovery. (RMA - Planning)</p>	<p>Stop work within 50 meters (165 feet) of uncovered resource and contact Monterey County RMA - Planning and a qualified archaeologist immediately if cultural, archaeological, historical or paleontological resources are uncovered. When contacted, the project planner and the archaeologist shall immediately visit the site to determine the extent of the resources and to develop proper mitigation measures required for the discovery.</p>
PDSP001 - ARCH WAIVER	<p>Applicant must abide by the limitations set in the attached archaeology report waiver. (RMA – Planning)</p>	<ol style="list-style-type: none"> 1. Grading or digging for a mud pit is not allowed under this waiver, if needed, the applicant shall use alternative measures. 2. The waiver is granted for drilling of the well only at the location shown on the attached site plan. No additional grading or excavation is authorized. 3. If any cultural resources or human remains are found during drilling of the well all work is to cease and an archaeologist approved by the County of Monterey shall be contracted to review the find and recommend appropriate action.



ARCHAEOLOGY REPORT WAIVER

Exhibit C

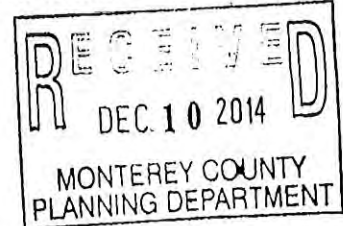
ASSOCIATED PERMIT NUMBER

WP #14-12460

ASSESSOR'S PARCEL NUMBER

229-011-021-000

DATE STAMP



The 2010 General Plan and the provisions of Chapter 21.66.050 C 1 of the Zoning Ordinance require the preparation of an archaeological report for development in certain areas. Your proposed project is located in an area of High or Moderate Archeological Sensitivity per our Department's database resource maps. The preparation of the archaeological report may be waived by the Director of Planning if any of the following circumstances are met.

The information you provide will be evaluated as part of the review of your application and the preparation of the archaeological report may be waived by the Director of Planning. If the report is waived, a note containing standard language would be required on the building permit plans giving notice that construction shall stop and that the County shall be notified immediately if archaeological resources are found during construction.

Owner Agent

OWNER/APPLICANT INFORMATION

PROJECT LOCATION:

Charles Benson Road, Marina GPS Coordinates: 36.715804, -121.7752559

NAME

Cascade Driling Inc

PHONE

909-946-1640

MAILING ADDRESS

1333 W. 9th Street

CITY/STATE

Upland, CA

ZIP

91786

FAX

E-MAIL

mromero@cascadedrilling.com

This waiver is approved based on:

- A previous archaeological report was prepared for the site by a qualified archaeologist, as included in the County's list of archaeological consultants or as a member of the Register of Professional Archaeologists; and the report clearly and adequately included (surveyed) the currently-proposed development site within its scope; or
- The proposed project does not involve land clearing or land disturbance; or
- The proposed project is a minor project on a previously disturbed site. **Please provide the information requested below;**

If the project is proposed in an area previously disturbed, please provide the following information:

1. The project involves the digging of a well at a location where there is clear surface evidence of prior surface disturbance (See attached photos showing the location of the proposed well and/or the location of the well to be removed.
2. Previously approved permit for grading in the area of the proposed development.

Limitations:

1. The waiver is granted for drilling of the well only at the location shown on the attached site plan. No additional grading or excavation is authorized.
2. Grading or digging for a mud pit is not allowed under this waiver, if needed, the applicant shall use alternative measures. If a mud pit is required, a Phase One Archaeology Assessment will need to be prepared by a County approved Archaeologist and submitted to RMA-Planning
3. If any cultural resources or human remains are found during drilling of the well all work is to cease and an archaeologist approved by the County of Monterey shall be contracted to review the find and recommend appropriate action.

<input checked="" type="checkbox"/> WAIVER APPROVED	 DIRECTOR OF PLANNING	DATE
<input type="checkbox"/> WAIVER DENIED		12/10/2014



MONITORING WELL PERMIT

PERMIT NO: 14-12461

-MONITORING WELL

-CONSTRUCTION

-PIEZOMETER

-DESTRUCTION

SITE LOCATION: W. Blanco Road (MW-6S, MW-6M, MW-6D)

APN #: 175-051-002-000

<p>SITE CONTACT PERSON: MARIO ROMERO</p> <p>PHONE: (909)946-1640</p>	<p>OWNER: CAL AM – IAN CROOKS 511 FOREST LODGE RD, STE 100 PACIFIC GROVE, CA 93950 PHONE: (831)646-3217</p>
<p>CONSULTANT:</p> <p>PHONE:</p>	<p>DRILLER: CASCADE DRILLING 1333 WEST 9TH STREET UPLAND, CA 91786 LICENSE #: C-57 938110 PHONE : (909)946-1640</p>

CONDITIONS:

1. All requirements set forth in Monterey Code Chapter 15.08 and Bulletins 74-81 and 74-90, shall be complied with at all times.
2. The well shall be at least 100 feet from any septic tank; any portion of any leach field or animal enclosure; 50 feet from any sewer main, line or lateral; and 150 feet from any seepage pit. If type of absorption field is unknown, the distance shall be 150 feet.
3. Location of the well shall not prevent the installation, relocation or expansion of the septic system on any adjoining lot.
4. Permit shall be kept on site at all times while work is in progress.
5. The well shall be drilled in the approved location and to the approved depths delineated on the attached map, Exhibit A. The well cannot be drilled in any other location without prior approval from Monterey County Health Department, Environmental Health Bureau (EHB) and receipt of an amended permit.
6. The well shall be constructed in accordance with the WRA approved floodproofing plan as described in Exhibit B.
7. Any well on the premises which is to be abandoned, or which has been abandoned shall be properly destroyed within six months of the completion of this well.

8. Notify the EHB at least 24 hours prior to moving on site.
9. Notify the EHB 24 hours prior to the time you expect to place any seal.
10. The sealing material shall be neat cement.
11. If the seal(s) cannot be witnessed by the EHB, a detailed, written description of the seal(s) shall be submitted to the EHB within ten days.
12. Surface construction features of the completed well shall be in accordance with the California Well Standards Bulletin 74-81 and Bulletin 74-90 Section 10.
13. The permit applicants shall indemnify and hold harmless the County and its officers, agents, and employees from actions or claims of any description brought on account of any injury or damages sustained, by any person or property resulting from the issuance of the permit and the conduct of the activities authorized under said permit.
14. Issuance of this permit to construct a well does not create, transfer, assign or acknowledge any legal rights to water associated with this property.
15. Submit a Well Completion Report within 60 days upon completion.

DATE ISSUED: 1/16/2015

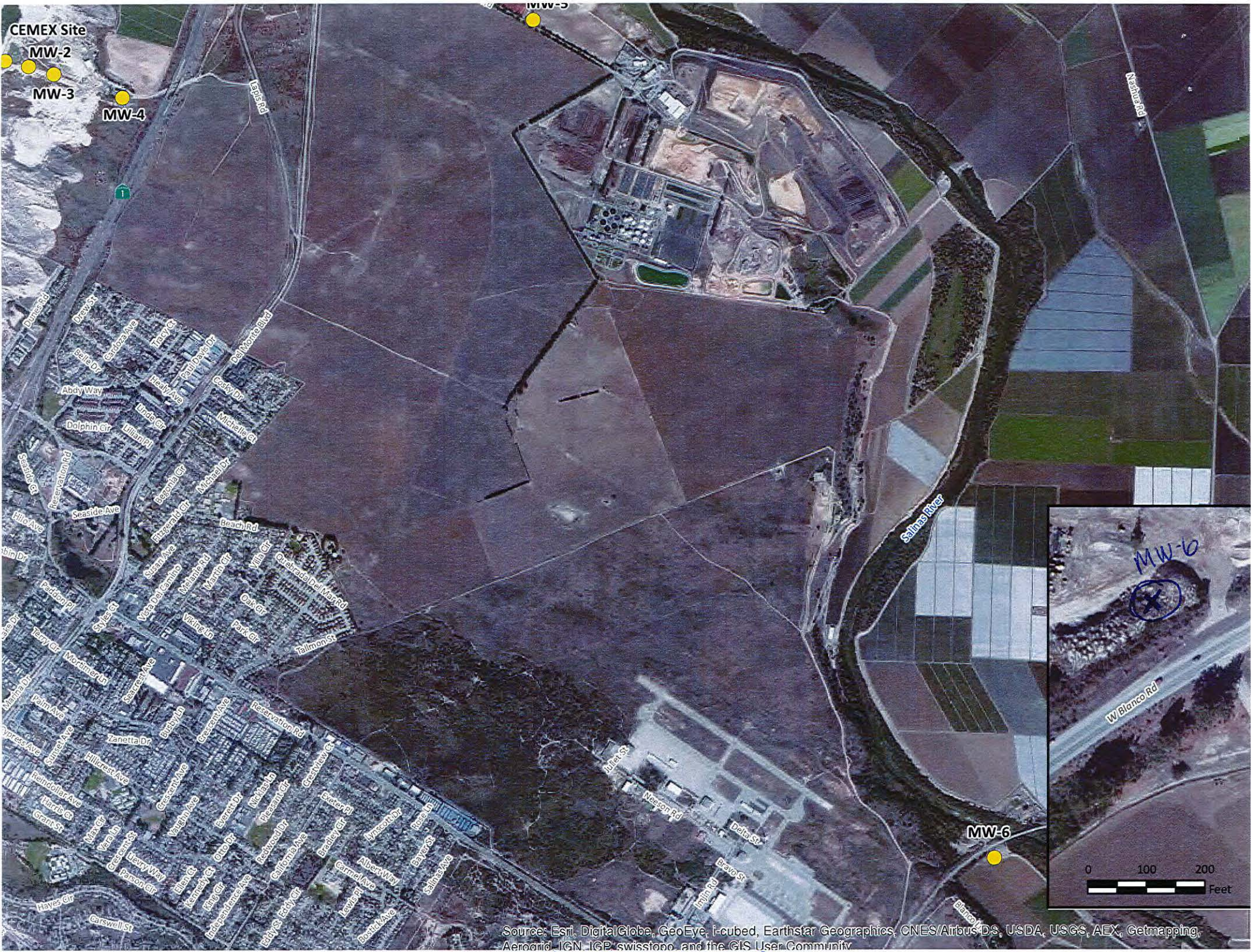
EXPIRATION DATE: 1/16/2016

ISSUED BY:



Marni Flagg, REHS
Senior Environmental Health Specialist

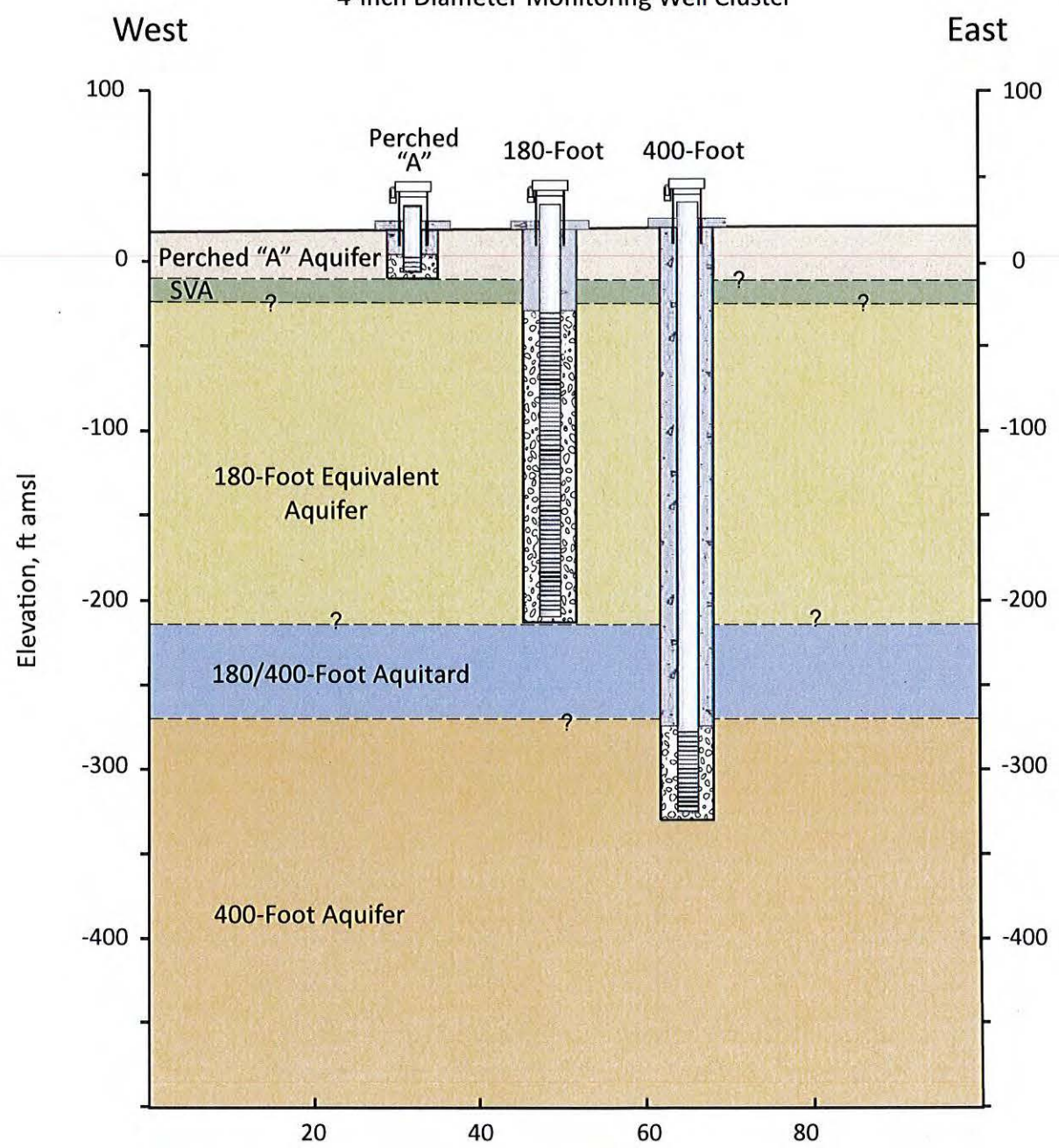
(Rev. 1/04,10/13)



Source: Esri, DigitalGlobe, GeoEye, i-cubed, Earthstar Geographics, CNES/Airbus DS, USDA, USGS, AEX, Getmapping, Aerogrid, IGN, IGP, swisstopo, and the GIS User Community

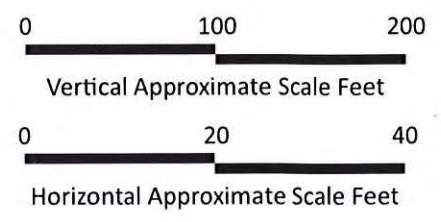
14-12461 Exhibit A

4-Inch Diameter Monitoring Well Cluster



Geologic Units

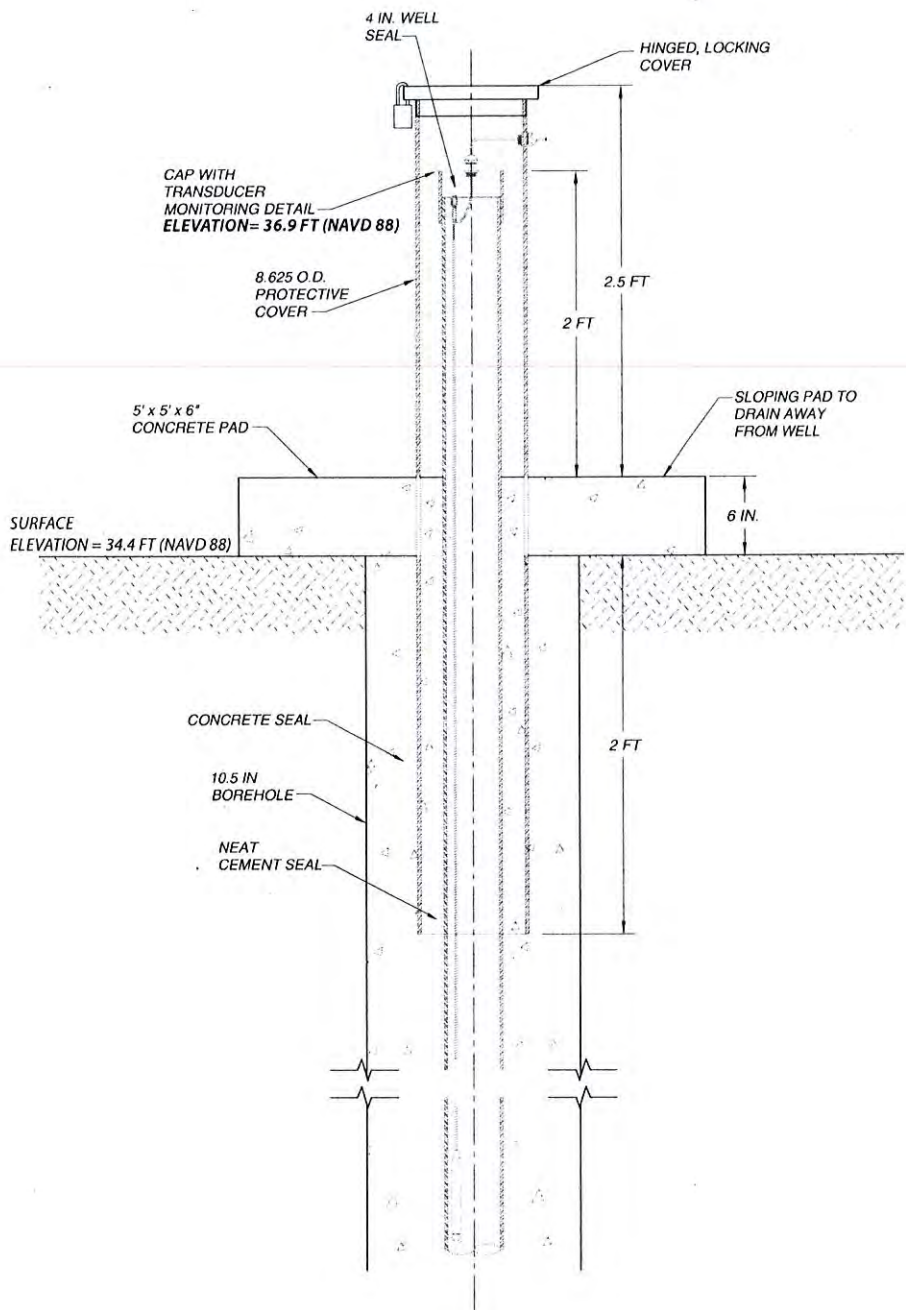
- Perched "A" Aquifer
- Salinas Valley Aquitard
- 180-Foot Equivalent Aquifer
- 180/400-Foot Aquitard
- 400-Foot Aquifer
- Geologic Contact (approximate)



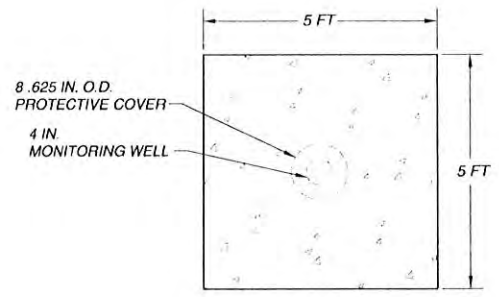
Source of Lithology: GEOSCIENCE (2014)
Well dimensions not to scale.

DRAFT

<p>GEOSCIENCE</p> <p><small>GEOSCIENCE Support Services, Inc. P.O. Box 220, Claremont, CA 91711 Tel: (909) 369-0707 Fax: (909) 629-9400 E-mail: anna@geoscience-wr.com</small></p>	<p>CALIFORNIA AMERICAN WATER/RBF CONSULTING</p> <p>PRELIMINARY MONITORING WELL DESIGN</p> <p>MONTEREY PENINSULA LANDFILL AREA</p>	<p>Figure</p> <p>2</p>
<p>Date: 24-Nov-14</p>		



PROFILE
NOT TO SCALE



PLAN
NOT TO SCALE

<p>GEOSCIENCE</p> <p>SETTING THE STANDARD IN WATER WELL DESIGN SINCE 1978</p> <p>909.451.6650 gssiwater.com</p>	<p>MONTEREY PENINSULA WATER SUPPLY PROJECT</p>	<p>Date: 16-DEC-14</p>	<p>FIGURE</p> <p style="text-align: center; font-size: 24pt;">3</p>
	<p>PRELIMINARY MONITORING WELL DESIGN (MW-6)</p>	<p>Designed: MDW</p>	
	<p>MONITORING WELL WELLHEAD DETAIL - MONUMENT COVER AND WELL PAD</p>	<p>Checked: DEW</p>	
		<p>File: MSL CLAM 04 4.dwg</p>	



MONITORING WELL PERMIT

PERMIT NO: 15-12483

-MONITORING WELL

-CONSTRUCTION

-PIEZOMETER

-DESTRUCTION

SITE LOCATION: Lapis Rd, Monterey County ROW (MW-7S, MW-7M, MW-7D)

APN #: N/A

<p><i>SITE CONTACT PERSON:</i> MARIO ROMERO</p> <p><i>PHONE:</i> (909)946-1640</p>	<p><i>OWNER:</i> CAL AM – IAN CROOKS 511 FOREST LODGE RD, STE 100 PACIFIC GROVE, CA 93950</p> <p><i>PHONE:</i> (831)646-3217</p>
<p><i>CONSULTANT:</i> MAKROM SHATILA</p> <p><i>PHONE:</i> 858-401-2268</p>	<p><i>DRILLER:</i> CASCADE DRILLING 1333 WEST 9TH STREET UPLAND, CA 91786</p> <p><i>LICENSE #:</i> C-57 938110 <i>PHONE :</i> (909)946-1640</p>

CONDITIONS:

1. All requirements set forth in Monterey Code Chapter 15.08 and Bulletins 74-81 and 74-90, shall be complied with at all times.
2. The well shall be at least 100 feet from any septic tank; any portion of any leach field or animal enclosure; 50 feet from any sewer main, line or lateral; and 150 feet from any seepage pit. If type of absorption field is unknown, the distance shall be 150 feet.
3. Location of the well shall not prevent the installation, relocation or expansion of the septic system on any adjoining lot.
4. Permit shall be kept on site at all times while work is in progress.
5. The well shall be drilled in the approved location delineated on the attached map, Exhibit A. The well cannot be drilled in any other location without prior approval from Monterey County Health Department, Environmental Health Bureau (EHB) and receipt of an amended permit.
6. The well shall be constructed per attached design, Exhibit B.
7. Any well on the premises which is to be abandoned, or which has been abandoned shall be properly destroyed within six months of the completion of this well.

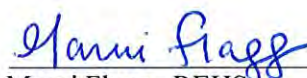
8. Notify the EHB at least 24 hours prior to moving on site.
9. Notify the EHB 24 hours prior to the time you expect to place any seal.
10. The sealing material shall be neat cement.
11. If the seal(s) cannot be witnessed by the EHB, a detailed, written description of the seal(s) shall be submitted to the EHB within ten days.
12. Surface construction features of the completed well shall be in accordance with the California Well Standards Bulletin 74-81 and Bulletin 74-90 Section 10.
13. The permit applicants shall indemnify and hold harmless the County and its officers, agents, and employees from actions or claims of any description brought on account of any injury or damages sustained, by any person or property resulting from the issuance of the permit and the conduct of the activities authorized under said permit.
14. *The applicant and contractor must abide by all of the requirements in the Costal Permit File #PLN150261, Exhibit C.
15. Issuance of this permit to construct a well does not create, transfer, assign or acknowledge any legal rights to water associated with this property.
16. Submit a Well Completion Report within 60 days upon completion.

***Exhibit C:** Questions regarding this conditions can be directed to RMA-Planning Department, 755-6414

DATE ISSUED: 6/26/2015

EXPIRATION DATE: 6/26/2016

ISSUED BY:



Marni Flagg, REHS
Supervising Environmental Health Specialist

(Rev. 1/04,10/13)

15-12483

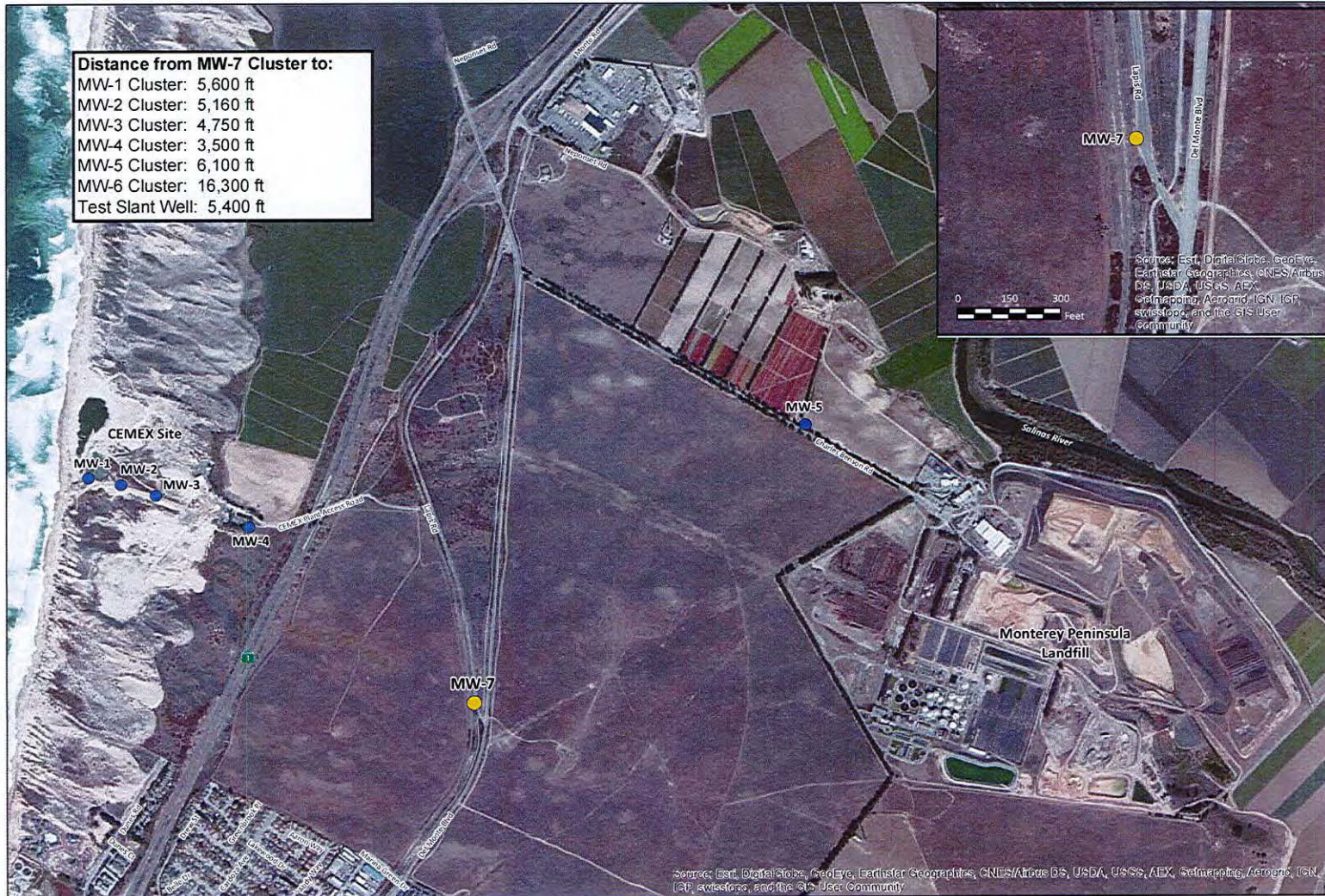
Exhibit A

CALIFORNIA AMERICAN WATER / RBF CONSULTING

TECHNICAL SPECIFICATIONS - MW-7 MONITORING WELLS
MONTEREY PENINSULA WATER SUPPLY PROJECT

Distance from MW-7 Cluster to:

- MW-1 Cluster: 5,600 ft
- MW-2 Cluster: 5,160 ft
- MW-3 Cluster: 4,750 ft
- MW-4 Cluster: 3,500 ft
- MW-5 Cluster: 6,100 ft
- MW-6 Cluster: 16,300 ft
- Test Slant Well: 5,400 ft



PROPOSED MONITORING WELL LOCATIONS

- EXPLANATION**
- MW-7 ● Proposed Monitoring Well Location
 - MW-5 ● Completed / In-Progress Monitoring Well Location

Source: Esri, DigitalGlobe, GeoEye, Earthstar Geographics, CNES/Airbus DS, USDA, USGS, AeroX, IGN, IGP, swisstopo, and the GIS User Community

6-Feb-15
 Prepared by: DWB. Map Projection: State Plane 1983, Zone IV.
 © 2015, GEOSCIENCE Support Services, Inc. All rights reserved.

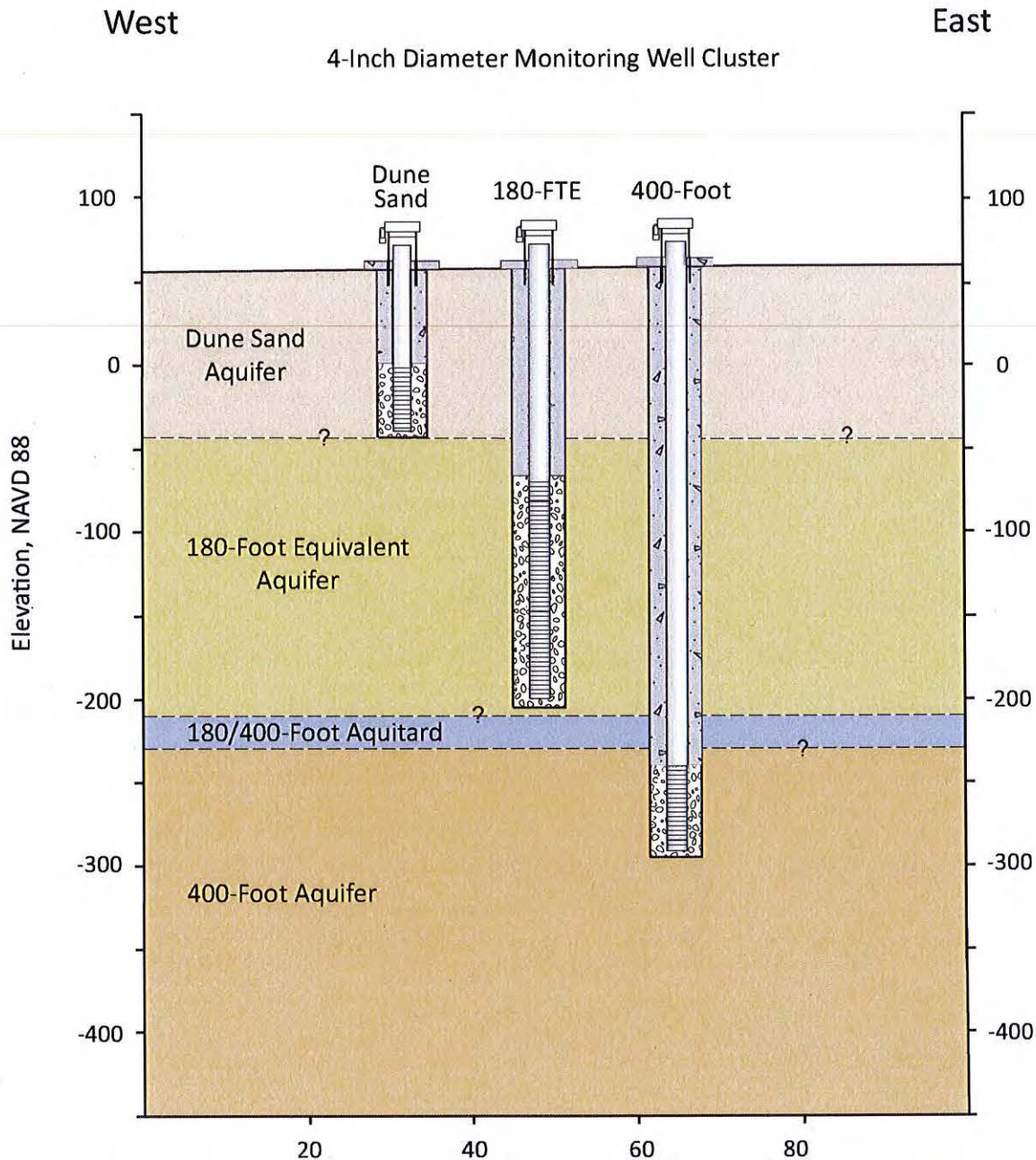


DRAFT

GEOSCIENCE
 GEOSCIENCE Support Services, Inc.
 P.O. Box 220, Claremont, CA 91711
 Tel: (909) 451-6650 Fax: (909) 451-6638
 www.gswater.com

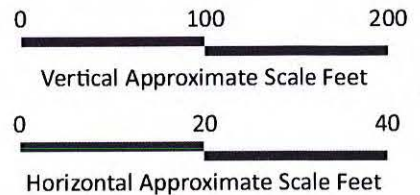
Figure 1

GIS_proj/mcwp_cal_am/rbf_MW7_techspecs_2-15/0_MW7specs_Fig_1_MW7_well_loc_2-15.mxd



Geologic Units

- Dune Sand Aquifer
- 180/400-Foot Aquitard
- 180-Foot Equivalent Aquifer
- 400-Foot Aquifer
- Geologic Contact (approximate)



Source of Lithology: GEOSCIENCE (2014)
Well dimensions not to scale.

DRAFT

<p>GEOSCIENCE <small>GEOSCIENCE Support Services, Inc. P.O. Box 220, Clearmont, CA 91711 Tel: (909) 920-0707 Fax: (909) 920-0403 E-mail: email@geoscience-water.com</small></p>	<p>CALIFORNIA AMERICAN WATER/RBF CONSULTING</p> <p>PRELIMINARY MONITORING WELL DESIGN - MW-7 CLUSTER</p> <p>LAPIS RD. AND DEL MONTE BLVD. NEAR MARINA, CA</p>	<p>Figure</p> <p>2</p>
<p>Date: 5-Feb-15</p>		

Monterey County RMA Planning
Conditions of Approval/Implementation Plan/Mitigation Monitoring
and Reporting Plan

PLN150261

1. PD001 - SPECIFIC USES ONLY

Responsible Department: RMA-Planning

Condition/Mitigation Monitoring Measure: This Coastal Administrative permit (PLN150261) allows the construction of three monitoring wells. The property is located in the County right of way on Lapis Road, Marina. (Adjacent to Assessor's Parcel Number 203-011-021-000), North County Land Use Plan. This permit was approved in accordance with County ordinances and land use regulations subject to the terms and conditions described in the project file. The term "Applicant" or "Owner/Applicant" as used in these conditions means California-American Water and its successors and assigns. Neither the uses nor the construction allowed by this permit shall commence unless and until all of the conditions of this permit are met to the satisfaction of the Director of RMA - Planning. Any use or construction not in substantial conformance with the terms and conditions of this permit is a violation of County regulations and may result in modification or revocation of this permit and subsequent legal action. No use or construction other than that specified by this permit is allowed unless additional permits are approved by the appropriate authorities. To the extent that the County has delegated any condition compliance or mitigation monitoring to the Monterey County Water Resources Agency, the Water Resources Agency shall provide all information requested by the County and the County shall bear ultimate responsibility to ensure that conditions and mitigation measures are properly fulfilled. (RMA - Planning)

Compliance or Monitoring Action to be Performed: The Owner/Applicant shall adhere to conditions and uses specified in the permit on an ongoing basis unless otherwise stated.

2. PD004 - INDEMNIFICATION AGREEMENT

Responsible Department: RMA-Planning

Condition/Mitigation Monitoring Measure: The applicant agrees as a condition and in consideration of approval of this discretionary development permit that it will, pursuant to agreement and/or statutory provisions as applicable, including but not limited to Government Code Section 66474.9, defend, indemnify and hold harmless the County of Monterey or its agents, officers and employees from any claim, action or proceeding against the County or its agents, officers or employees to attack, set aside, void or annul this approval, which action is brought within the time period provided for under law, including but not limited to, Government Code Section 66499.37, as applicable. The applicant will reimburse the County for any court costs and attorney's fees which the County may be required by a court to pay as a result of such action. The County may, at its sole discretion, participate in the defense of such action; but such participation shall not relieve applicant of his/her/its obligations under this condition. The County shall promptly notify the applicant of any such claim, action or proceeding and the County shall cooperate fully in the defense thereof. If the County fails to promptly notify the applicant of any such claim, action or proceeding or fails to cooperate fully in the defense thereof, the applicant shall not thereafter be responsible to defend, indemnify or hold the County harmless. (RMA - Planning)

Compliance or Monitoring Action to be Performed: Upon demand of County Counsel or prior to issuance of a water well drilling permit, whichever occurs first and as applicable, the Owner/Applicant shall submit a signed and notarized Indemnification Agreement to the Director of RMA-Planning for review and signature by the County.

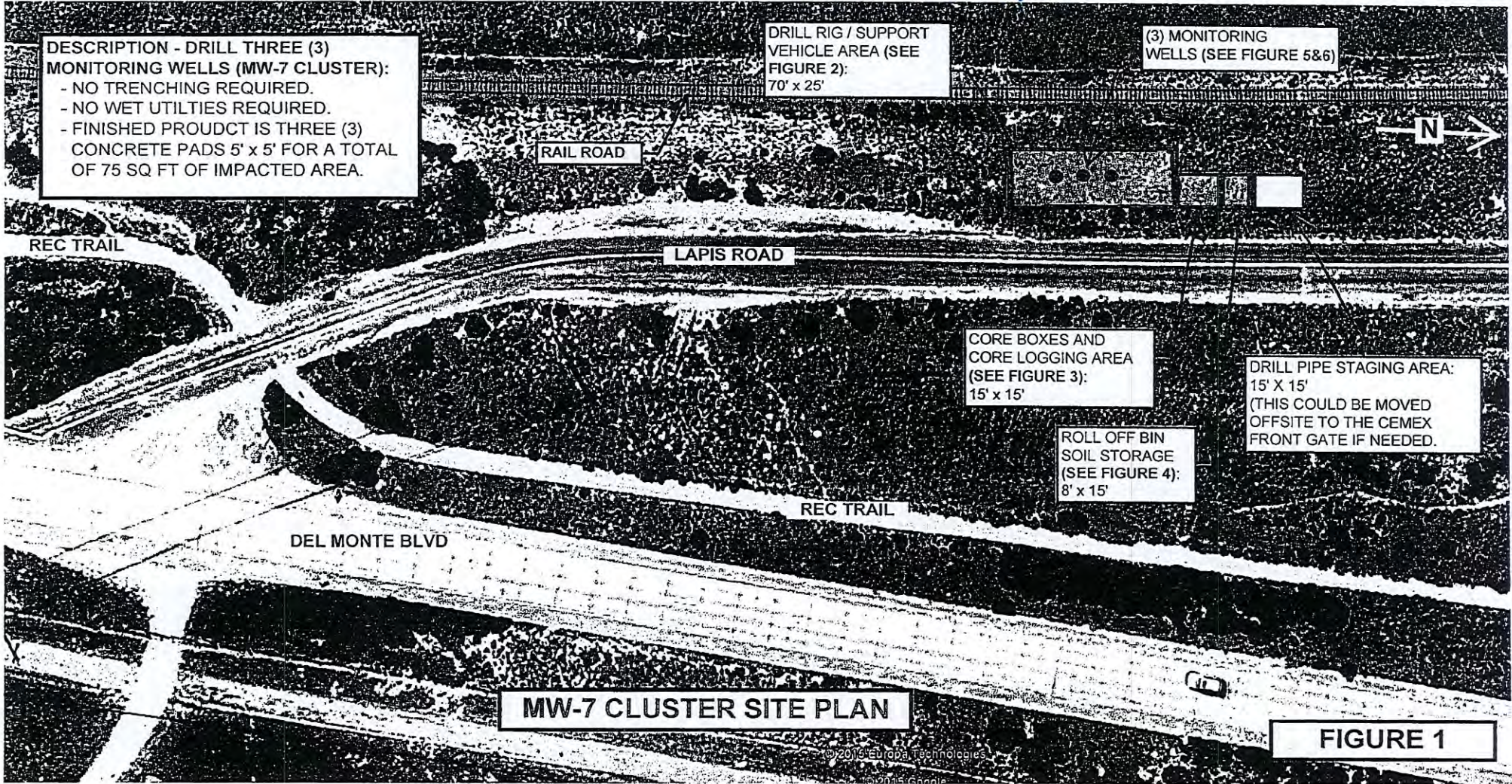
3. PD003(A) - CULTURAL RESOURCES NEGATIVE ARCHAEOLOGICAL REPORT

Responsible Department: RMA-Planning

Condition/Mitigation Monitoring Measure: If, during the course of construction, cultural, archaeological, historical or paleontological resources are uncovered at the site (surface or subsurface resources) work shall be halted immediately within 50 meters (165 feet) of the find until a qualified professional archaeologist can evaluate it. Monterey County RMA - Planning and a qualified archaeologist (i.e., an archaeologist registered with the Register of Professional Archaeologists) shall be immediately contacted by the responsible individual present on-site. When contacted, the project planner and the archaeologist shall immediately visit the site to determine the extent of the resources and to develop proper mitigation measures required for recovery. (RMA - Planning)

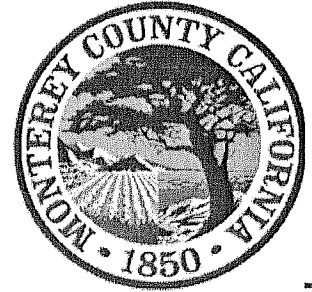
Compliance or Monitoring Action to be Performed: The Owner/Applicant shall adhere to this condition on an on-going basis. Prior to the issuance of a water well drilling permit, the Owner/Applicant shall ensure that the requirements of this condition are included on all water well drilling permits. The note shall state "Stop work within 50 meters (165 feet) of uncovered resource and contact Monterey County RMA - Planning and a qualified archaeologist immediately if cultural, archaeological, historical or paleontological resources are uncovered."

When contacted, the project planner and the archaeologist shall immediately visit the site to determine the extent of the resources and to develop proper mitigation measures required for the discovery.



PLN150261

MONTEREY COUNTY HEALTH DEPARTMENT
 ENVIRONMENTAL HEALTH BUREAU
 1270 Natividad Road, Salinas, CA 93906
 Office (831) 755-4507 Fax (831)796-8691



MONITORING WELL PERMIT

PERMIT NO: 15-12502

- | | |
|--|---|
| <input checked="" type="checkbox"/> -MONITORING WELL | <input checked="" type="checkbox"/> -CONSTRUCTION |
| <input type="checkbox"/> -PIEZOMETER | <input type="checkbox"/> -DESTRUCTION |

SITE LOCATION: Monte Rd, Monterey County ROW (MW-8S, MW-8M, MW-8D)
APN #: N/A

SITE CONTACT PERSON: MARIO ROMERO PHONE: (909)946-1640	OWNER: CAL AM – IAN CROOKS 511 FOREST LODGE RD, STE 100 PACIFIC GROVE, CA 93950 PHONE: (831)646-3217
CONSULTANT: PHONE:	DRILLER: CASCADE DRILLING 1333 WEST 9 TH STREET UPLAND, CA 91786 LICENSE #: C-57 938110 PHONE : (909)946-1640

CONDITIONS:

1. All requirements set forth in Monterey Code Chapter 15.08 and Bulletins 74-81 and 74-90, shall be complied with at all times.
2. The well shall be at least 100 feet from any septic tank; any portion of any leach field or animal enclosure; 50 feet from any sewer main, line or lateral; and 150 feet from any seepage pit. If type of absorption field is unknown, the distance shall be 150 feet.
3. Location of the well shall not prevent the installation, relocation or expansion of the septic system on any adjoining lot.
4. Permit shall be kept on site at all times while work is in progress.
5. The well shall be drilled in the approved location delineated on the attached map, Exhibit A. The well cannot be drilled in any other location without prior approval from Monterey County Health Department, Environmental Health Bureau (EHB) and receipt of an amended permit.
6. The well shall be constructed per attached design, Exhibit B.
7. Any well on the premises which is to be abandoned, or which has been abandoned shall be properly destroyed within six months of the completion of this well.

8. Notify the EHB at least 24 hours prior to moving on site.
9. Notify the EHB 24 hours prior to the time you expect to place any seal.
10. The sealing material shall be neat cement.
11. If the seal(s) cannot be witnessed by the EHB, a detailed, written description of the seal(s) shall be submitted to the EHB within ten days.
12. Surface construction features of the completed well shall be in accordance with the California Well Standards Bulletin 74-81 and Bulletin 74-90 Section 10.
13. The permit applicants shall indemnify and hold harmless the County and its officers, agents, and employees from actions or claims of any description brought on account of any injury or damages sustained, by any person or property resulting from the issuance of the permit and the conduct of the activities authorized under said permit.
14. *If, during the course of construction, cultural, archaeological, historical or paleontological resources are uncovered at the site (surface or subsurface resources) work shall be halted immediately within 50 meters (165 feet) of the find until a qualified professional archaeologist can evaluate it. Monterey County RMA - Planning and a qualified archaeologist (i.e., an archaeologist registered with the Register of Professional Archaeologists) shall be immediately contacted by the responsible individual present on-site. When contacted, the project planner and the archaeologist shall immediately visit the site to determine the extent of the resources and to develop proper mitigation measures required for the discovery. See **Exhibit C**.
15. * Proposed well site has been issued the attached archeological waiver, **Exhibit D**. The construction must meet the limitations in the attached archeological waiver.
16. Issuance of this permit to construct a well does not create, transfer, assign or acknowledge any legal rights to water associated with this property.
17. Submit a Well Completion Report within 60 days upon completion.

***Exhibit C and D**: Questions regarding these conditions can be directed to RMA-Planning Department, 755-6414

DATE ISSUED: 4/10/2015

EXPIRATION DATE: 4/10/2016

ISSUED BY:



Marni Flagg, REHS
Supervising Environmental Health Specialist

(Rev. 1/04,10/13)





15-12502 Exhibit A

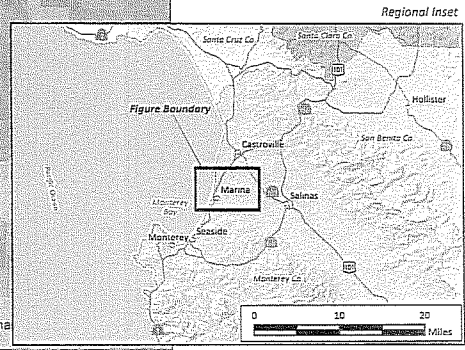
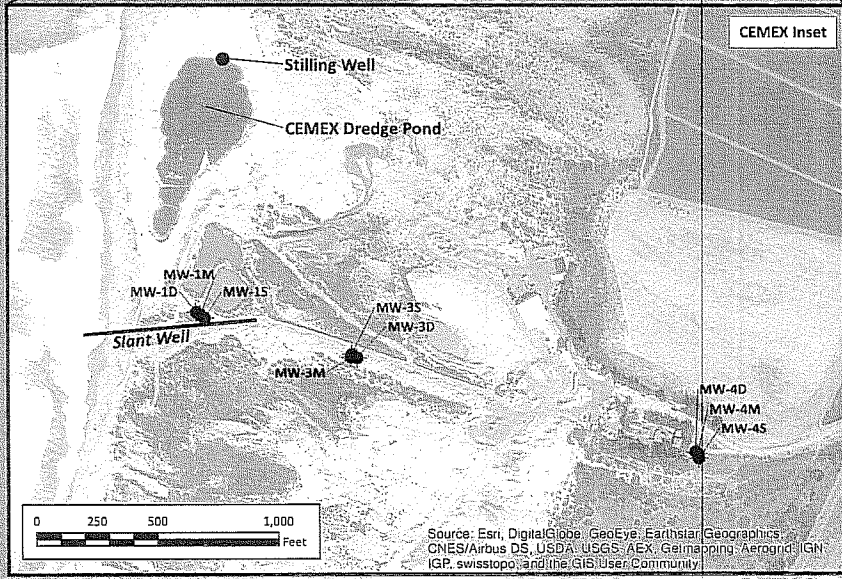
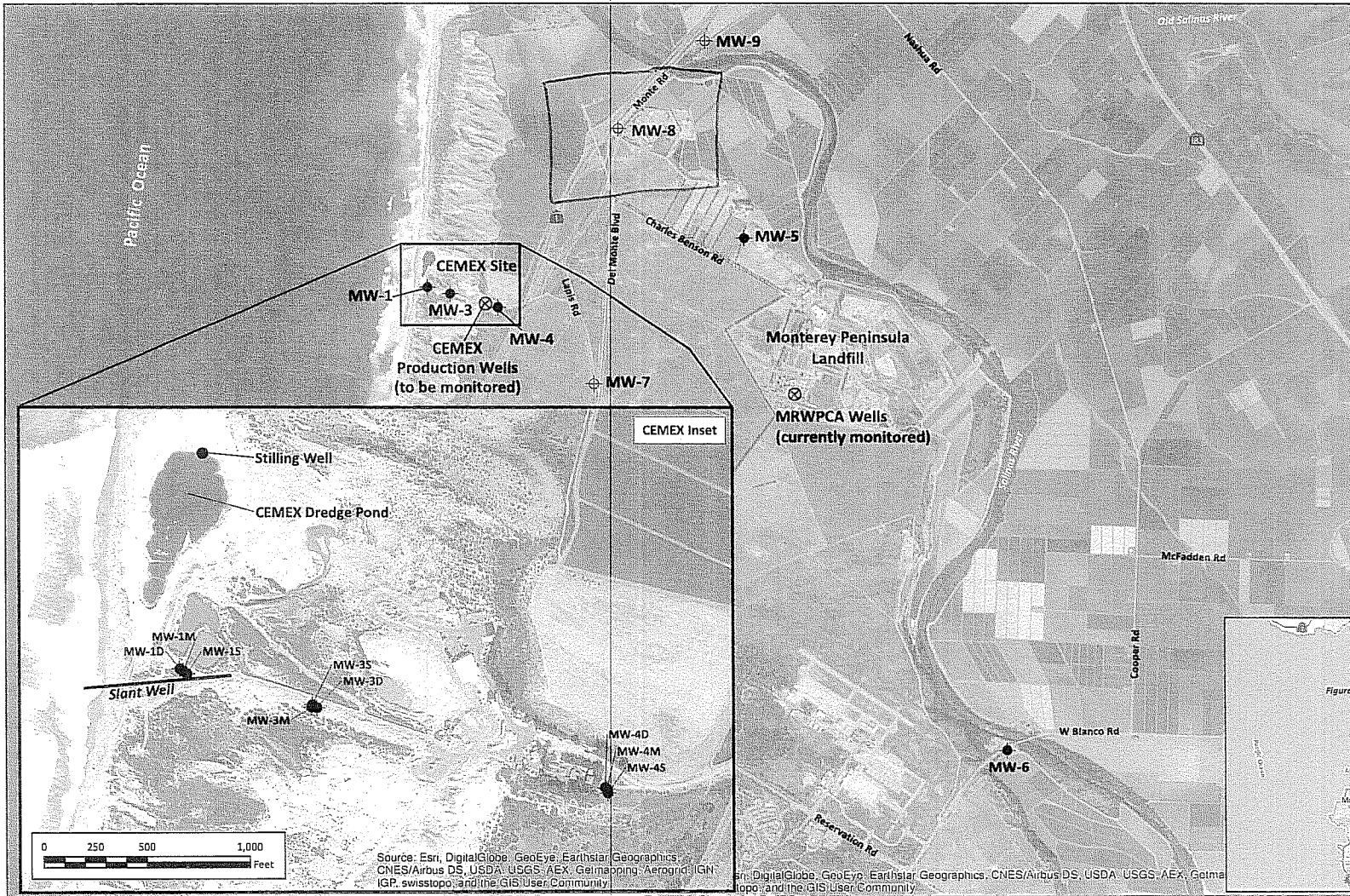
CALIFORNIA AMERICAN WATER

MONTEREY PENINSULA WATER SUPPLY PROJECT

**EXISTING AND PROPOSED
MONITORING WELL
LOCATIONS**

EXPLANATION

-  Existing Monitoring Well Cluster
-  Proposed Monitoring Well Cluster
-  Existing Production Well
-  Slant Well



Source: Esri, DigitalGlobe, GeoEye, Earthstar Geographics, CNES/Airbus DS, USDA, USGS, AEX, Geomatics, AeroGRID, IGN, IGP, swisstopo, and the GIS User Community

Source: Esri, DigitalGlobe, GeoEye, Earthstar Geographics, CNES/Airbus DS, USDA, USGS, AEX, Geomatics, AeroGRID, IGN, IGP, swisstopo, and the GIS User Community

24-Mar-15

Prepared by: QWB. Map Projection: State Plane 1983, Zone IV.

© 2015, GEOSCIENCE Support Services, Inc. All rights reserved.

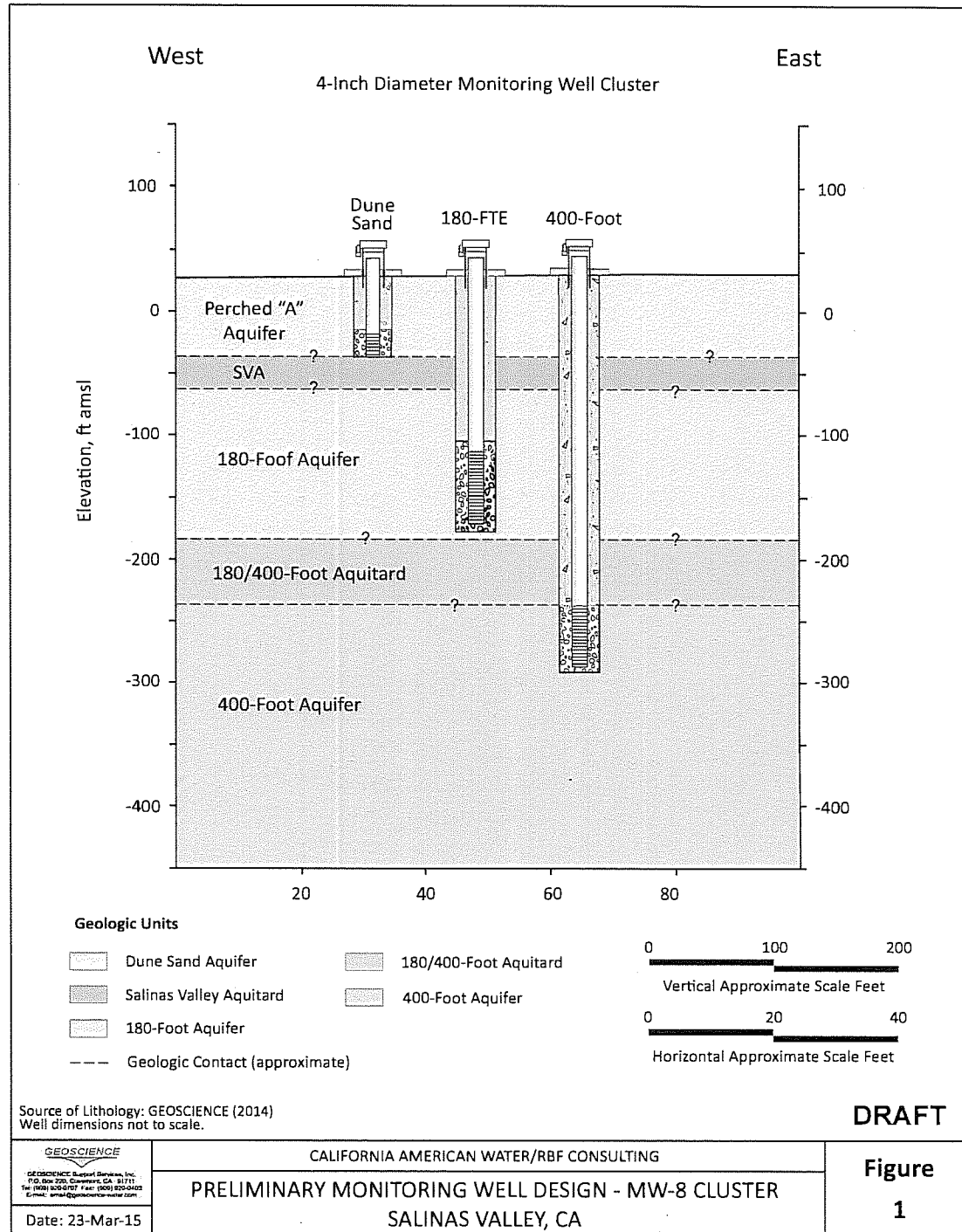


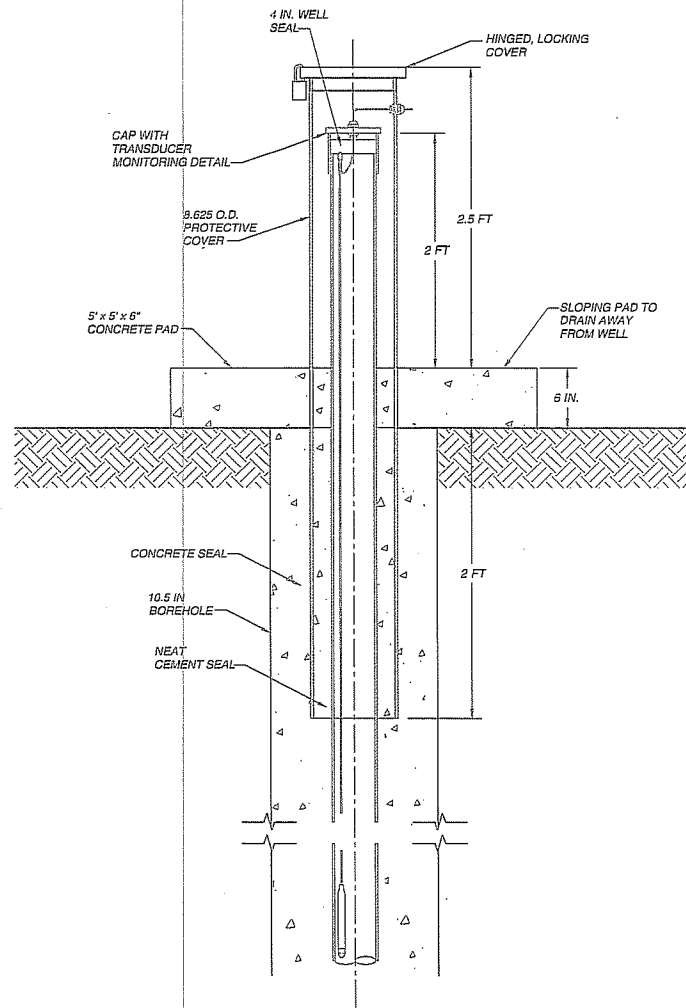
GEOSCIENCE

GEOSCIENCE Support Services, Inc.
P.O. Box 220, Clearmont, CA 91711
Tel: (909) 451-6650 Fax: (909) 451-6638
www.geosint.com

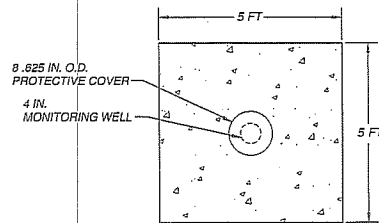
Figure 1

15-12502
Exhibit B pg 1





PROFILE
NOT TO SCALE



PLAN
NOT TO SCALE

DRAFT

<p>GEOSCIENCE</p> <p>SETTING THE STANDARD IN WATER WELL DESIGN SINCE 1979[®]</p> <p>303-451-8550 gswwater.com</p>	MONTEREY PENINSULA WATER SUPPLY PROJECT	Date:	FIGURE
	PRELIMINARY MONITORING WELL DESIGN	Designed: MDW	3
	MONITORING WELL WELLHEAD DETAIL - MONUMENT COVER AND WELL PAD	Checked: DEW	
		File: 1502-CL-011-04-1.dwg	

RESOURCE MANAGEMENT AGENCY - PLANNING <u>CONDITION COMPLIANCE & MITIGATION MONITORING AND</u> <u>REPORTING PLAN</u>	PROJECT NAME: CAL-AM <u>File No: #15-12502</u> <u>Approval by: Grace Bogdan</u>	<u>APNs: COUNTY ROW</u> <u>Date: April 10, 2015</u>
--	--	--

**Monitoring or Reporting refers to projects with an EIR or adopted Mitigated Negative Declaration per Section 21081.6 of the Public Resources Code.*

<i>Permit Cond. Number</i>	<i>Conditions of Approval and/or Mitigation Measures and Responsible Land Use Department</i>	<i>Compliance or Monitoring Actions to be performed. Where applicable, a certified professional is required for action to be accepted. Timing</i>
--------------------------------	--	---

PD003(A) – CULTURAL RESOURCES – NEGATIVE ARCHAEOLOGI CAL REPORT	<p>If, during the course of construction, cultural, archaeological, historical or paleontological resources are uncovered at the site (surface or subsurface resources) work shall be halted immediately within 50 meters (165 feet) of the find until a qualified professional archaeologist can evaluate it. Monterey County RMA - Planning and a qualified archaeologist (i.e., an archaeologist registered with the Register of Professional Archaeologists) shall be immediately contacted by the responsible individual present on-site. When contacted, the project planner and the archaeologist shall immediately visit the site to determine the extent of the resources and to develop proper mitigation measures required for the discovery. (RMA - Planning)</p>	<p>Stop work within 50 meters (165 feet) of uncovered resource and contact Monterey County RMA - Planning and a qualified archaeologist immediately if cultural, archaeological, historical or paleontological resources are uncovered. When contacted, the project planner and the archaeologist shall immediately visit the site to determine the extent of the resources and to develop proper mitigation measures required for the discovery.</p>
PDSP001 - ARCH WAIVER	<p>Applicant must abide by the limitations set in the attached archaeology report waiver. (RMA – Planning)</p>	<ol style="list-style-type: none"> 1. The waiver is granted for drilling of the well only at the location shown on the attached site plan. No additional grading or excavation is authorized. 2. If any cultural resources or human remains are found during drilling of the well all work is to cease and an archaeologist approved by the County of Monterey shall be contracted to review the find and recommend appropriate action.



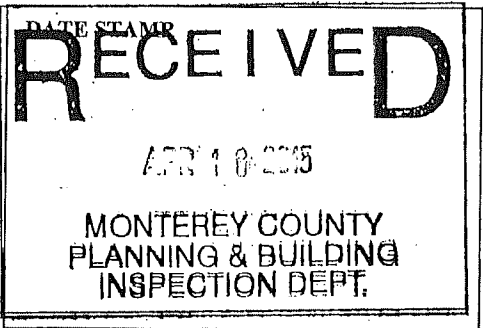
ARCHAEOLOGY REPORT WAIVER

ASSOCIATED PERMIT NUMBER Well Permit #15-12502

ASSESSOR'S PARCEL NUMBER - N/A
COUNTY ROW

The 2010 General Plan and the provisions of Chapter 21.66.050 C 1 of the Zoning Ordinance require the preparation of an archaeological report for development in certain areas. Your proposed project is located in an area of High or Moderate Archeological Sensitivity per our Department's database resource maps. The preparation of the archaeological report may be waived by the Director of Planning if any of the following circumstances are met.

The information you provide will be evaluated as part of the review of your application and the preparation of the archaeological report may be waived by the Director of Planning. If the report is waived, a note containing standard language would be required on the building permit plans giving notice that construction shall stop and that the County shall be notified immediately if archaeological resources are found during construction.



OWNER/APPLICANT INFORMATION

Owner Agent

PROJECT LOCATION: Between Neponset Road & Nashua Road GPS Coordinates: 36.726387, -121.787491		
NAME Cascade Drilling, Inc	PHONE (909)946-1640	
MAILING ADDRESS 1333 W. 9 th Street	CITY/STATE Upland, CA	ZIP 91786
FAX	E-MAIL mromero@cascadedrilling.com	

This waiver is approved based on:

- A previous archaeological report was prepared for the site by a qualified archaeologist, as included in the County's list of archaeological consultants or as a member of the Register of Professional Archaeologists and the report clearly and adequately included (surveyed) the currently-proposed development site within its scope; or
- The proposed project does not involve land clearing or land disturbance; or
- The proposed project is a minor project on a previously disturbed site. **Please provide the information requested below;**
- Other acceptable evidence from a professional archaeologist.

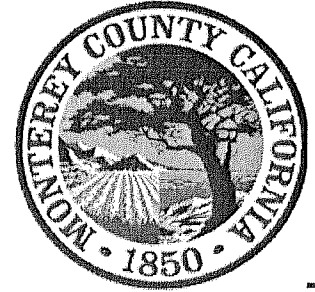
If the project is proposed in an area previously disturbed, please provide the following information:

1. The project involves the digging of a well at a location where there is clear surface evidence of prior surface disturbance (See attached photos showing the location of the proposed well and/or the location of the well to be removed).
2. Previously approved permit for grading in the area of the proposed development.

Limitations:

1. The waiver is granted for drilling of the well only at the location shown on the attached site plan.
2. If any cultural resources or human remains are found during drilling of the well all work is to cease and an archaeologist approved by the County of Monterey shall be contracted to review the find and recommend appropriate action.

<input checked="" type="checkbox"/> WAIVER APPROVED		DATE 4/10/2015
<input type="checkbox"/> WAIVER DENIED		



MONITORING WELL PERMIT

PERMIT NO: 15-12503

- MONITORING WELL -CONSTRUCTION
-PIEZOMETER -DESTRUCTION

SITE LOCATION: Monte Rd, Monterey County ROW (MW-9S, MW-9M, MW-9D)
APN #: N/A

<p>SITE CONTACT PERSON: MARIO ROMERO</p> <p>PHONE: (909)946-1640</p>	<p>OWNER: CAL AM – IAN CROOKS 511 FOREST LODGE RD, STE 100 PACIFIC GROVE, CA 93950</p> <p>PHONE: (831)646-3217</p>
<p>CONSULTANT:</p> <p>PHONE:</p>	<p>DRILLER: CASCADE DRILLING 1333 WEST 9TH STREET UPLAND, CA 91786</p> <p>LICENSE #: C-57 938110 PHONE : (909)946-1640</p>

CONDITIONS:

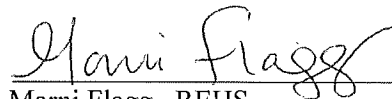
1. All requirements set forth in Monterey Code Chapter 15.08 and Bulletins 74-81 and 74-90, shall be complied with at all times.
2. The well shall be at least 100 feet from any septic tank; any portion of any leach field or animal enclosure; 50 feet from any sewer main, line or lateral; and 150 feet from any seepage pit. If type of absorption field is unknown, the distance shall be 150 feet.
3. Location of the well shall not prevent the installation, relocation or expansion of the septic system on any adjoining lot.
4. Permit shall be kept on site at all times while work is in progress.
5. The well shall be drilled in the approved location delineated on the attached map, Exhibit A. The well cannot be drilled in any other location without prior approval from Monterey County Health Department, Environmental Health Bureau (EHB) and receipt of an amended permit.
6. The well shall be constructed per attached design, Exhibit B.
7. Any well on the premises which is to be abandoned, or which has been abandoned shall be properly destroyed within six months of the completion of this well.

8. Notify the EHB at least 24 hours prior to moving on site.
9. Notify the EHB 24 hours prior to the time you expect to place any seal.
10. The sealing material shall be neat cement.
11. If the seal(s) cannot be witnessed by the EHB, a detailed, written description of the seal(s) shall be submitted to the EHB within ten days.
12. Surface construction features of the completed well shall be in accordance with the California Well Standards Bulletin 74-81 and Bulletin 74-90 Section 10.
13. The permit applicants shall indemnify and hold harmless the County and its officers, agents, and employees from actions or claims of any description brought on account of any injury or damages sustained, by any person or property resulting from the issuance of the permit and the conduct of the activities authorized under said permit.
14. Issuance of this permit to construct a well does not create, transfer, assign or acknowledge any legal rights to water associated with this property.
15. Submit a Well Completion Report within 60 days upon completion.

DATE ISSUED: 4/10/2015

EXPIRATION DATE: 4/10/2016

ISSUED BY:



Marni Flagg, REHS
Supervising Environmental Health Specialist

(Rev. 1/04,10/13)

15-12503 Exhibit A

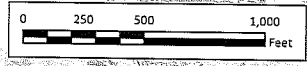
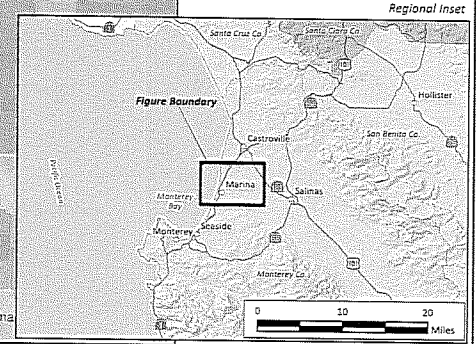
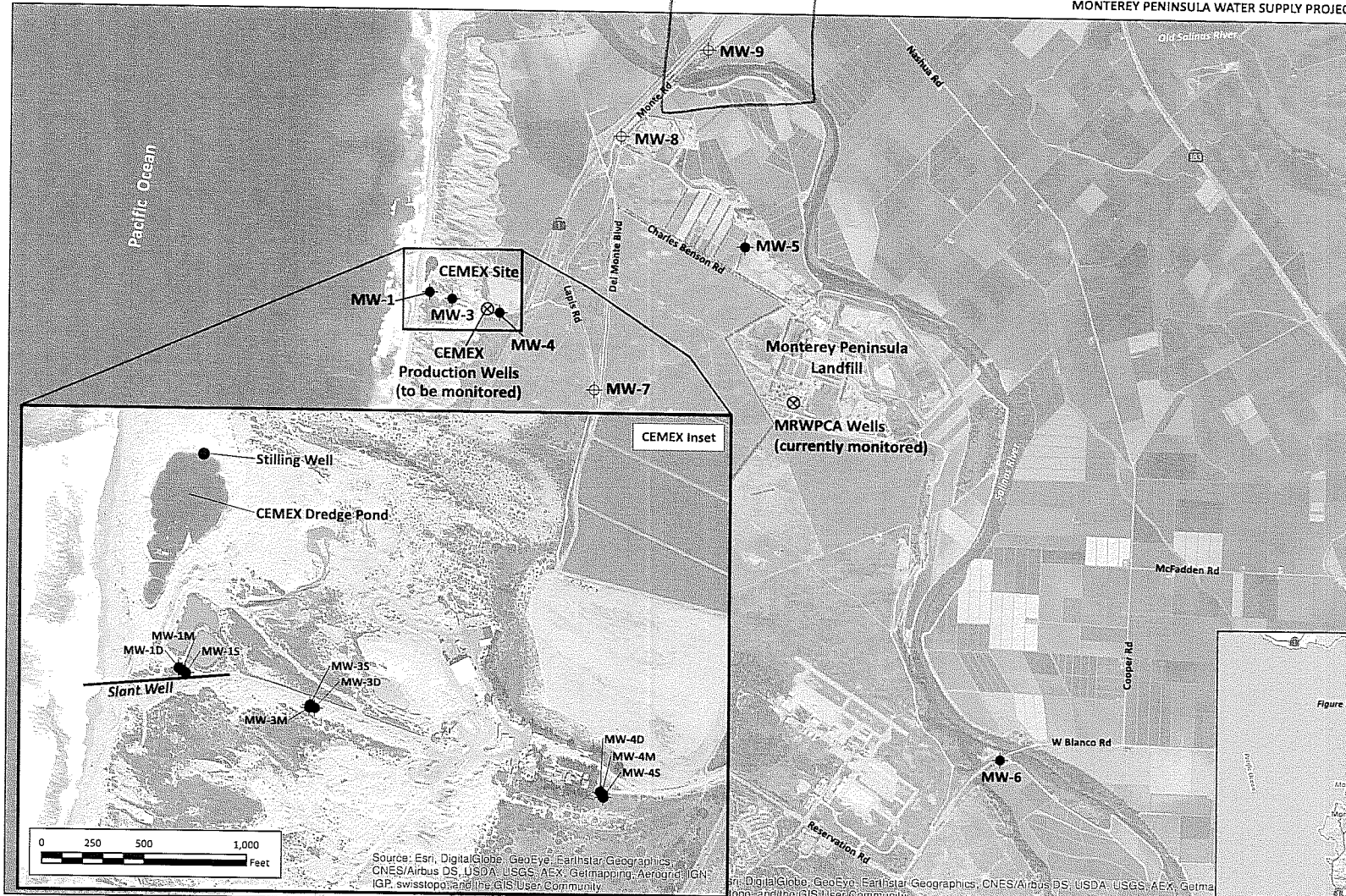
CALIFORNIA AMERICAN WATER

MONTEREY PENINSULA WATER SUPPLY PROJECT

EXISTING AND PROPOSED MONITORING WELL LOCATIONS

EXPLANATION

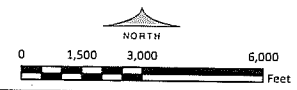
- Existing Monitoring Well Cluster
- ⊕ Proposed Monitoring Well Cluster
- ⊗ Existing Production Well
- Slant Well



Source: Esri, DigitalGlobe, GeoEye, Earthstar, Geographics, CNES/Airbus DS, USDA, USGS, AEX, Getmapping, Aerogrid, IGN, IGP, swisstopo, and the GIS User Community

Source: Esri, DigitalGlobe, GeoEye, Earthstar, Geographics, CNES/Airbus DS, USDA, USGS, AEX, Getmapping, Aerogrid, IGN, IGP, swisstopo, and the GIS User Community

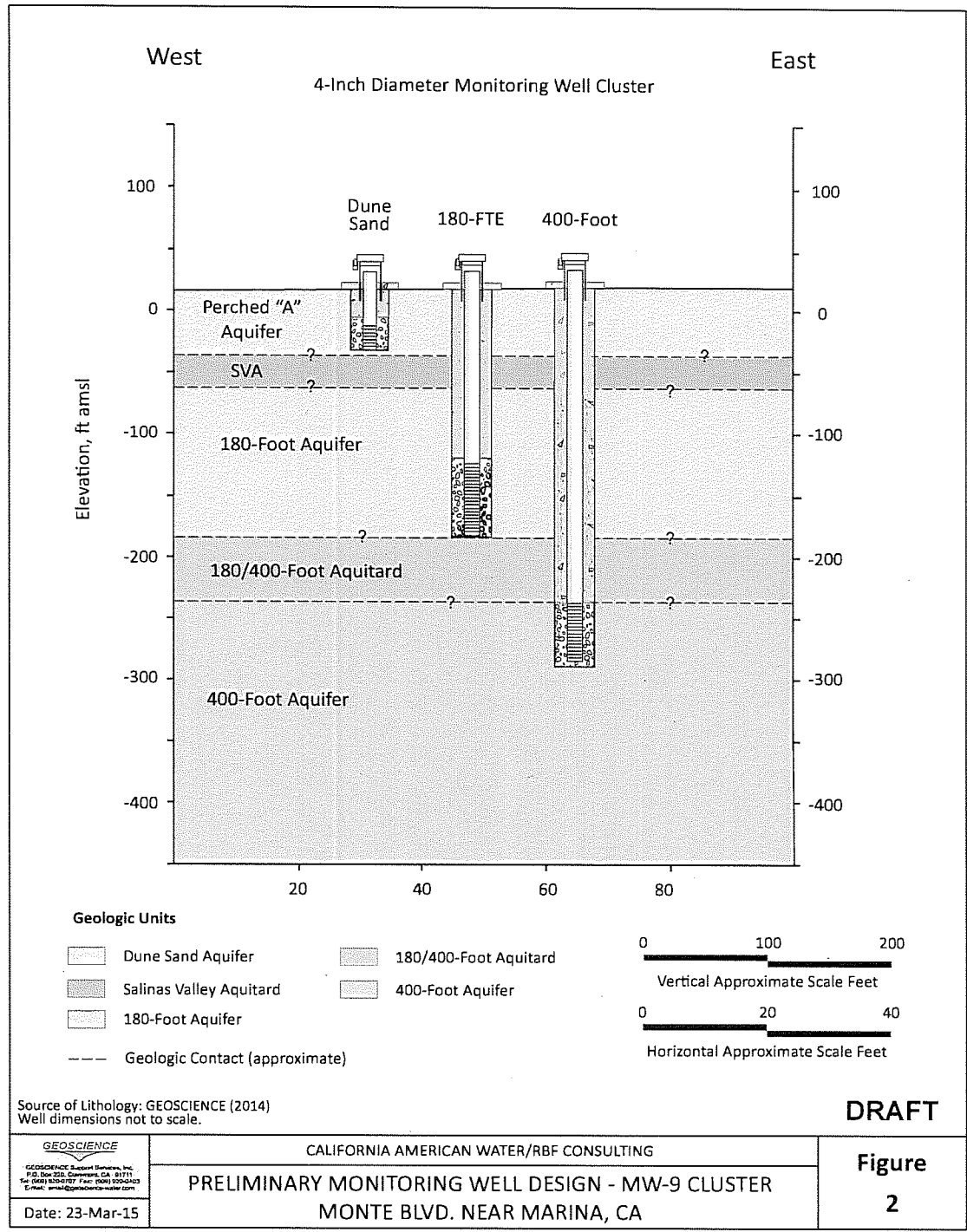
24-Mar-15
 Prepared by: DWB. Map Projection: State Plane 1983, Zone IV.
 © 2015, GEOSCIENCE Support Services, Inc. All rights reserved.



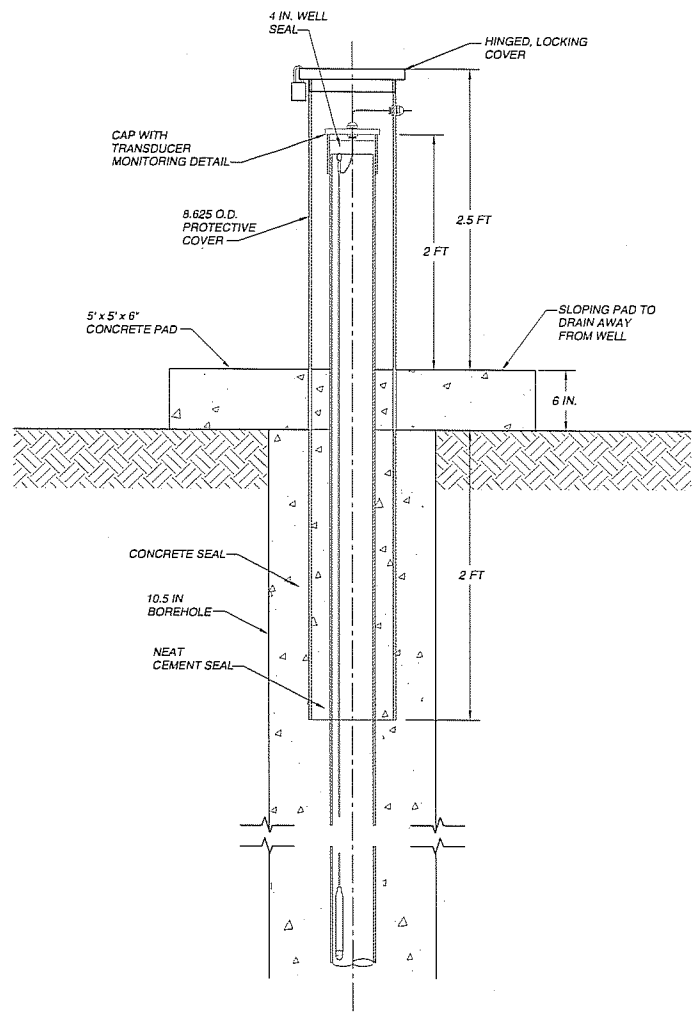
GEOSCIENCE
 GEOSCIENCE Support Services, Inc.
 P.O. Box 220, Claremont, CA 91711
 Tel: (909) 451-6550 Fax: (909) 451-6532
 www.gsswater.com

Figure 1

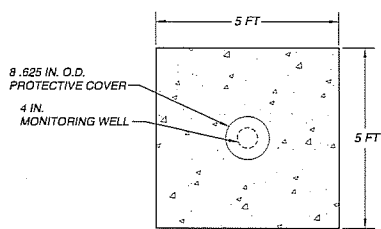
15-12503
Exhibit B p.1



15-12503
 Exhibit B_{pg 2}



PROFILE
 NOT TO SCALE



PLAN
 NOT TO SCALE

DRAFT

<p>SETTING THE STANDARD IN WATER WELL DESIGN SINCE 1973 909.451.6650 gswater.com</p>	MONTEREY PENINSULA WATER SUPPLY PROJECT	Date:	FIGURE
	PRELIMINARY MONITORING WELL DESIGN	Designed: MDW	3
	MONITORING WELL WELLHEAD DETAIL - MONUMENT COVER AND WELL PAD	Checked: DEW	
		File: MW-CLAMP-01.dwg	